



CATALOGO GENERALE 2023





PROFILO AZIENDALE

COMPANY PROFILE

KRINO è orgogliosa di poter proseguire, con il marchio LTI, una tradizione manifatturiera italiana con oltre 50 anni di esperienza. La storia del marchio ha infatti inizio il 10 Maggio 1961 a Milano, quando Giuseppe Crosa fonda l'azienda. In quel periodo l'industria meccanica italiana conosce un momento di rapida espansione e genera una crescente richiesta di accessori per le operazioni di assemblaggio. L'azienda si specializza nella produzione di inserti per l'avvitatura. LTI si mostra subito capace di fornire prodotti che uniscono, all'elevata precisione, riconosciute caratteristiche di affidabilità e ciò ne permette l'affermazione in ogni settore produttivo: dalle linee di montaggio del settore automobilistico ed elettrodomestico, all'elettronica e fabbricazione di componenti di arredamento. Nel 2011 Krino acquisisce il marchio LTI e trasferisce, nella propria sede di Monticello Brianza, l'officina di produzione con lo stesso personale qualificato, garanzia di qualità del prodotto e del servizio. La crescente richiesta di inserti sempre più performanti, conseguente alla diffusione degli utensili a batteria ad elevate prestazioni in ogni settore del mercato, fino al bricolage, impone la necessità di una continua ricerca di nuovi materiali e soluzioni tecniche in grado di soddisfare al meglio le richieste del mercato. Il nuovo catalogo LTI è il risultato dei processi innovativi messi in atto da KRINO abbinati alla garanzia di qualità del prodotto che ha da sempre contraddistinto LTI.

With the LTI brand, KRINO is proud to continue an Italian manufacturing tradition lasting more than 50 years. In fact, Giuseppe Crosa founded LTI on 10 May 1961 in Milan. In those years, the Italian mechanical industry was expanding rapidly, generating a growing demand for equipment and accessories for assembly lines. The company specialised in the production of bits for screwing applications. In no time at all, LTI proved to be capable of supplying products that combined high precision with proven reliability. This allowed it to become successful in every production sector: on the assembly lines of cars and electrical household appliances, in electronics and the manufacturing of decor and furniture items. In 2011, Krino purchased the LTI brand and its experience and moved the production centre to its headquarters in Monticello Brianza, while keeping the LTI qualified personnel as guarantee of the quality of the product and service. The growing demand for more and more efficient bits resulting from the widespread use of high-performance cordless tools in every sector of the market, as well as the increasing popularity of DIY projects, led to the constant search for new materials and technical solutions able to effectively meet the requirements of the market. In this catalogue LTI, offer the result of our research and technical innovations.

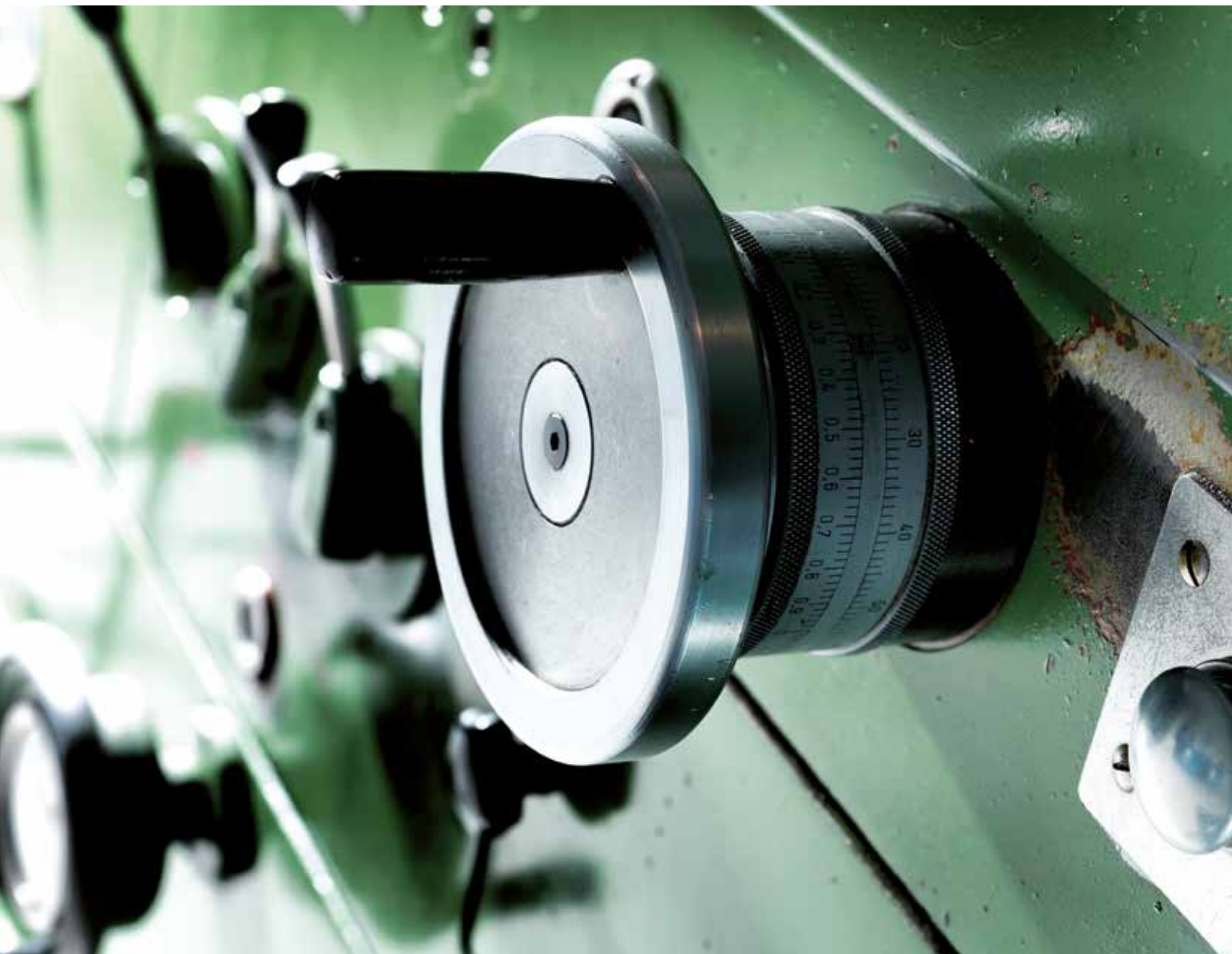

ESPERIENZA EXPERIENCE

Un archivio di migliaia di disegni, moltissimi casi di problem-solving sulle linee di montaggio e impianti di avvitatura automatici, la collaborazione con i produttori di utensili per avvitatura industriale e con le viterie; questo il bagaglio di conoscenze che rende il marchio LTI sinonimo di qualità ed elevata affidabilità del prodotto.

An archive with thousands of drawings and designs, numerous special tools made for assembly lines and automatic screwing systems, constant collaboration with tool manufacturers for industrial screwing applications, and with screw manufacturers. This wealth of knowledge makes the LTI brand synonymous with quality and high reliability

RICERCA RESEARCH

L'uso di avvitatori sempre più potenti, il bisogno di incrementare la produttività delle linee di montaggio, l'utilizzo di viti auto-formanti ed auto-perforanti anche su materiali estremamente duri ci spinge a cercare nuovi materiali con i quali poter ottimizzare il rapporto durezza/tenacità e nuove soluzioni produttive che possano offrire un ottimale accoppiamento tra vite ed inserto.

The use of more and more powerful screwdrivers, the need to increase productivity of the assembly lines, the use of self-forming and self-drilling screws even on extremely hard materials, inspires us to search for new materials that optimise the relationship between hardness and toughness and new production solutions that can offer excellent coupling between the screw and insert bit.

INNOVAZIONE INNOVATION

Su queste basi abbiamo fissato la progettazione e costruzione dei nuovi prodotti che offriamo, al mercato sia professionale che specialistico, in un'ampia varietà di materiali, proprietà tecniche, finiture e assortimenti, con un occhio di riguardo alle confezioni dedicate al punto vendita.

The design and manufacture of new products for the professional and specialist market is based on innovation. For this reason, our products are available in a wide variety of materials, technical properties, finishes and assortments with new packaging dedicated to stores.

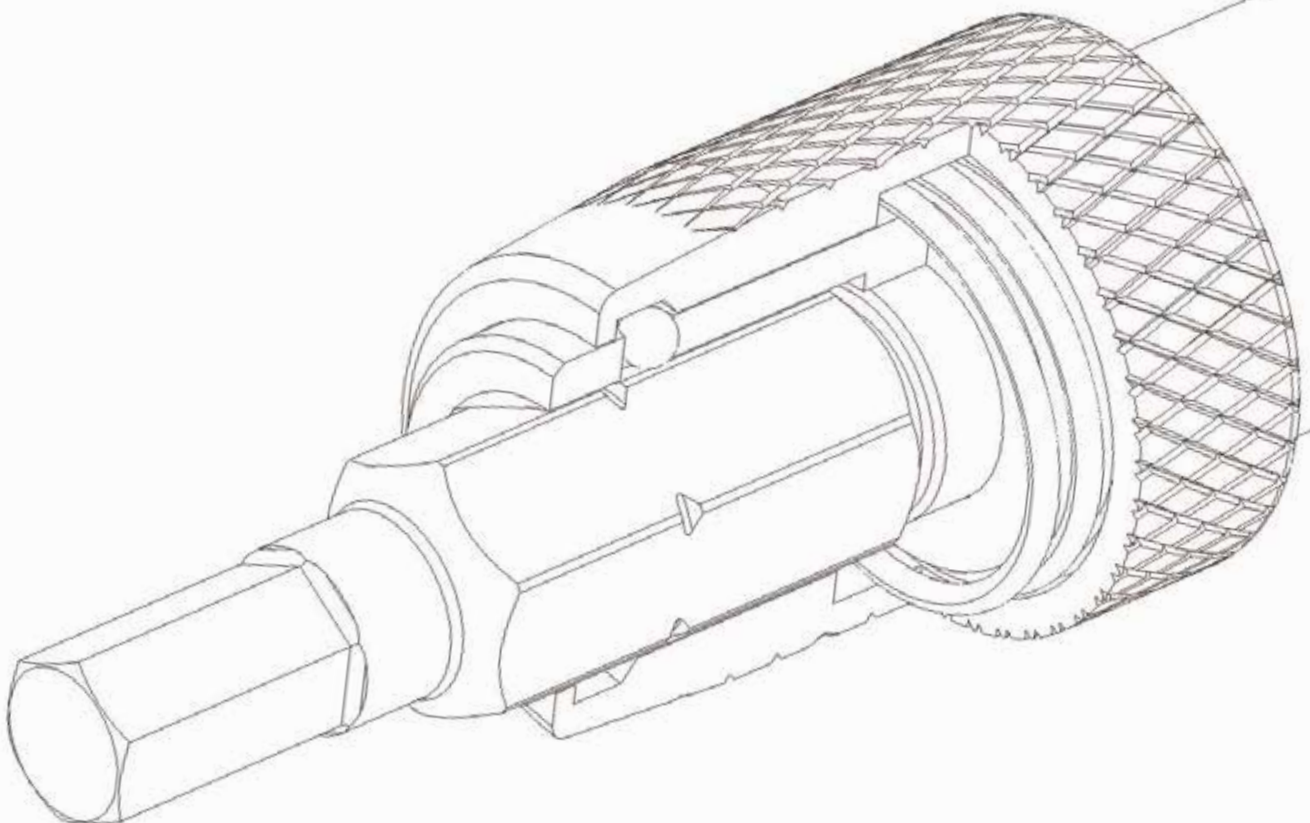

PROGETTAZIONE E SVILUPPO DESIGN AND DEVELOPMENT

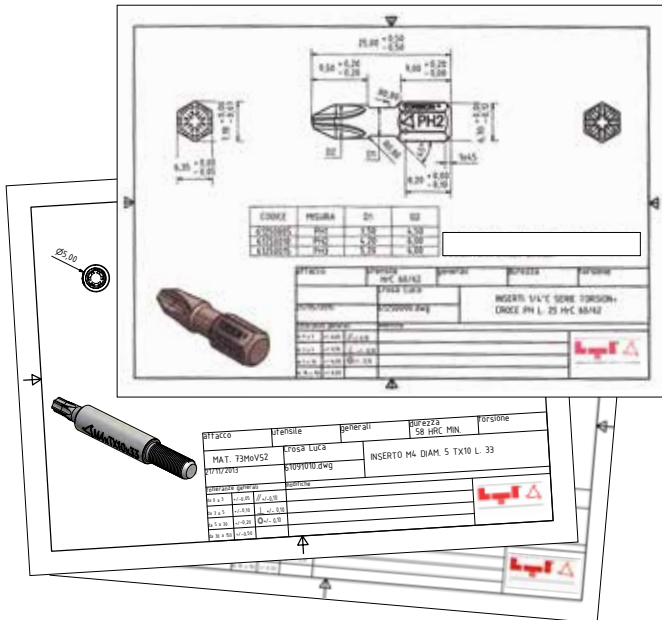

Il nostro ufficio tecnico è in grado progettare l'utensile più indicato alle esigenze dell'utilizzatore industriale e individuare, con l'aiuto del controllo qualità, il materiale ed il trattamento termico più idonei a garantire le migliori performances. Sviluppiamo un nuovo prodotto ogni due giorni.

Our technical office is able to design the tool best suited to the needs of the industrial user, and to identify, with the help of the quality service, the material and heat treatment best suited to ensure the best performances. We develop a new product every two days.

TORNITURA E PROFILATURA TURNING AND MILLING

Torni a CNC, per operazioni di elevata precisione, con i quali possiamo lavorare barre con diametri da 4mm a 20mm. Profilatrici specifiche per inserti. Questo il parco macchine di cui disponiamo per soddisfare le richieste della nostra clientela.

CNC lathes for high precision machining, which allows machining bars with diameters of 4mm to 20mm. Specific forming machines for bits. We have all the machinery to cater to the needs of our customers.



TEST DI QUALITÀ

QUALITY TEST

Il modernissimo e attrezzato laboratorio di controllo qualità garantisce l'intera produzione dei nostri utensili. Specifici e accurati controlli metallografici sull'acciaio che acquistiamo e sul prodotto che tempriamo assicurano elevate prestazioni dei nostri utensili nella sicurezza più completa.

The ultra-modern and well-equipped control laboratory guarantees the entire production of our tools. Specific and accurate metallographic controls on the steel that we purchase and on the product that we temper, ensures high performance of our tools in the utmost safety.

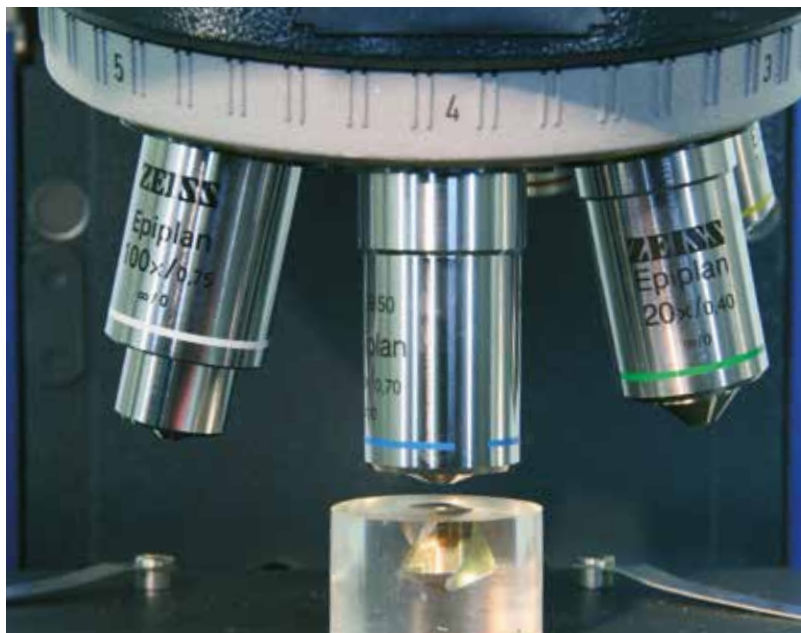

TRATTAMENTO TERMICO

HEAT TREATMENT



Siamo l'unica azienda in Italia e fra le poche in Europa a trattare internamente i propri inserti con un impianto di tempra sottovuoto. Questo tipo di tecnologia permette con assoluta certezza di evitare problemi di decarburazione ed ossidazione della superficie.

Internal heat treatment department: the only company in Italy and among the few in Europe to temper bits with a vacuum tempering plant. This type of technology prevents problems associated with oxidation and decarburisation of the surfaces

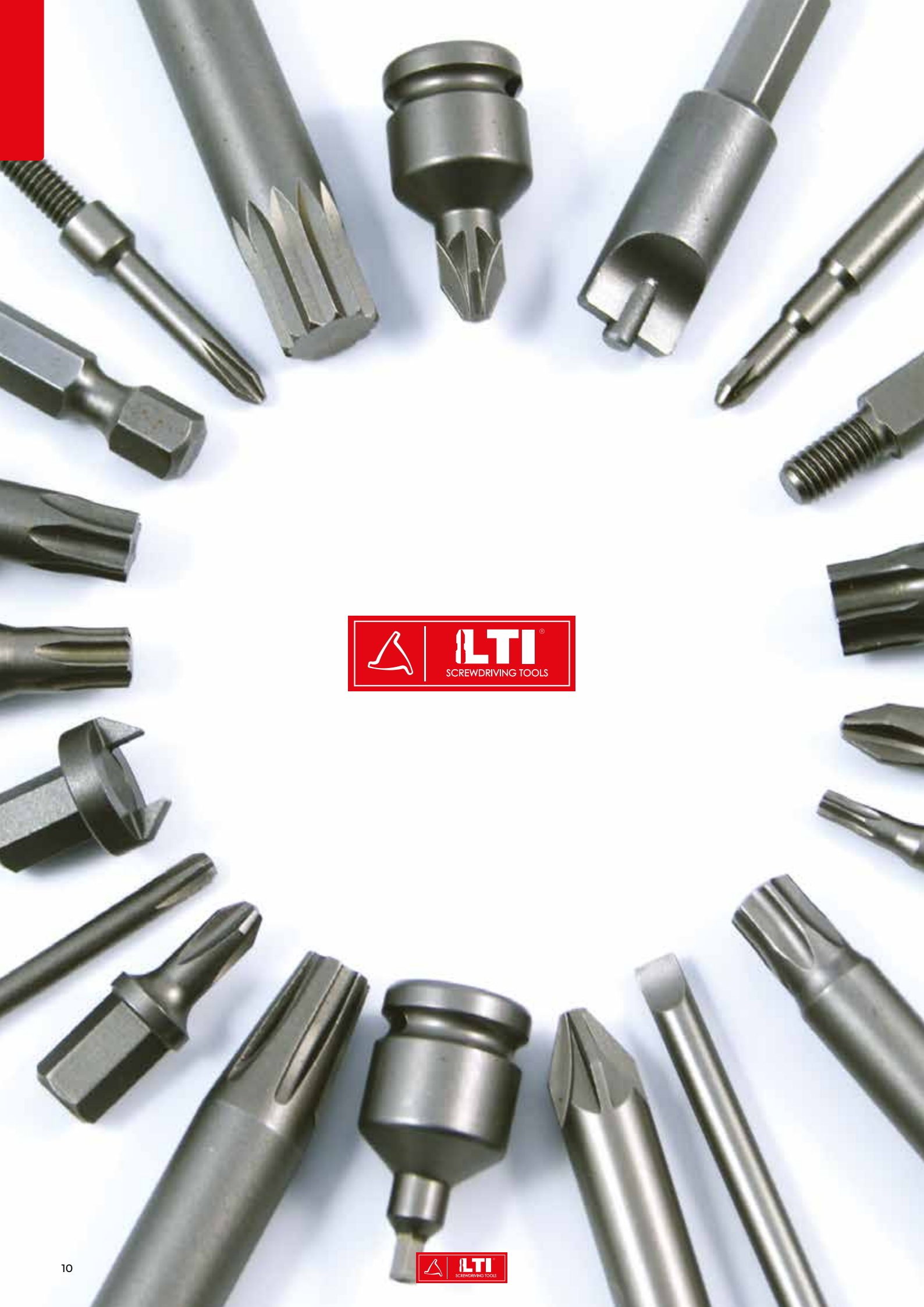

ARTICOLI SU RICHIESTA

CUSTOME-MADE ITEMS

La nostra azienda produce inserti per avvitatori secondo gli standard internazionali ma realizza anche prodotti su richiesta specifica e disegno del cliente anche per lotti di ridotta quantità. L'esperienza di cui dispongono i nostri tecnici è di supporto per la progettazione e la soluzione di ogni particolare necessità legate a operazioni di avvitatura su impianti automatici.

Tutte le lavorazioni meccaniche e il trattamento termico vengono eseguiti al nostro interno; per questo motivo garantiamo al nostro cliente massima flessibilità, un servizio custom fit ai massimi livelli per la realizzazione di prodotti di elevata qualità e specificità. Operiamo con successo nell'industria dei grandi elettrodomestici, delle catene di montaggio meccaniche, nei cantieri navali o aerospaziali; i nostri prodotti ogni giorno incontrano sfide importanti e i nostri clienti riconoscono il supporto costante e qualificato che offriamo loro.

Our company manufactures bits for drills and drivers in accordance with the international standards, as well as products to fit the exact specifications and requests of customers, including small quantities. The experience and expertise of our technicians supports the design and solution of each detail of automatic screwing operations.

The machining operations and heat treatments are all performed internally; for this reason, we are able to offer customers maximum flexibility, first-rate personalised service to create high quality and specific products. We work successfully in the field of household appliances, mechanical assembly lines, shipbuilding and aircraft production. Our products face important challenges every day and our customers recognise the constant and qualified support we offer them.

Scansiona i moduli a fine catalogo o scaricali dal sito www.lti-tools.com

Scan the forms at the end of the catalog or download them from www.lti-tools.com



Richiesta di preventivo - Get a quote
Inserti filettati - thread bits
 fino a 400mm di lunghezza - length up to 400mm

Richiesta di preventivo - Get a quote
Inserti speciali - special bits
 fino a 400mm di lunghezza - length up to 400mm

Quantità/Quantity

R Punta/Tip

M Abbotto/Drive

Caratteristiche/Features

Utensili specifici/Further specifications

KRINO GROUP



Per raggiungere l'eccellenza nel servizio alla clientela offriamo oggi la possibilità di realizzare set e valigette con contenuti specifici: il nostro parco macchine si è infatti ampliato con una fresatrice taglia spugne che consente la realizzazione di sedi dedicate per l'inserimento di utensili e accessori su esigenza del cliente.

To achieve excellence in customer service we can offer you to create sets and cases with specific contents: our machine fleet has in fact been expanded with a sponge milling machine that allows the creation of dedicated seats for the insertion of tools and accessories on customer's request.

Il cliente può personalizzare il contenuto del set scegliendo gli utensili desiderati e decidendo il colore della spugna nella quale saranno disposti.

The customer can customize the contents of the set by choosing the desired tools and deciding the color of the sponge in which they will be arranged.



PRESS AND MEDIA



BLOG.KRINO.IT

Ancora non conosci Mr. K?! Cercalo anche sul blog!
Blog.Krino.It

Mr. K è il nuovo paladino della ferramenta che ogni mese ci regala preziosi video con consigli e informazioni utili sui nostri prodotti!

*You still do not know Mr. K?! Look for it on the blog too!
Blog.Krino.It*

Mr. K is the new hardware champion who every month gives us precious videos with tips and useful information about our products!

LTI è presente anche sui social con tutorial, presentazioni di prodotto e tante altre idee, dimostrazione di un'azienda dinamica e al passo coi tempi che non si accontenta dei soliti standard comunicativi.

LTI is also present on social media with tutorials, product presentations and many other ideas, demonstration of a dynamic company that isn't satisfied with the usual communication standards.



TiFaForare

@KrinoTools



COME LEGGERE IL CATALOGO

HOW TO USE THE CATALOGUE

Argomento specifico
Specific topic

Indicazioni del capitolo
Chapter indications

Specifiche di prodotto
Product specifications

Indicazioni della famiglia prodotto
Indications of the product family

Confezionamento base
Basic packaging

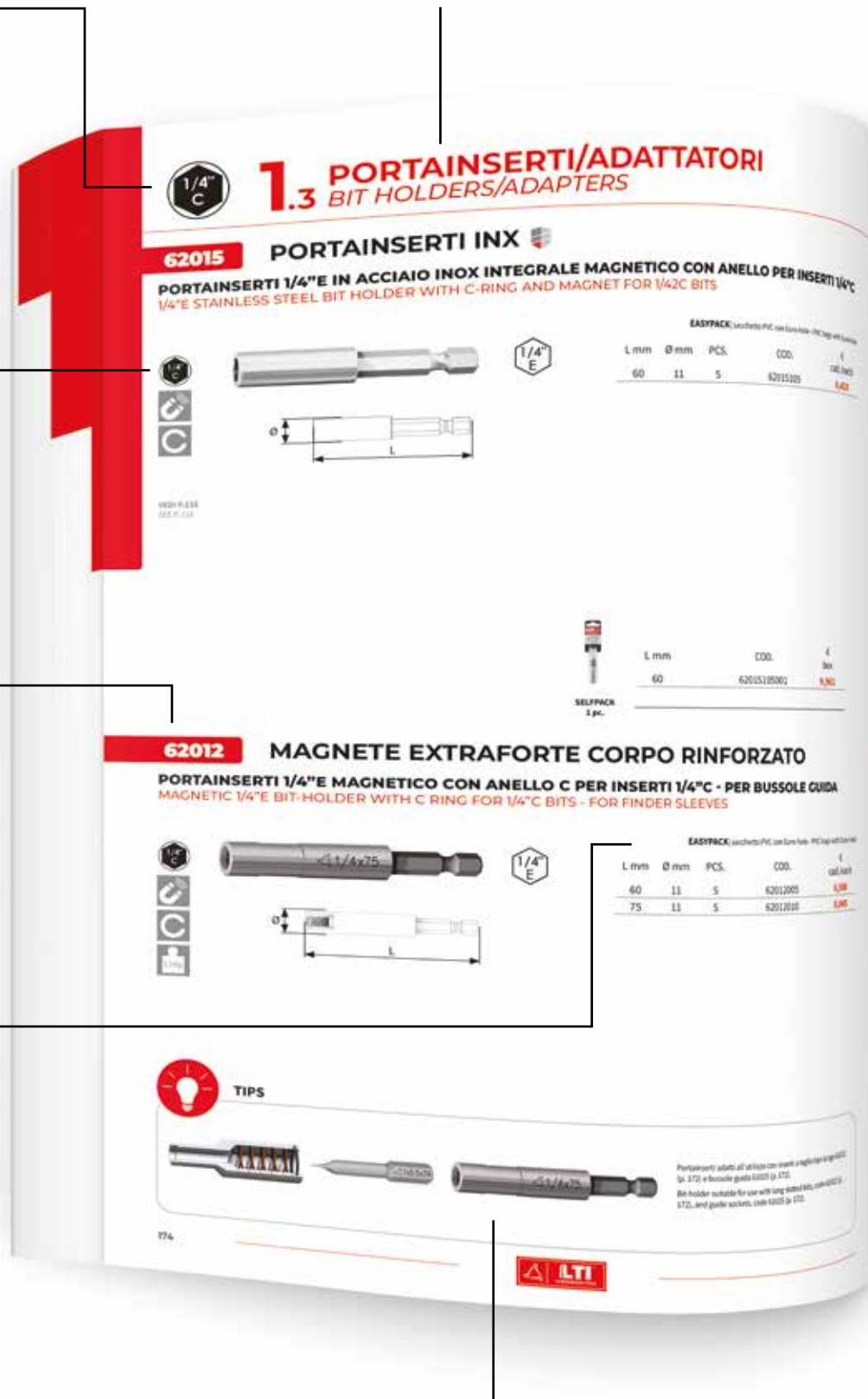

Descrizione del prodotto

Product description

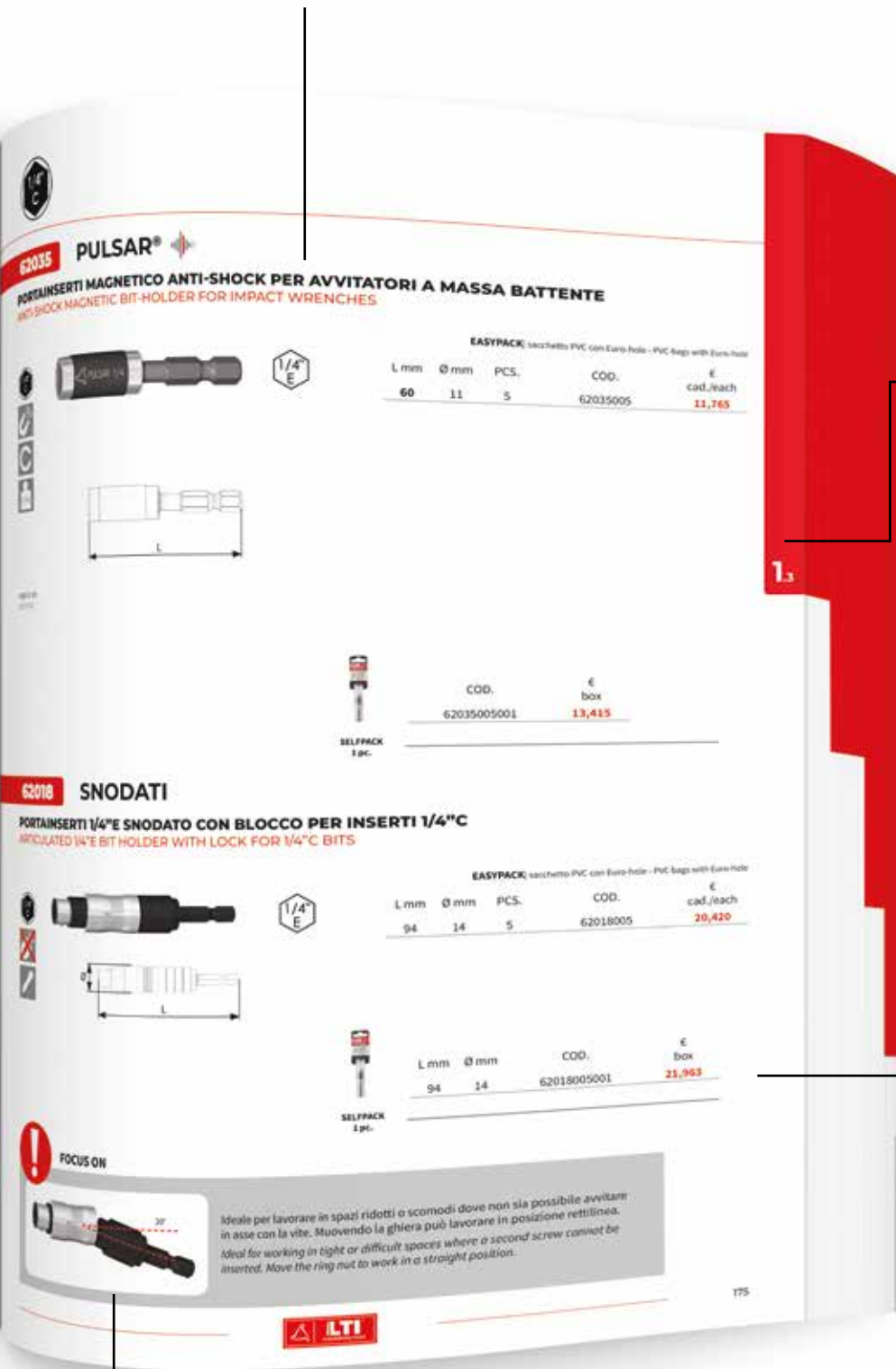

Indicazioni del capitolo
Chapter indications

Altri confezionamenti
Other packaging

Approfondimenti
In-depth studies

1

62013 MAGNETICI SENZA ANELLO 2

3 **PORTAINSERTI 1/4"E MAGNETICO PER INSERTI 1/4"C**
MAGNETIC 1/4"E BIT-HOLDER FOR 1/4"C BITS

4 **40/44 HRC**

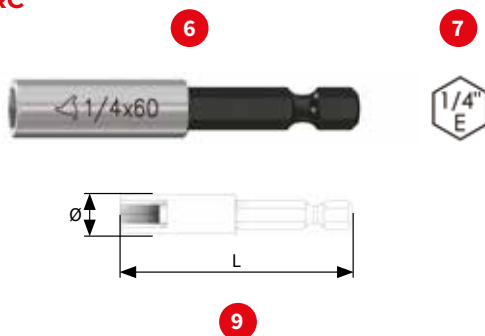
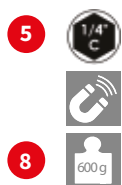

10 **EASYPACK** | sacchetto PVC con Euro-hole - PVC bags with Euro-hole

11	12	13	14
L mm	Ø mm	PCS.	COD.
50	10	5	62013004
60	10	5	62013005
75	10	5	62013010
100	10	5	62013015
120	10	5	62013020
150	10	5	62013025
200	10	5	62013030
250	10	5	62013035

€ cad./each



BOX
25 pcs.

L mm	COD.	€ box
50	62013004025	
60	62013005025	
75	62013010025	

15



SELPACK
1 pc.

11	13	16
L mm	COD.	€ box
50	62013004001	
60	62013005001	
75	62013010001	
100	62013015001	

Descrizione del prodotto

Product description

- | | | | | | |
|---|---|----|--|----|--|
| 1 | Indicazione della famiglia prodotto
Indication of the product family | 7 | Attacco
Attachment | 13 | Codice prodotto
Product Code |
| 2 | Prodotto presentato
Product presented | 8 | Specifiche di prodotto
Product specifications | 14 | Prezzo unitario
Unit price |
| 3 | Descrizione del prodotto
Product description | 9 | Disegno tecnico
Technical design | 15 | Altri confezionamenti
Other packaging |
| 4 | Caratteristiche tecniche
Technical features | 10 | Confezionamento base
Basic packaging | 16 | Prezzo per confezione
Price per pack |
| 5 | Impronta/innesto
Tip/connection | 11 | Misure specifiche
Specific measurements | | |
| 6 | Immagine del prodotto
Product image | 12 | Quantità minima d'acquisto
Minimum amount of purchase | | |

CONFEZIONAMENTO PACKAGING

5 - 10 pcs.



EASYPACK

1. Sacchetto PVC termosaldato con asola Euro-hole
2. Confezionamento in box di cartone

1. Heat-sealed PVC bag with Euro-hole
2. In cardboard box packaging

1 - 2 pcs.



SELFPACK

1. Tubo PP con tappo con asola Euro-hole
2. Clip PP appendibile con asola Euro-hole

1. PP tube with cap with Euro-hole
2. Hangable PP clip with Euro-hole

5 - 10 pcs.



MINIBOX

- Scatoletta PP richiudibile con asola Euro-hole

- Resealable PP box with Euro-hole

100 - 200 pcs.



1. TANK BOX 100 pcs.

- Barattolo PVC a vite con asola Euro-hole
- PVC screw jar with Euro-hole

2. BIG BAG 200 pcs.

- Sacchetto PVC richiudibile
- PVC resealable bag

APPROFONDIMENTI IN-DEPTH STUDIES



FOCUS ON

Approfondimenti specifici per prodotto: caratteristiche, indicazioni tecniche e curiosità.

Specific studies for product characteristics, technical specifications and peculiarities.



TIPS

Consigli di utilizzo e suggerimenti per usufruire al meglio dei nostri prodotti, alle condizioni più vantaggiose.

Tips and suggestions on how to best use our products, in the most favourable conditions.



LINEE PREMIUM
PREMIUM LINES

MAG-BIT+™	TORSION®	TITANIUM
COLOUR+	TORSION+	INX
PULSAR®	HDC	ACR®

IMPRONTE
TIPS

PH PHILLIPS®	ESAGONO SFERICO SPHERICAL HEXAGON	ASSI-SIT
PZ POZIDRIV®	ESAGONO FORATO HEXAGON WITH HOLE	RIBE
TX PER VITI TORX® FOR TORX® SCREWS	ESAGONO (POLLICI) HEXAGON (INCHES)	RIBE WITH HOLE
TXH PER VITI TORX® CON FORO FOR TORX® SCREWS WITH HOLE	TAGLIO SLOTTED	PENTALOBE
TW CONICO PER VITI TORX® TAPERED FOR TORX® SCREWS	PLUS/MINUS TAGLIO/PH PLUS/MINUS SLOT/PH	PH DOPPIO DOUBLE PH
TX TORX® WITH PIN	PLUS/MINUS TAGLIO/PZ PLUS/MINUS SLOT/PZ	PZ DOPPIO DOUBLE PZ
IP TORX-PLUS®	QUADRO SQUARE	DOPPI TAGLIO-PH DOUBLE SLOT-PH
PER VITI IPR FOR IPR SCREWS	SPANNER	DOPPI TAGLIO-PZ DOUBLE SLOT-PZ
ESAGONO MASCHIO MALE HEXAGON	TRI-WING	ESAGONO FEMMINA FEMALE HEXAGON
	TORQ-SET	PER BULLONI TORX® FOR TORX® BOLTS
	XZN	KM - KMA

























ATTACCHI FEMMINA
FEMALE DRIVES

	QUADRO SQUARE
	4mm C
	1/4" C
	1/4" E
	1/4"
	5/16" C
	5/16"
	7/16" E
	3/8" 10mm
	1/4"
	3/8"
	1/2"
	5/8"
	3/4"
	1"
	1-1/2"

SIMBOLI
SYMBOLS

	MAGNETICO MAGNETIC
	NON MAGNETICO NON-MAGNETIC
	TRATTENIMENTO MAGNETICO DELLA VITE SCREW-BLOCKING MAGNET
	TRATTENIMENTO MAGNETICO DELL'INSERTO BIT-BLOCKING MAGNET
	CON MANDRINO DI BLOCCO WITH LOCK CHUCK
	SGANCIO RAPIDO QUICK RELEASE
	CON SFERA WITH BALL
	CON ANELLO C WITH C RING
	TRATTENIMENTO HOLDING FORCE
	NUMERO DI DENTI NUMBER OF TEETH
	MAGNETE RETRAIBILE RETRACTABLE MAGNET
	TESTA SFERICA BALL-HEAD
	UTENSILE MANUALE HAND TOOL
	UTENSILE PER MACCHINA POWER TOOL

ATTACCHI MASCHIO
MALE DRIVES

	7mm
	SPINA PASSANTE THROUGH HOLE
	BSF 3/16x32
	1/4" C
	UNF 10x32
	M3
	M4
	M5
	M6
	FILETTATO THREADED
	ESAGONO HEXAGON
	3mm
	5,5mm
	5/16" C
	5/16"
	7/16" E
	3/8" 10mm
	4mm C
	1/4"
	3/8"
	1/2"
	5/8"
	3/4"
	1"
	1-1/2"

	VITE AUTOFILETTANTE PER LEGNO SELF-TAPPING SCREW FOR WOOD
	VITE AUTOFILETTANTE PER METALLO SELF-TAPPING SCREWS FOR METAL
	VITE AUTO-FORANTE SELF-DRILLING SCREWS

	A PERNO PIN
	B SFERA BALL
	C FORO HOLE



INSERTI 1/4" E ACCESSORI
1/4" BITS AND ACCESSORIES

p. 30

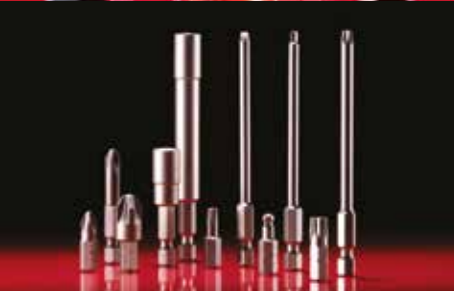

LINEE PREMIUM
PREMIUM LINES

p. 30



LINEE ESSENTIAL
ESSENTIAL LINES

p. 128

PORTAINSERTI/ADATTATORI
BIT HOLDERS/ADAPTERS

p. 196



INSERTI E CHIAVI SPECIALI
SPECIAL BITS AND SETTERS

p. 236



BUSSOLE E ACCESSORI
SOCKETS AND ACCESSORIES

p. 278



UTENSILI MANUALI
HAND TOOLS

p. 400



MODULI ESPOSITIVI
WALL DISPLAY SYSTEM

p. 470



SCHEDE TECNICHE
TECHNICAL DATASHEETS

p. 476

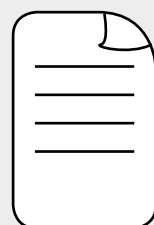

1

1.1

1.2

1.3

2

3

4

1.1

p. 30

LINEE PREMIUM PREMIUM LINES

MAG-Bit+™
 p. 32

 p. 36

COLOUR+
 p. 40

 p. 44

 p. 52

PULSAR®
 p. 57

 p. 58

TORSION®
 p. 66

 p. 70

TORSION+
 p. 78

 p. 82

HDC
 p. 90

 p. 94

TITANIUM
 p. 102

 p. 106

INX
 p. 114

 p. 118

 p. 119

ACR®
 p. 124

1.2

p. 128

LINEE ESSENTIAL ESSENTIAL LINES

  p. 132

  p. 138

  p. 142

  p. 144

  p. 146

  p. 147

  p. 148

  p. 148

  p. 150

  p. 152

  p. 153

  p. 153

  p. 154

  p. 158

  p. 159

  p. 160

  p. 161

  p. 162

  p. 163

  p. 164

  p. 165

  p. 166

  p. 166

  p. 167

  p. 167

  p. 168

CHIAVI A BUSSOLA NUT SETTERS

  p. 188

 p. 193

1.3

PORTAINSERTI/ ADATTATORI

p. 196

BIT HOLDERS/ADAPTERS

PORTAINSERTI 1/4" C

BIT HOLDERS



PORTAINSERTI 1/4" E

BIT HOLDERS



RINVII ANGOLARI

ANGLE DRIVERS



ADATTATORI

ADAPTERS



ACCESSORI

ACCESSORIES



2

p. 236

INSERTI E CHIAVI SPECIALI

SPECIAL BITS AND SETTERS

















INSERTI SPECIALI

SPECIAL BITS



		p. 268
		p. 269
		p. 270
		p. 270
		p. 271
		p. 271

CHIAVI SPECIALI
SPECIAL SETTERS

		p. 272
		p. 272
		p. 273
		p. 273
		p. 274
		p. 275
		p. 276
		p. 277
		p. 277

3





















p. 278
BUSSOLE E ACCESSORI
SOCKETS AND ACCESSORIES

IMPACT















		p. 281
		p. 284
		p. 286
		p. 288
		p. 294
		p. 297
	KMA 	p. 300
	KM 	p. 303
		p. 306
		p. 309
		p. 312
		p. 314

		p. 316
		p. 317

CHROME

		p. 321
		
		p. 325
		
		p. 328
		p. 331
		p. 334
		
		p. 341
		
		p. 346
		p. 349
		p. 352
		
		p. 359
		
		p. 368
		p. 370

	p. 372
	
	p. 373
	p. 375
	p. 374
	p. 376

	p. 426
	p. 427
	p. 428
	p. 434
	p. 440
	p. 442
	p. 444
	p. 446
	p. 448
	p. 452
	p. 454
	p. 456
	p. 457
	p. 457
	p. 461

4

p. 400
UTENSILI MANUALI
HAND TOOLS

	p. 402
	p. 408
	p. 410
	p. 412
	p. 418
	p. 419
	p. 420
	p. 424

p. 468
MODULI ESPOSITIVI
WALL DISPLAY SYSTEM



































































































p. 474
SCHEDE TECNICHE
TECHNICAL DATASHEETS

p. 486
INDICE PER CODICE
PROGRESSIVO
INDEX FOR PROGRESSIVE
CODES

GUIDA ALLA SCELTA - INSERTI E CHIAVI

GUIDE TO CHOOSING THE MOST SUITABLE PRODUCT - BITS AND SETTERS



























													
													
	p. 33	p. 41	p. 53	p. 67	p. 79	p. 91	p. 103	p. 115	p. 125	p. 132			
	p. 34	p. 42	p. 54	p. 68	p. 80	p. 92	p. 104	p. 115	p. 126	p. 138			
	p. 35	p. 43	p. 55	p. 69	p. 81	p. 93	p. 105	p. 116		p. 142			
										p. 144			
										p. 146			
										p. 147			
										p. 148			
										p. 148			
			p. 56					p. 116		p. 150			
										p. 152			
										p. 153			
										p. 153			
						p. 93	p. 105	p. 117		p. 154			
										p. 158			
										p. 159			
										p. 160			
										p. 161			
										p. 162			
										p. 163			
										p. 164			
										p. 165			
													
													
												p. 166	
												p. 166	
												p. 167	
												p. 167	
													p. 188

													
		p. 246	p. 251	p. 258	p. 260	p. 262	p. 264	p. 266	p. 270		p. 268		
		p. 246		p. 258	p. 260	p. 262	p. 264	p. 266		p. 270	p. 268		
	p. 241	p. 248	p. 251	p. 258	p. 261	p. 262	p. 264						
	p. 241				p. 260								
													
													
													
													
	p. 240	p. 247	p. 251								p. 268	p. 267	
													
													
													
		p. 247	p. 252										
													
													
													
													
													
													
	p. 240												
													
	p. 242												
	p. 242												
			p. 252										
													p. 271
													p. 271
													
													
													



VEDI P. 127
 SEE P. 127

COME SCEGLIERE L'INSERTO PREMIUM
 HOW TO CHOOSE THE RIGHT PREMIUM BIT

- | | | |
|--|--|---|
|  HRC Durezza
Hardness |  S2 Acciaio S2
S2 steel |  Con avvitatori a impulsi
Impact and pulse wrenches |
|  Tenacità
Tough |  S3 Acciaio S3
S3 steel |  Utilizzi intensivi
Intensive use |
|  Elasticità
Elasticity |  Inox Acciaio INOX
Stainless steel |  Maggior vita dell'utensile
Longer tool life |
|  Utilizzo
Use |  Zn + PO₄ Fosfatazione allo zinco
Zinc phosphates |  Riconoscimento visivo
Visual recognition |
|  Acciaio e finitura
Steel and surface finish |  Mn + PO₄ Fosfatazione al manganese
Manganese phosphates |  Trattenimento magnetico
Magnetic retention |
|  Speciale per
Special for |  Rivestimento ambrato
Amber coated |  Per viti usurate
Worn screws |
|  Utilizzi generali
General uses |  Rivestimento bluettato anti-usura
Anti-wear blued coated |  Grip
Grip |
|  A mano
By hand |  TiN Rivestimento al Nitruro di Titanio
Titanium Nitride coated |  Utilizzi in ambienti marini
Use in marine environments |
| |  Rivestimento in polvere di diamante
Diamond powder coated |  INOX Per viti INOX
For stainless steel screws |

CHOOSE YOUR BIT	HRC						
PULSAR® TOP	★★★☆☆	★★★★★	★★★★★	★★★★★		S3 Mn + PO ₄	impact p. 52
TORSION+ TOP	★★★★★	★★★★★	★★★★★	★★★★★		S3	 p. 78
TORSION® TOP	★★☆☆☆	★★★☆☆	★★★☆☆	★★★☆☆		S2	 p. 66
MAG-Bit+™ SPECIAL	★★★☆☆	★★★☆☆	★★★☆☆	★★★☆☆		S2 Zn + PO ₄	 p. 32
TITANIUM SPECIAL	★★★★★	★★☆☆☆	★★☆☆☆	★★☆☆☆		S2 TiN	 p. 102
HDC SPECIAL	★★★☆☆	★★☆☆☆	★★☆☆☆	★★☆☆☆		S2	 p. 90
ACR® BASIC	★★★☆☆	★★☆☆☆	★★☆☆☆	★★☆☆☆		S2 Zn + PO ₄	 p. 124
INX BASIC	★★☆☆☆	★★☆☆☆	★★☆☆☆	★★☆☆☆		Inox	 p. 114
COLOUR+ BASIC	★★★☆☆	★★☆☆☆	★★★☆☆	★★★☆☆		S2 Zn + PO ₄	 p. 40
ESSENTIAL BASIC	★★★☆☆	★★☆☆☆	★★☆☆☆	★★☆☆☆		S2 Zn + PO ₄	p. 129



Nel campo dell'avvitatura, applicazioni sempre più specifiche e avvitatori a batteria sempre più potenti richiedono utensili con caratteristiche adeguate a ciascuna particolare situazione ed in grado di garantire performances sempre più elevate. Le linee PREMIUM che presentiamo in questa prima sezione, sono il frutto dell'evoluzione di questi ultimi anni di lavoro in KRINO, dove l'esperienza e la conoscenza che contraddistinguono il marchio LTI, sono state valorizzate e sviluppate dai nostri ingegneri per offrire una gamma di prodotti all'altezza delle aspettative.

Increasingly more specific applications and powerful battery-operated drivers require the use of tools with the appropriate characteristics, able to guarantee the highest performances at all times. The PREMIUM lines featured in this first section come from the evolution over the years and KRINO's constant commitment to research. Our engineers have capitalised and built on the long experience and knowledge characterising the history of LTI to offer new innovative product lines for numerous projects and applications.



1.1

LINEE PREMIUM PREMIUM LINES



MAG-Bit+™
INSERTI 1/4" CON SISTEMA DI TRATTENIMENTO MAGNETICO
1/4" BITS WITH MAGNETIC RETENTION SYSTEM

p. 32



COLOUR+
INSERTI 1/4" CON ANELLO COLORATO
1/4" COLORED RING BITS

p. 40



PULSAR®
INSERTI 1/4" PER AVVITATORI A MASSA BATTENTE
1/4" BITS FOR IMPACT WRENCHES

p. 52



TORSION®
INSERTI 1/4" TENACI RESISTENTI A COPPIE ELEVATE
1/4" HEAVY DUTY BITS, HIGH TORQUES RESISTANT

p. 66



TORSION+
INSERTI EXTRA HARD 1/4" RESISTENTI A COPPIE ELEVATE
1/4" EXTRA-HARD BITS TORQUES RESISTANT

p. 78



HDC
INSERTI 1/4" CON RIVESTIMENTO AL DIAMANTE
1/4" BITS WITH DIAMOND COATING

p. 90



TITANIUM
INSERTI 1/4" CON RIVESTIMENTO AL NITRURO DI TITANIO
1/4" BITS WITH TITANIUM NITRIDE COATING

p. 102



INX
INSERTI 1/4" REALIZZATI IN ACCIAIO INOX
1/4" STAINLESS STEEL BITS

p. 114



ACR®
INSERTI 1/4" CON CRESTE ANTISCIVOLAMENTO
1/4" BITS WITH NON-SLIP RIDGES

p. 124

MAG-Bit+™



INSERTI CON SISTEMA DI TRATTENIMENTO MAGNETICO
1/4" bits with magnetic retention system

MAG-Bit+™ system



500g
TX10 - TX15

600g
PH1 - PZ1
TX20 - TX25

750g
PH2 - PH3
PZ2 - PZ3
TX27 - TX30

800g
TX40

Utilizzo Use

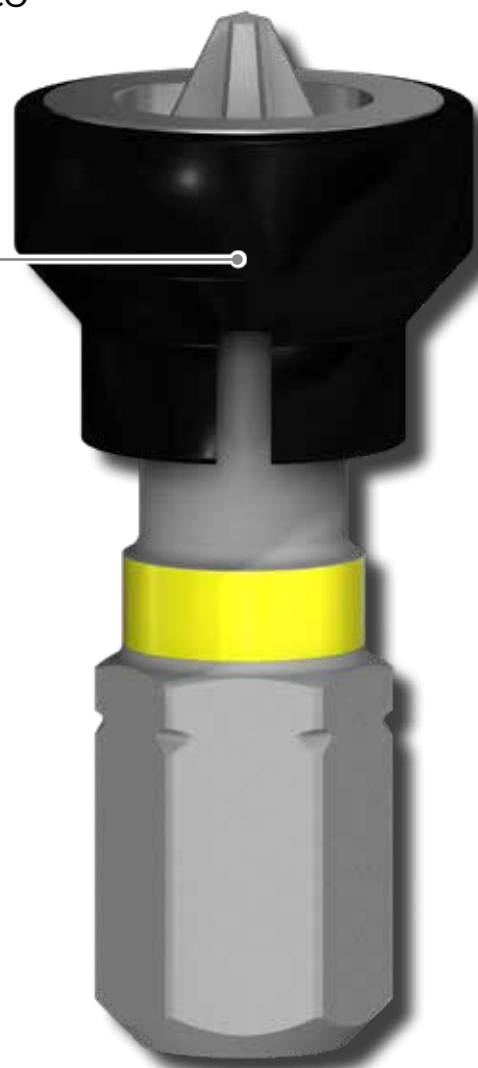
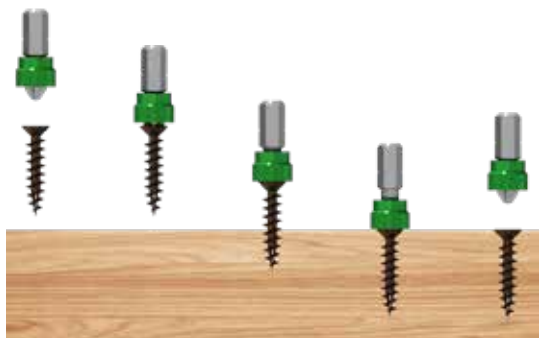

Applicazioni
applications

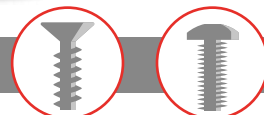

Trattenimento magnetico in quattro diversi formati e capacità per adattarsi correttamente ad ogni tipo e dimensione di vite.

Magnetic retention system in four different sizes and capacities able to hold any type and size of screw.



Codice colore per un riconoscimento facile e immediato sia della misura che del tipo di impronta.

COLOUR code for easy and immediate recognition of the size and profile of screw.



Sistema di trattenimento semplice e innovativo per risolvere molti problemi di avvitatura nel settore professionale.

Innovative simple retention system to solve many screwdriving problems in the professional sector.

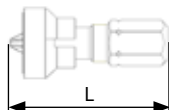
**61355****PH MAG-Bit+™ U****INSERTI 1/4" C PHILLIPS® CON TRATTENIMENTO MAGNETICO E CODICE COLORE**
1/4" C PHILLIPS® BITS WITH MAGNETIC RETENTION AND COLOR CODE**58/60 HRC**

EASYPACK | sacchetto PVC con Euro-hole • PVC bags with Euro-hole

	L mm	PCS.	COD.	€ cad./each
PH1	25	10	61355005	2,291
PH2	25	10	61355010	2,291
PH3	25	10	61355015	2,291

SELFPACK
2 pcs.

	L mm	COD.	€ box
PH1	25	61355005002	6,097
PH2	25	61355010002	6,097
PH3	25	61355015002	6,097

MINIBOX
10 pcs.

	L mm	COD.	€ box
PH1	25	61355005010	24,024
PH2	25	61355010010	24,024
PH3	25	61355015010	24,024

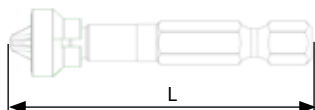
61356**PH MAG-Bit+™ U****LAME 1/4" E PHILLIPS® CON TRATTENIMENTO MAGNETICO E CODICE COLORE**
1/4" E PHILLIPS® POWER BITS WITH MAGNETIC RETENTION AND COLOR CODE**58/60 HRC**

EASYPACK | sacchetto PVC con Euro-hole • PVC bags with Euro-hole

	L mm	PCS.	COD.	€ cad./each
PH1	50	5	61356005	2,834
PH2	50	5	61356010	2,834
PH3	50	5	61356015	2,834

SELFPACK
2 pcs.

	L mm	COD.	€ box
PH1	50	61356005002	7,203
PH2	50	61356010002	7,203
PH3	50	61356015002	7,203

MINIBOX
5 pcs.

	L mm	COD.	€ box
PH1	50	61356005005	14,907
PH2	50	61356010005	14,907
PH3	50	61356015005	14,907



1. LINEE PREMIUM

PREMIUM LINES

61365

PZ MAG-Bit+™ U

INSERTI 1/4" C POZIDRIV® CON TRATTENIMENTO MAGNETICO E CODICE COLORE
1/4" C POZIDRIV® BITS WITH MAGNETIC RETENTION AND COLOR CODE

58/60 HRC

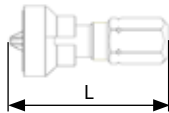
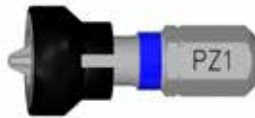

EASYPACK | sacchetto PVC con Euro-hole • PVC bags with Euro-hole

	L mm	PCS.	COD.	€ cad./each
PZ1	25	10	61365005	2,291
PZ2	25	10	61365010	2,291
PZ3	25	10	61365015	2,291



SELFPACK
2 pcs.

	L mm	COD.	€ box
PZ1	25	61365005002	6,097
PZ2	25	61365010002	6,097
PZ3	25	61365015002	6,097



MINIBOX
10 pcs.

	L mm	COD.	€ box
PZ1	25	61365005010	24,024
PZ2	25	61365010010	24,024
PZ3	25	61365015010	24,024

61366

PZ MAG-Bit+™ U

LAME 1/4" E POZIDRIV® CON TRATTENIMENTO MAGNETICO E CODICE COLORE
1/4" E POZIDRIV® POWER BITS WITH MAGNETIC RETENTION AND COLOR CODE

58/60 HRC

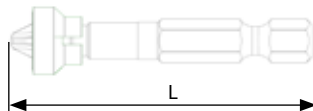

EASYPACK | sacchetto PVC con Euro-hole • PVC bags with Euro-hole

	L mm	PCS.	COD.	€ cad./each
PZ1	50	5	61366005	2,834
PZ2	50	5	61366010	2,834
PZ3	50	5	61366015	2,834



SELFPACK
2 pcs.

	L mm	COD.	€ box
PZ1	50	61366005002	7,203
PZ2	50	61366010002	7,203
PZ3	50	61366015002	7,203



MINIBOX
5 pcs.

	L mm	COD.	€ box
PZ1	50	61366005005	14,907
PZ2	50	61366010005	14,907
PZ3	50	61366015005	14,907

**61375****TX MAG-Bit+™ U**

INSERTI 1/4" C PER VITI TORX® CON TRATTENIMENTO MAGNETICO E CODICE COLORE
1/4" C BITS FOR TORX® SCREWS WITH MAGNETIC RETENTION AND COLOR CODE

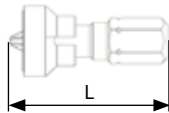
58/60 HRC

EASYPACK | sacchetto PVC con Euro-hole - PVC bags with Euro-hole

	L mm	PCS.	COD.	€ cad./each
TX10	25	10	61375005	2,784
TX15	25	10	61375010	2,784
TX20	25	10	61375015	2,784
TX25	25	10	61375020	2,784
TX27	25	10	61375025	2,784
TX30	25	10	61375030	2,784
TX40	25	10	61375035	2,784

	L mm	COD.	€ box
TX10	25	61375005002	7,146
TX15	25	61375010002	7,146
TX20	25	61375015002	7,146
TX25	25	61375020002	7,146
TX27	25	61375025002	7,146
TX30	25	61375030002	7,146
TX40	25	61375035002	7,146

SELFPACK
2 pcs.MINIBOX
10 pcs.

	L mm	COD.	€ box
TX10	25	61375005010	29,322
TX15	25	61375010010	29,322
TX20	25	61375015010	29,322
TX25	25	61375020010	29,322
TX27	25	61375025010	29,322
TX30	25	61375030010	29,322
TX40	25	61375035010	29,322

61376**TX MAG-Bit+™ U**

LAME 1/4" E PER VITI TORX® CON TRATTENIMENTO MAGNETICO E CODICE COLORE
1/4" E POWER BITS FOR TORX® SCREWS WITH MAGNETIC RETENTION AND COLOR CODE

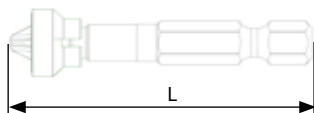
58/60 HRC

EASYPACK | sacchetto PVC con Euro-hole - PVC bags with Euro-hole

	L mm	PCS.	COD.	€ cad./each
TX10	50	5	61376005	3,425
TX15	50	5	61376010	3,425
TX20	50	5	61376015	3,425
TX25	50	5	61376020	3,425
TX27	50	5	61376025	3,425
TX30	50	5	61376030	3,425
TX40	50	5	61376035	3,425

	L mm	COD.	€ box
TX10	50	61376005002	8,424
TX15	50	61376010002	8,424
TX20	50	61376015002	8,424
TX25	50	61376020002	8,424
TX27	50	61376025002	8,424
TX30	50	61376030002	8,424
TX40	50	61376035002	8,424

SELFPACK
2 pcs.MINIBOX
5 pcs.

	L mm	COD.	€ box
TX10	50	61376005005	17,987
TX15	50	61376010005	17,987
TX20	50	61376015005	17,987
TX25	50	61376020005	17,987
TX27	50	61376025005	17,987
TX30	50	61376030005	17,987
TX40	50	61376035005	17,987



1. LINEE PREMIUM PREMIUM LINES

66002

MYBIT 7 ASSORTIMENTI MAG-Bit+™

ASSORTIMENTO 7 PCS. - INSERTI + PORTAINSERTI
7 PCS. SET - BITS + BIT HOLDER



7
pcs.

COD. **66002445**

€ 22,915

61355		61365		61375	
PH1	PH2	PZ1	PZ2	TX25	TX30
1pc.	1pc.	1pc.	1pc.	1pc.	1pc.



100 X 120 mm



INCLUSO
INCLUDED
COD. 62013005



66002

DISPLAY MYBIT 7 MAG-Bit+™

ESPOSITORE DA BANCO PER 12 BIT-SET
12 PCS. BIT-SET DISPLAY



12
pcs.

COD. **66002449**

€ 262,248



12 pcs.
COD. 66002445

150 X 40 X 195 mm



66001

STORE 9 ASSORTIMENTI MAG-Bit+™

CASSETTIERA CON 9 SCOMPARTI PER ESPOSITORE MULTISTORE
DRAWERS WITH 9 COMPARTMENTS FOR MULTISTORE DISPLAY

COD. **66001080**

€ 242,827

110
pcs.



600 X 90 X 65 mm

61355			61365		61375			
PH1	PH2	PH3	PZ1	PZ2	TX20	TX25	TX30	TX40
10pcs.	20pcs.	10pcs.	10pcs.	20pcs.	10pcs.	10pcs.	10pcs.	10pcs.



MULTI STORE

COD. 66001005VC

PER DETTAGLI E COMPOSIZIONE VEDERE P. 184
FOR DETAILS AND COMPOSITION SEE p.184

L'utilizzo degli inserti MAG-Bit+ permette di lavorare con una mano libera.
The use of MAG-Bit+ bits allows you to work with a free hand.





1. LINEE PREMIUM

PREMIUM LINES

66001

MULTI **BIT** ESPOSITORE INSERTI MAG-Bit+™

ESPOSITORE DA BANCO CON 25 SCOMPARTI
DISPLAY WITH 25 COMPARTMENTS



260
pcs.

COD. **66001340**

€ 754,992

61355



PH1 10pcs.	PH2 20pcs.	PH3 10pcs.
---------------	---------------	---------------

61365



PZ1 10pcs.	PZ2 20pcs.	PZ3 10pcs.
---------------	---------------	---------------

61375



TX10 10pcs.	TX15 10pcs.	TX20 10pcs.	TX25 20pcs.	TX30 20pcs.	TX40 20pcs.
----------------	----------------	----------------	----------------	----------------	----------------

61356



PH1 5pcs.	PH2 10pcs.	PH3 5pcs.
--------------	---------------	--------------

61366



PZ1 5pcs.	PZ2 10pcs.	PZ3 5pcs.
--------------	---------------	--------------

61376



TX10 5pcs.	TX15 5pcs.	TX20 5pcs.	TX25 10pcs.	TX30 10pcs.	TX40 10pcs.
---------------	---------------	---------------	----------------	----------------	----------------

62018005



5pcs.

445 X 465 X 210 mm

STRUTTURA IN POLIPROPILENE ALVEOLARE AUTOPORTANTE, 25 SCOMPARTI.
 SELF-SUPPORTING POLYPROPYLENE HONEYCOMB STRUCTURE, 25 COMPARTMENTS.

**66001****ESPOSITORE MINIBOX MAG-BIT+ (TM)****ESPOSITORE DA BANCO PER MINIBOX**
DISPLAY STAND FOR MINIBOX240
pcs.COD. **66001530****€ 749,000**

			L mm	COD.	box
10 pcs.		PH1	25	61355005010	2
10 pcs.		PH2	25	61355010010	3
10 pcs.		PH3	25	61355015010	2
5 pcs.		PH2	50	61356010005	2
10 pcs.		PZ1	25	61365005010	2
10 pcs.		PZ2	25	61365010010	3
10 pcs.		PZ3	25	61365015010	2
5 pcs.		PZ2	50	61366010005	2
10 pcs.		TX20	25	61375015010	1
10 pcs.		TX25	25	61375020010	2
10 pcs.		TX30	25	61375030010	2
10 pcs.		TX40	25	61375035010	2
1 pc.		MYBIT 7		66002445	4
1 pc.		C		62015010001	3
1 pc.		E		62029005	3

370 X 545 X 220 mm

STRUTTURA IN FILO METALLICO DA BANCO ED APPENDIBILE ADATTA AD ACCOGLIERE
20 MISURE DIVERSE DI INSERTI CONFEZIONATI IN MINIBOX E DUE ARTICOLI ACCESSORI.
COUNTERTOP OR WALL-MOUNTED METAL WIRE STRUCTURE, SUITABLE FOR HOLDING BITS
IN 20 DIFFERENT SIZES, MINIBOX PACKED AND TWO ACCESSORIES.



INSERTI 1/4" TORSION CON ANELLO COLORATO 1/4" colored ring torsion bits

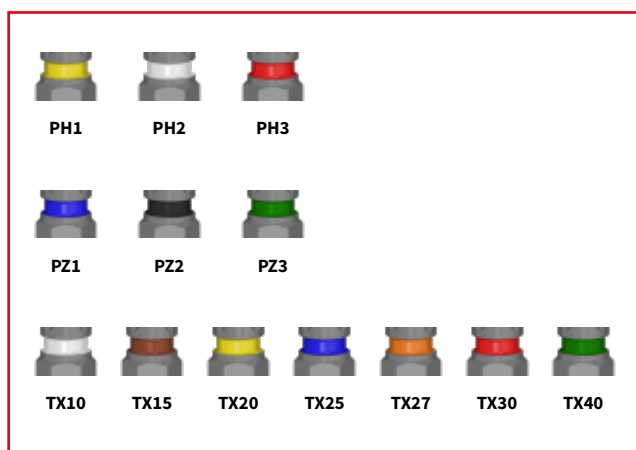

Incisione laser della misura
Laser marking of size

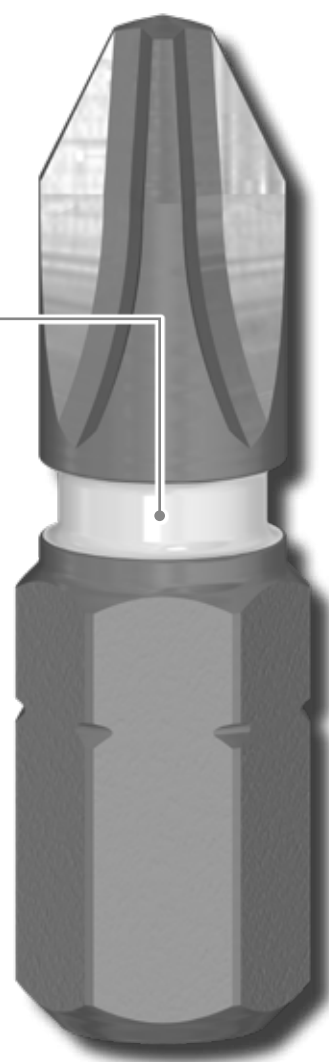

Applicazioni
applications

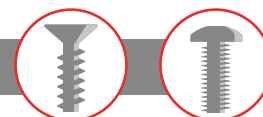

Collare verniciato resistente all'olio e ai solventi per sopportare qualsiasi condizione di lavoro.

Oil and solvents resistant painted ring to withstand any working condition.



L'esclusivo design permette di disperdere lo sforzo di torsione lungo tutto l'utensile.

The exclusive design allows distributing the torsional stress along the entire length of the tool.



Gamma completa delle misure più richieste e utilizzate sul mercato di due differenti lunghezze.

Full range of the most requested and used sizes on the market in two different lengths.

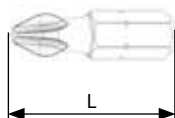
**61450 PH COLOUR+****INSERTI 1/4" C PHILLIPS® CON CODICE COLORE**
1/4" C PHILLIPS® BITS WITH COLOR CODE**58/60 HRC****EASYPACK** | sacchetto PVC con Euro-hole • PVC bags with Euro-hole

	L mm	PCS.	COD.	€ cad./each
PH1	25	10	61450005	0,986
PH2	25	10	61450010	0,986
PH3	25	10	61450015	0,986



	L mm	COD.	€ box
PH1	25	61450005002	3,473
PH2	25	61450010002	3,473
PH3	25	61450015002	3,473

SELFPACK
2 pcs.

	L mm	COD.	€ box
PH1	25	61450005010	10,355
PH2	25	61450010010	10,355
PH3	25	61450015010	10,355

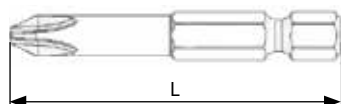
MINIBOX
10 pcs.**61451 PH COLOUR+****LAME 1/4" E PHILLIPS® CON CODICE COLORE**
1/4" E PHILLIPS® POWER BITS WITH COLOR CODE**58/60 HRC****EASYPACK** | sacchetto PVC con Euro-hole • PVC bags with Euro-hole

	L mm	PCS.	COD.	€ cad./each
PH1	50	5	61451005	2,050
PH2	50	5	61451010	2,050
PH3	50	5	61451015	2,050



	L mm	COD.	€ box
PH1	50	61451005002	5,655
PH2	50	61451010002	5,655
PH3	50	61451015002	5,655

SELFPACK
2 pcs.

	L mm	COD.	€ box
PH1	50	61451005005	10,763
PH2	50	61451010005	10,763
PH3	50	61451015005	10,763

MINIBOX
5 pcs.



1. LINEE PREMIUM

PREMIUM LINES

61460

PZ COLOUR+

INSERTI 1/4" C POZIDRIV® CON CODICE COLORE
1/4" C POZIDRIV® BITS WITH COLOR CODE

58/60 HRC

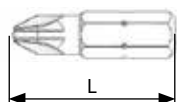

EASYPACK | sacchetto PVC con Euro-hole - PVC bags with Euro-hole

	L mm	PCS.	COD.	€ cad./each
PZ1	25	10	61460005	0,986
PZ2	25	10	61460010	0,986
PZ3	25	10	61460015	0,986



	L mm	COD.	€ box
PZ1	25	61460005002	3,473
PZ2	25	61460010002	3,473
PZ3	25	61460015002	3,473

SELFPACK
2 pcs.



	L mm	COD.	€ box
PZ1	25	61460005010	10,355
PZ2	25	61460010010	10,355
PZ3	25	61460015010	10,355

MINIBOX
10 pcs.

61461

PZ COLOUR+

LAME 1/4" E POZIDRIV® CON CODICE COLORE
1/4" E POZIDRIV® POWER BITS WITH COLOR CODE

58/60 HRC

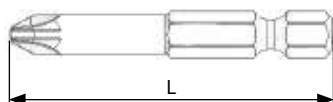

EASYPACK | sacchetto PVC con Euro-hole - PVC bags with Euro-hole

	L mm	PCS.	COD.	€ cad./each
PZ1	50	5	61461005	2,050
PZ2	50	5	61461010	2,050
PZ3	50	5	61461015	2,050



	L mm	COD.	€ box
PZ1	50	61461005002	5,655
PZ2	50	61461010002	5,655
PZ3	50	61461015002	5,655

SELFPACK
2 pcs.



	L mm	COD.	€ box
PZ1	50	61461005005	10,763
PZ2	50	61461010005	10,763
PZ3	50	61461015005	10,763

MINIBOX
5 pcs.



61470

TX COLOUR+

INSERTI 1/4" C PER VITI TORX® CON CODICE COLORE
1/4" C BITS FOR TORX® SCREWS WITH COLOR CODE

58/60 HRC

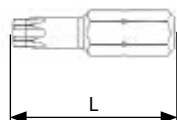

EASYPACK | sacchetto PVC con Euro-hole • PVC bags with Euro-hole

	L mm	PCS.	COD.	€ cad./each
TX10	25	10	61470005	1,221
TX15	25	10	61470010	1,221
TX20	25	10	61470015	1,221
TX25	25	10	61470020	1,221
TX27	25	10	61470025	1,221
TX30	25	10	61470030	1,221
TX40	25	10	61470035	1,221

	L mm	COD.	€ box
TX10	25	61470005002	3,941
TX15	25	61470010002	3,941
TX20	25	61470015002	3,941
TX25	25	61470020002	3,941
TX27	25	61470025002	3,941
TX30	25	61470030002	3,941
TX40	25	61470035002	3,941



SELPACK
2 pcs.



MINIBOX
10 pcs.

	L mm	COD.	€ box
TX10	25	61470005010	12,795
TX15	25	61470010010	12,795
TX20	25	61470015010	12,795
TX25	25	61470020010	12,795
TX27	25	61470025010	12,795
TX30	25	61470030010	12,795
TX40	25	61470035010	12,795

61471

TX COLOUR+

LAME 1/4" E PER VITI TORX® CON CODICE COLORE
1/4" E POWER BITS FOR TORX® SCREWS WITH COLOR CODE

58/60 HRC

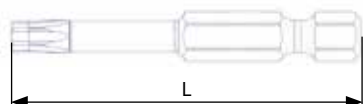

EASYPACK | sacchetto PVC con Euro-hole • PVC bags with Euro-hole

	L mm	PCS.	COD.	€ cad./each
TX10	50	5	61471005	3,730
TX15	50	5	61471010	3,730
TX20	50	5	61471015	3,730
TX25	50	5	61471020	3,730
TX27	50	5	61471025	3,730
TX30	50	5	61471030	3,730
TX40	50	5	61471035	3,730

	L mm	COD.	€ box
TX10	50	61471005002	8,893
TX15	50	61471010002	8,893
TX20	50	61471015002	8,893
TX25	50	61471020002	8,893
TX27	50	61471025002	8,893
TX30	50	61471030002	8,893
TX40	50	61471035002	8,893



SELPACK
2 pcs.



MINIBOX
5 pcs.

	L mm	COD.	€ box
TX10	50	61471005005	19,600
TX15	50	61471010005	19,600
TX20	50	61471015005	19,600
TX25	50	61471020005	19,600
TX27	50	61471025005	19,600
TX30	50	61471030005	19,600
TX40	50	61471035005	19,600



1. LINEE PREMIUM

PREMIUM LINES

66002

MYBIT 7 ASSORTIMENTI COLOUR+

ASSORTIMENTO 7 PCS. - INSERTI + PORTAINSERTI

7 PCS. SET - BITS + BIT HOLDER



7 pcs.



100 X 120 mm



INCLUSO
INCLUDED
COD. 62013005



COD. **66002430**

€ 13,922



PH1
1pc.

PH2
1pc.

PH3
1pc.

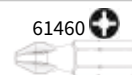

PZ1
1pc.

PZ2
1pc.

PZ3
1pc.

COD. **66002435**

€ 14,556



TX10
1pc.

TX15
1pc.

TX20
1pc.

TX25
1pc.

TX30
1pc.

TX40
1pc.

COD. **66002440**

€ 13,406

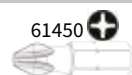

PH1
1pc.

PH2
1pc.

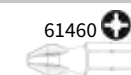

PZ1
1pc.

PZ2
1pc.

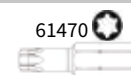

TX20
1pc.

TX25
1pc.

66002

DISPLAY MYBIT 7 COLOUR+

ESPOSITORE DA BANCO PER 12 BIT-SET

12 PCS. BIT-SET DISPLAY



12 pcs.

150 X 40 X 195 mm

COD. **66002434**

€ 159,466



12 pcs.
COD. 66002430

COD. **66002439**

€ 167,005



12 pcs.
COD. 66002435

COD. **66002444**

€ 153,216



12 pcs.
COD. 66002440



66007

MYBIT 7 POWER

ASSORTIMENTI COLOUR+

1.1

ASSORTIMENTO 7 PCS. - INSERTI
7 PCS. SET - BITS



7
pcs.

COD. **66007430**

€ 18,228

61451 L=50mm		61461 L=50mm		61471 L=50mm		
PH1	PH2	PZ1	PZ2	TX25	TX30	TX40
1pc.	1pc.	1pc.	1pc.	1pc.	1pc.	1pc.

COD. **66007435**

€ 13,642

61451 L=50mm			61461 L=50mm		
PH1	PH2	PH3	PZ1	PZ2	PZ3
1pc.	2pcs.	1pc.	1pc.	1pc.	1pc.



100 X 120 mm





1. LINEE PREMIUM PREMIUM LINES

66005

MYBIT 10 ASSORTIMENTI COLOUR+

ASSORTIMENTO 10 PCS. - INSERTI + PORTAINSERTI

10 PCS. SET - BITS + BIT HOLDER



10
pcs.



100 X 120 mm



COD. **66005430**

€ 17,166

61450			61460			61470		
PH1	PH2	PH3	PZ1	PZ2	PZ3	TX25	TX30	TX40
1pc.	1pc.	1pc.	1pc.	1pc.	1pc.	1pc.	1pc.	1pc.

COD. **66005435**

€ 17,166

61450		61460		61470	
PH2	PH3	PZ2	PZ3	TX30	TX40
2pcs.	1pc.	2pcs.	1pc.	1pc.	2pcs.

INCLUSO
INCLUDED
COD. 62013005



66005

DISPLAY MYBIT 10 COLOUR+

ESPOSITORE DA BANCO PER 12 BIT-SET

12 PCS. BIT-SET DISPLAY



12
pcs.

150 X 40 X 195 mm

COD. **66005434**

€ 197,192



12 pcs.
COD. 66005430

COD. **66005439**

€ 197,192



12 pcs.
COD. 66005435



66006

MYBIT 15 ASSORTIMENTI COLOUR+

ASSORTIMENTO 15 PCS. - INSERTI + PORTAINSERTI





15 PCS. SET - BITS + BIT-HOLDER



15 pcs.

COD. **66006030**

€ 23,345

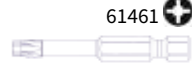
 61450			 61460		
PH1 1pc.	PH2 1pc.	PH3 1pc.	PZ1 1pc.	PZ2 1pc.	PZ3 1pc.
 61470			 61461		
TX15 1pc.	TX20 1pc.	TX25 1pc.	4,5x0,6 1pc.	5,0x0,8 1pc.	6,5x1,2 1pc.
 61451			 61461		
PH2 1pc.			PZ2 1pc.		



100 X 167 mm



INCLUSO
INCLUDED
COD. 62013005



66006

DISPLAY MYBIT 15 COLOUR+

ESPOSITORE DA BANCO PER 12 BIT-SET

12 PCS. BIT-SET DISPLAY



12 pcs.

COD. **66006034**

€ 259,840



12 pcs.
COD. 66006030

185 X 40 X 195 mm



1. LINEE PREMIUM PREMIUM LINES

66006

MYBIT 14 COLOUR+ CON CRICCHETTO

ASSORTIMENTO 14 PCS. COLOUR+ / CRICCHETTO
14 PCS. SET - BITS + BIT HOLDER AND RATCHET

COD. **66006530**

€ 38,254

14
pcs.



61450			61460		
PH1	PH2	PH3	PZ1	PZ2	PZ3
1pc.	1pc.	1pc.	1pc.	1pc.	1pc.
61470					
TX10	TX15	TX20	TX25	TX30	TX40
1pc.	1pc.	1pc.	1pc.	1pc.	1pc.



100 X 170 mm



INCLUSO / INCLUDED

COD. 62013005



COD. 64221030





66001

STORE 9 ASSORTIMENTI COLOUR+

CASSETTIERA CON 9 SCOMPARTI PER ESPOSITORE MULTISTORE
DRAWER WITH 9 COMPARTMENTS FOR MULTISTORE DISPLAY

200
pcs.



600 X 90 X 65 mm

COD. **66001085**
€ **186,278**

61450			61460			61470		
PH1	PH2	PH3	PZ1	PZ2	PZ3	TX20	TX25	TX30
20pcs.	30pcs.	20pcs.	20pcs.	30pcs.	20pcs.	20pcs.	20pcs.	20pcs.



MULTI STORE

COD. 66001005VC

PER DETTAGLI E COMPOSIZIONE VEDERE P. 184
FOR DETAILS AND COMPOSITION SEE p.184



1. LINEE PREMIUM PREMIUM LINES

66001

MULTI **BIT** ESPOSITORE INSERTI COLOUR+

ESPOSITORE DA BANCO CON 25 SCOMPARTI
DISPLAY WITH 25 COMPARTMENTS

290
pcs.



445 X 465 X 210 mm

STRUTTURA IN POLIPROPILENE ALVEOLARE AUTOPORTANTE, 25 SCOMPARTI.
SELF-SUPPORTING POLYPROPYLENE HONEYCOMB STRUCTURE, 25 COMPARTMENTS.

COD. **66001345**

€ 509,443

61450



PH1 10pcs.	PH2 20pcs.	PH3 10pcs.
---------------	---------------	---------------

61460



PZ1 10pcs.	PZ2 20pcs.	PZ3 10pcs.
---------------	---------------	---------------

61470



TX10 10pcs.	TX15 10pcs.	TX20 10pcs.	TX25 20pcs.	TX30 20pcs.	TX40 20pcs.
----------------	----------------	----------------	----------------	----------------	----------------

61451



PH1 10pcs.	PH2 10pcs.	PH3 10pcs.
---------------	---------------	---------------

61461



PZ1 10pcs.	PZ2 10pcs.	PZ3 10pcs.
---------------	---------------	---------------

61471



TX10 5pcs.	TX15 5pcs.	TX20 10pcs.	TX25 10pcs.	TX30 10pcs.	TX40 10pcs.
---------------	---------------	----------------	----------------	----------------	----------------

62013005



10pcs.

**66001****MULTI BOX ESPOSITORE MINIBOX COLOUR+****ESPOSITORE DA BANCO PER MINIBOX**
DISPLAY STAND FOR MINIBOX240
pcs.COD. **66001535****€ 403,903**

			L mm	COD.	box
10 pcs.		PH1	25	61450005010	2
10 pcs.		PH2	25	61450010010	3
10 pcs.		PH3	25	61450015010	2
5 pcs.		PH2	50	61451010005	2
10 pcs.		PZ1	25	61460005010	2
10 pcs.		PZ2	25	61460010010	3
10 pcs.		PZ3	25	61460015010	2
5 pcs.		PZ2	50	61461010005	2
10 pcs.		TX20	25	61470015010	1
10 pcs.		TX25	25	61470020010	2
10 pcs.		TX30	25	61470030010	2
10 pcs.		TX40	25	61470035010	2
1 pc.		MYBIT 7		66002430	2
1 pc.		MYBIT 15		66006030	2
1 pc.		CE		62015005001	3
1 pc.				62029005	3

370 X 545 X 220 mm

STRUTTURA IN FILO METALLICO DA BANCO ED APPENDIBILE ADATTA AD ACCOGLIERE
20 MISURE DIVERSE DI INSERTI CONFEZIONATI IN MINIBOX E DUE ARTICOLI ACCESSORI.
COUNTERTOP OR WALL-MOUNTED METAL WIRE STRUCTURE, SUITABLE FOR HOLDING BITS
IN 20 DIFFERENT SIZES, MINIBOX PACKED AND TWO ACCESSORIES.



INSERTI 1/4" PER AVVITATORI A MASSA BATTENTE 1/4" bits for impact wrenches

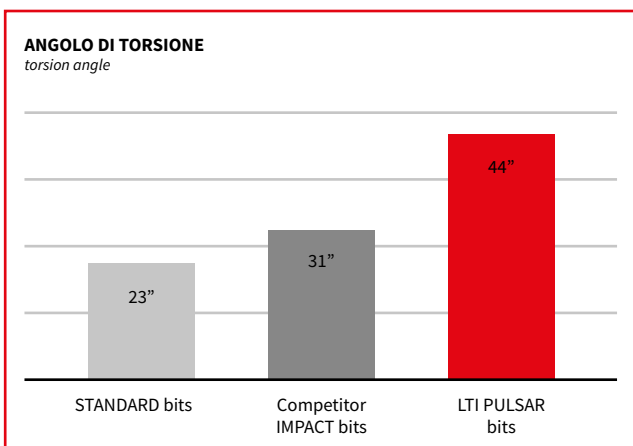
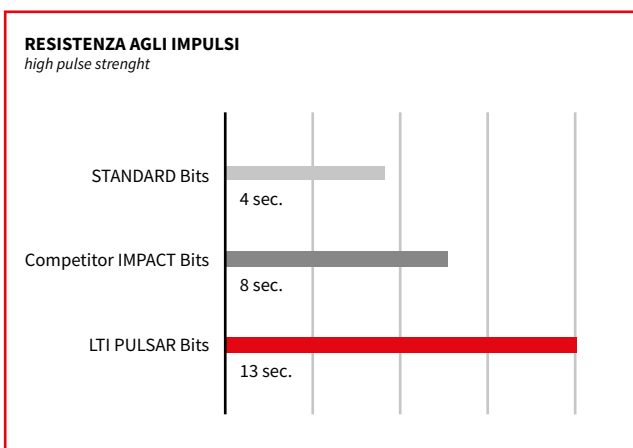

Applicazioni
applications

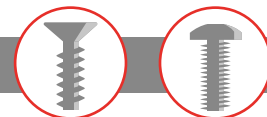

Progettati e testati per l'uso con avvitatori a massa battente.
Designed and tested for use with impact wrenches.



Alta resistenza agli impulsi, anche ad elevate velocità. Sopporta le sollecitazioni fino al 300% in più di un inserto tradizionale.
High pulse strength, even at high speeds. Withstands stress up to 300% higher than traditional bits.



Profilo ridotto per ottimizzare la resistenza agli sforzi di torsione, assorbe una deformazione doppia rispetto al normale.
Reduced profile to optimise resistance to twisting, withstands twice the deformation of normal bits.



61210

PH PULSAR®

INSERTI 1/4" C PHILLIPS® - PER AVVITATORI A MASSA BATTENTE 1/4" C PHILLIPS® BITS - FOR IMPACT WRENCHES

58/60 HRC

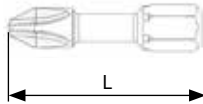

EASYPACK | sacchetto PVC con Euro-hole • PVC bags with Euro-hole

	L mm	PCS.	COD.	€ cad./each
PH1	30	10	61210005	2,072
PH2	30	10	61210010	2,072
PH3	30	10	61210015	2,072



	L mm	COD.	€ box
PH1	30	61210005002	5,645
PH2	30	61210010002	5,645
PH3	30	61210015002	5,645

SELPACK
2 pcs.



	L mm	COD.	€ box
PH1	30	61210005010	21,840
PH2	30	61210010010	21,840
PH3	30	61210015010	21,840

MINIBOX
10 pcs.

61211

PH PULSAR®

LAME 1/4" E PHILLIPS® - PER AVVITATORI A MASSA BATTENTE 1/4" E PHILLIPS® POWER BITS - FOR IMPACT WRENCHES

58/60 HRC



EASYPACK | sacchetto PVC con Euro-hole • PVC bags with Euro-hole

	L mm	PCS.	COD.	€ cad./each
PH1	50	5	61211005	3,640
PH2	50	5	61211010	3,640
PH3	50	5	61211015	3,640



	L mm	COD.	€ box
PH1	50	61211005002	8,758
PH2	50	61211010002	8,758
PH3	50	61211015002	8,758

SELPACK
2 pcs.



	L mm	COD.	€ box
PH1	50	61211005005	19,152
PH2	50	61211010005	19,152
PH3	50	61211015005	19,152

MINIBOX
5 pcs.



1. LINEE PREMIUM

PREMIUM LINES

61220

PZ PULSAR®

INSERTI 1/4" C POZIDRIV® - PER AVVITATORI A MASSA BATTENTE
1/4" C POZIDRIV® BITS - FOR IMPACT WRENCHES

58/60 HRC

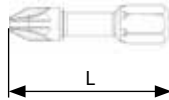

EASYPACK | sacchetto PVC con Euro-hole • PVC bags with Euro-hole

	L mm	PCS.	COD.	€ cad./each
PZ1	30	10	61220005	2,072
PZ2	30	10	61220010	2,072
PZ3	30	10	61220015	2,072



SELPACK
2 pcs.

	L mm	COD.	€ box
PZ1	30	61220005002	5,645
PZ2	30	61220010002	5,645
PZ3	30	61220015002	5,645



MINIBOX
10 pcs.

	L mm	COD.	€ box
PZ1	30	61220005010	21,840
PZ2	30	61220010010	21,840
PZ3	30	61220015010	21,840

61221

PZ PULSAR®

LAME 1/4" E POZIDRIV® - PER AVVITATORI A MASSA BATTENTE
1/4" E POZIDRIV® BITS - FOR IMPACT WRENCHES

58/60 HRC

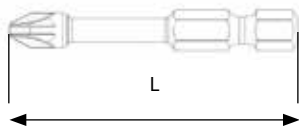

EASYPACK | sacchetto PVC con Euro-hole • PVC bags with Euro-hole

	L mm	PCS.	COD.	€ cad./each
PZ1	50	5	61221005	3,640
PZ2	50	5	61221010	3,640
PZ3	50	5	61221015	3,640



SELPACK
2 pcs.

	L mm	COD.	€ box
PZ1	50	61221005002	8,758
PZ2	50	61221010002	8,758
PZ3	50	61221015002	8,758



MINIBOX
5 pcs.

	L mm	COD.	€ box
PZ1	50	61221005005	19,152
PZ2	50	61221010005	19,152
PZ3	50	61221015005	19,152



61230

TX PULSAR®

INSERTI 1/4" C PER VITI TORX® - PER AVVITATORI A MASSA BATTENTE
1/4" C BITS FOR TORX® SCREWS - FOR IMPACT WRENCHES

58/60 HRC

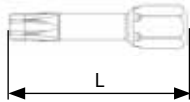

EASYPACK | sacchetto PVC con Euro-hole • PVC bags with Euro-hole

	L mm	PCS.	COD.	€ cad./each
TX10	30	10	61230003	2,610
TX15	30	10	61230004	2,610
TX20	30	10	61230005	2,610
TX25	30	10	61230010	2,610
TX27	30	10	61230013	2,610
TX30	30	10	61230015	2,610
TX40	30	10	61230020	2,610

	L mm	COD.	€ box
TX10	30	61230003002	6,720
TX15	30	61230004002	6,720
TX20	30	61230005002	6,720
TX25	30	61230010002	6,720
TX27	30	61230013002	6,720
TX30	30	61230015002	6,720
TX40	30	61230020002	6,720

	L mm	COD.	€ box
TX10	30	61230003010	27,328
TX15	30	61230004010	27,328
TX20	30	61230005010	27,328
TX25	30	61230010010	27,328
TX27	30	61230013010	27,328
TX30	30	61230015010	27,328
TX40	30	61230020010	27,328



SELFPACK
2 pcs.



MINIBOX
10 pcs.

61231

TX PULSAR®

LAME 1/4" E PER VITI TORX® - PER AVVITATORI A MASSA BATTENTE
1/4" E POWER BITS FOR TORX® SCREWS - FOR IMPACT WRENCHES

58/60 HRC

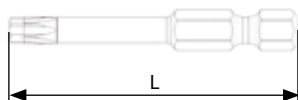

EASYPACK | sacchetto PVC con Euro-hole • PVC bags with Euro-hole

	L mm	PCS.	COD.	€ cad./each
TX10	50	5	61231003	4,265
TX15	50	5	61231004	4,265
TX20	50	5	61231005	4,265
TX25	50	5	61231010	4,265
TX27	50	5	61231013	4,265
TX30	50	5	61231015	4,265
TX40	50	5	61231020	4,265

	L mm	COD.	€ box
TX10	50	61231003002	10,094
TX15	50	61231004002	10,094
TX20	50	61231005002	10,094
TX25	50	61231010002	10,094
TX27	50	61231013002	10,094
TX30	50	61231015002	10,094
TX40	50	61231020002	10,094

	L mm	COD.	€ box
TX10	50	61231003005	22,372
TX15	50	61231004005	22,372
TX20	50	61231005005	22,372
TX25	50	61231010005	22,372
TX27	50	61231013005	22,372
TX30	50	61231015005	22,372
TX40	50	61231020005	22,372



SELFPACK
2 pcs.



MINIBOX
5 pcs.



1. LINEE PREMIUM

PREMIUM LINES

61200

HEX PULSAR®

INSERTI 1/4" C ESAGONALI - PER AVVITATORI A MASSA BATTENTE
1/4" C HEX BITS - FOR IMPACT WRENCHES

58/60 HRC

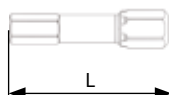

EASYPACK | sacchetto PVC con Euro-hole • PVC bags with Euro-hole

Ø	L mm	PCS.	COD.	€ cad./each
4	30	10	61200005	2,979
5	30	10	61200010	2,979
6	30	10	61200015	2,979



SELPACK
2 pcs.

Ø	L mm	COD.	€ box
4	30	61200005002	7,448
5	30	61200010002	7,448
6	30	61200015002	7,448



MINIBOX
10 pcs.

Ø	L mm	COD.	€ box
4	30	61200005010	31,248
5	30	61200010010	31,248
6	30	61200015010	31,248

61201

HEX PULSAR®

LAME 1/4" E ESAGONALI - PER AVVITATORI A MASSA BATTENTE
1/4" E HEX BITS - FOR IMPACT WRENCHES

58/60 HRC



EASYPACK | sacchetto PVC con Euro-hole • PVC bags with Euro-hole

Ø	L mm	PCS.	COD.	€ cad./each
4	50	5	61201005	5,376
5	50	5	61201010	5,376
6	50	5	61201015	5,376



SELPACK
2 pcs.

Ø	L mm	COD.	€ box
4	50	61201005002	12,320
5	50	61201010002	12,320
6	50	61201015002	12,320



MINIBOX
5 pcs.

Ø	L mm	COD.	€ box
4	50	61201005005	28,224
5	50	61201010005	28,224
6	50	61201015005	28,224

**62035****PORTAINSERTI PULSAR®****1.1****PORTAINSERTI MAGNETICO ANTI-SHOCK PER AVVITATORI A MASSA BATTENTE**
MAGNETIC BIT-HOLDER ANTI-SHOCK FOR IMPACT WRENCHES

EASYPACK | sacchetto PVC con Euro-hole - PVC bags with Euro-hole

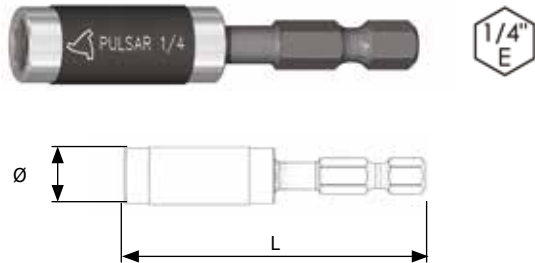

L mm	Ø mm	PCS.	COD.	€ cad./each
60	11	5	62035005	11,765

PRESTAZIONI INSERTO + PORTAINSERTO

Bit + bit-holder performances / prestations de l'embout + porte-embout / prestaciones punta + portapunta

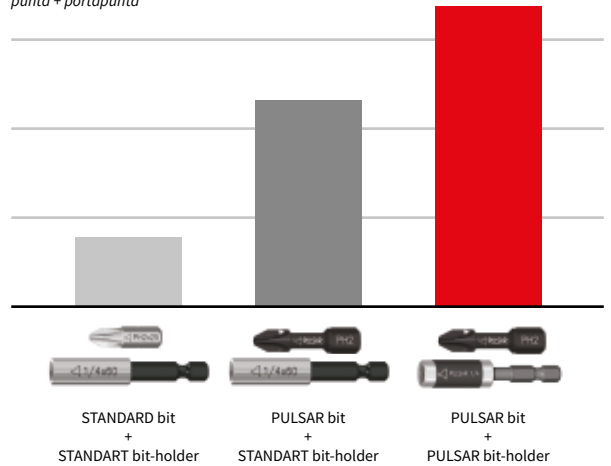
SELFPACK
1 pc.

L mm	COD.	€ box
60	62035005001	13,415

**FOCUS ON**

- ① Corpo rinforzato
 - ② Sistema antishock per la salvaguardia del magnete
 - ③ Guaina di protezione del corpo
 - ④ Esagono ribassato che aumenta l'angolo di coppia preservando l'inserto dalla deformazione
- ① Reinforced body
 - ② Antishock system to protect the magnet
 - ③ Protection sheath for the body
 - ④ Low-rise hexagon that increases the torque angle, protecting the insert from deformation

Appositamente studiato per lavorare con gli inserti della gamma LTI PULSAR: le esclusive geometrie costruttive fanno sì che gli inserti lavorino al meglio, garantendo una durata e prestazioni straordinarie.

Designed specifically to work with the range of LTI PULSAR bits: the exclusive construction geometries optimise the work of the bits, guaranteeing durability and outstanding performances.



1. LINEE PREMIUM PREMIUM LINES

66002

MYBIT 7 ASSORTIMENTI PULSAR®

ASSORTIMENTO 7 PCS. - INSERTI + PORTAINSERTI
7 PCS. SET - BITS + BIT-HOLDER



7 pcs.



100 X 120 mm



INCLUSO
INCLUDED
COD. 62035005



COD. **66002200**

€ 26,107

61210



PH2
1pc.

61220



PH3
1pc.

61230



PZ2
1pc.

61230



PZ3
1pc.

TX30
1pc.

TX40
1pc.

COD. **66002225**

€ 26,813

61210



PH2
1pc.

61220



PZ2
1pc.

61230



TX20
1pc.

TX25
1pc.

TX30
1pc.

TX40
1pc.

COD. **66002215**

€ 24,931

61210



PH1
1pc.

PH2
1pc.

PH3
1pc.

PZ1
1pc.

PZ2
1pc.

PZ3
1pc.

66002

DISPLAY MYBIT 7 PULSAR®

ESPOSITORE DA BANCO PER 12 BIT-SETS
12 PCS. BIT-SET DISPLAY



12 pcs.

150 X 40 X 195 mm

COD. **66002204**

€ 298,368



12 pcs.
COD. 66002200

COD. **66002229**

€ 306,432



12 pcs.
COD. 66002225

COD. **66002219**

€ 284,928



12 pcs.
COD. 66002215



66007

MYBIT 7 POWER ASSORTIMENTI PULSAR®

ASSORTIMENTO 7 PCS. - INSERTI
7 PCS. SET - BITS



7
pcs.

COD. **66007200**
€ 26,404

61211 L=50mm		61221 L=50mm		61231 L=50mm		
PH1	PH2	PZ1	PZ2	TX25	TX30	TX40
1pc.	1pc.	1pc.	1pc.	1pc.	1pc.	1pc.

COD. **66007205**
€ 24,333

61211 L=50mm			61221 L=50mm		
PH1	PH2	PH3	PZ1	PZ2	PZ3
1pc.	2pcs.	1pc.	1pc.	1pc.	1pc.



100 X 120 mm





1. LINEE PREMIUM PREMIUM LINES

66005

MYBIT10 ASSORTIMENTI PULSAR®

ASSORTIMENTO 10 PCS. - INSERTI + PORTAINSERTI
10 PCS. SET - BITS + BIT-HOLDER



10
pcs.



100 X 120 mm



INCLUSO
INCLUDED

COD. 62035005



COD. **66005200**

€ 31,170

61210		61220		61230		61200	
PH2	PH3	PZ2	PZ3	TX30	TX40	E5	E6
2pcs.	1pc.	1pc.	1pc.	1pc.	1pc.	1pc.	1pc.

COD. **66005205**

€ 30,984

61210		61220		61230			
PH2		PZ2		TX20	TX25	TX30	TX40
2pcs.		2pcs.		1pc.	1pc.	2pcs.	1pc.

COD. **66005210**

€ 32,771

61230							
TX20		TX25		TX30		TX40	
2pcs.		2pcs.		3pcs.		2pcs.	

COD. **66005215**

€ 29,814

61210			61220		61230			
PH1	PH2	PH3	PZ2	PZ3	TX20	TX25	TX30	TX40
1pc.	1pc.	1pc.	1pc.	1pc.	1pc.	1pc.	1pc.	1pc.



66005

DISPLAY MYBIT 10 PULSAR®

ESPOSITORE DA BANCO PER 12 BIT-SETS
12 PCS. BIT-SET DISPLAY

1.1



12 pcs.

150 X 40 X 195 mm

COD. **66005204**
€ 357,773



12 pcs.
COD. 66005200

COD. **66005209**
€ 355,206



12 pcs.
COD. 66005205

COD. **66005214**
€ 375,379



12 pcs.
COD. 66005210

COD. **66005219**
€ 341,510



12 pcs.
COD. 66005215



66001

STORE 9 ASSORTIMENTI PULSAR®

CASSETTIERA CON 9 SCOMPARTI PER ESPOSITORE MULTISTORE
DRAWERS WITH 9 COMPARTMENTS FOR MULTISTORE DISPLAY



600 X 90 X 65 mm



MULTISTORE

COD. 66001005VC

PER DETTAGLI E COMPOSIZIONE VEDERE P. 184
 FOR DETAILS AND COMPOSITION SEE p.184

110
pcs.

COD. **66001055**

€ 216,966

61210			61220			61230		
PH1	PH2	PH3	PZ1	PZ2	PZ3	TX25	TX30	TX40
10pcs.	20pcs.	10pcs.	10pcs.	20pcs.	10pcs.	10pcs.	10pcs.	10pcs.

140
pcs.

COD. **66001056**

€ 311,808

61210		61220		61230		
PH2	PH3	PZ2	PZ3	TX25	TX30	TX40
20pcs.	10pcs.	20pcs.	10pcs.	20pcs.	20pcs.	20pcs.

61211	61221
PH2	PZ2
10pcs.	10pcs.



66001

MULTI **BIT** ESPOSITORE INSERTI PULSAR®

ESPOSITORE DA BANCO CON 25 SCOMPARTI
DISPLAY WITH 25 COMPARTMENTS

285
pcs.



















445 X 465 X 210 mm

STRUTTURA IN POLIPROPILENE ALVEOLARE AUTOPORTANTE, 25 SCOMPARTI.
SELF-SUPPORTING POLYPROPYLENE HONEYCOMB STRUCTURE, 25 COMPARTMENTS.

COD. **66001305**

€ 846,720

61210  			61220  						
PH1 10pcs.	PH2 20pcs.	PH3 10pcs.	PZ1 10pcs.	PZ2 20pcs.	PZ3 10pcs.				
61230  					61200  				
TX10 10pcs.	TX15 10pcs.	TX20 10pcs.	TX25 20pcs.	TX30 20pcs.	TX40 20pcs.	4 5pcs.	5 5pcs.	6 5pcs.	
61211  			61221  						
PH1 10pcs.	PH2 10pcs.	PH3 10pcs.	PZ1 10pcs.	PZ2 10pcs.	PZ3 10pcs.				
61231  					62035005   				
TX25 10pcs.	TX30 10pcs.	TX40 10pcs.	10pcs.						



66001

MULTIBOX ESPOSITORE MINIBOX PULSAR®

ESPOSITORE DA BANCO PER MINIBOX
DISPLAY STAND FOR MINIBOX



199
pcs.

COD. **66001505**

€ **644,700**

			L mm	COD.	box
10 pcs.		PH1	30	61210005010	1
10 pcs.		PH2	30	61210010010	3
10 pcs.		PH3	30	61210015010	1
5 pcs.		PH2	50	61211010005	2
10 pcs.		PZ1	30	61220005010	1
10 pcs.		PZ2	30	61220010010	3
10 pcs.		PZ3	30	61220015010	1
5 pcs.		PZ2	50	61221010005	2
10 pcs.		TX20	30	61230005010	1
10 pcs.		TX25	30	61230010010	2
10 pcs.		TX30	30	61230015010	2
10 pcs.		TX40	30	61230020010	2
1 pc.		MYBIT 7		66002200	2
1 pc.		MYBIT 10		66005200	2
1 pc.		C		62035005001	3
1 pc.		C		62025005001	2

370 X 545 X 220 mm

STRUTTURA IN FILO METALLICO DA BANCO ED APPENDIBILE ADATTA AD ACCOGLIERE
20 MISURE DIVERSE DI INSERTI CONFEZIONATI IN MINIBOX E DUE ARTICOLI ACCESSORI.
COUNTERTOP OR WALL-MOUNTED METAL WIRE STRUCTURE, SUITABLE FOR HOLDING BITS
IN 20 DIFFERENT SIZES, MINIBOX PACKED AND TWO ACCESSORIES.



FOCUS ON

1.1

AVVITATORI IDRAULICI O AD IMPULSI

Hanno una forza di serraggio elevata ottenuta attraverso rapidissimi incrementi della pressione dell'olio. A fine serraggio viene prodotta una coppia intermittente e la tensione assiale si stabilizza. La coppia massima può essere regolata tramite la taratura della pressione dell'olio (fig. 1).

HYDRAULIC OR PULSE WRENCHES

They have a high clamping force obtained through very rapid increases in oil pressure. An intermittent torque is produced at the end of clamping and the axial tension stabilises. The maximum torque can be adjusted by setting the oil pressure (fig. 1).



Diagramma della coppia di serraggio in un avvitatore idraulico ad impulsi.

Diagram of the tightening torque in a hydraulic pulse wrench.

AVVITATORI A MASSA BATTENTE

Sviluppano un'elevatissima forza di serraggio ottenuta mediante l'impatto di due parti metalliche, chiamate incudine e martello. A differenza degli avvitatori ad impulsi, la tensione assiale continua a crescere in funzione del tempo (fig 2).

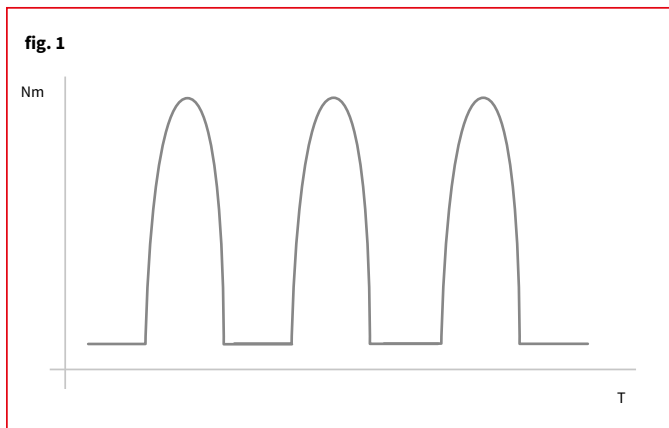
IMPACT WRENCHES

They develop a very high clamping force obtained through the impact of two metallic parts, called the anvil and hammer. Unlike pulse wrenches, the axial tension continues to grow over time (fig. 2).



Diagramma della coppia di serraggio in un avvitatore a massa battente.

Diagram of the tightening torque in an impact wrench.

LTI®



INSERTI 1/4" TENACI RESISTENTI A COPPIE ELEVATE
 1/4" heavy duty bits, high torques resistant



ANGOLO DI TORSIONE torsion angle

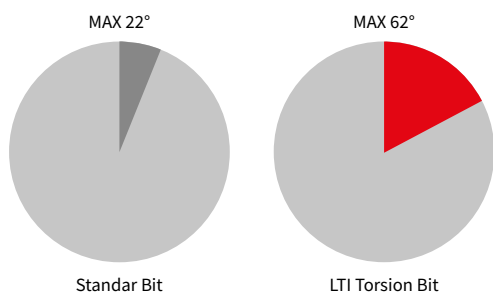

ASSORBIMENTO COPPIA DI TORSIONE

Torque absorption / absorption du couple de torsion / absorción de la par de torsión

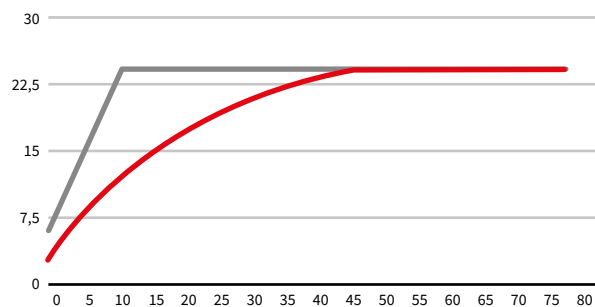

Applicazioni
 applications

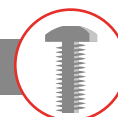

L'esclusivo design permette di disperdere lo sforzo di torsione lungo tutto l'utensile.

The exclusive design allows distributing the torsional stress along the entire length of the tool.



Qualità tenace, indicata per assorbire i picchi di coppia negli avvvitamenti su materiali duri.

Tough grade, suitable for absorbing torque peaks when screwing into hard materials.



Minimizzando i picchi si riduce l'usura, massimizzando la vita dell'utensile.

Minimisation of peaks reduces wear and maximises tool life.

**61058****PH TORSION®**

INSERTI 1/4" C PHILLIPS® - TENACI RESISTENTI A COPPIE ELEVATE
1/4" C PHILLIPS® BITS - HEAVY DUTY, RESISTANT TO HIGH TORQUES

58/60 HRC

EASYPACK | sacchetto PVC con Euro-hole - PVC bags with Euro-hole

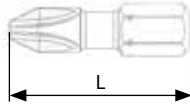

	L mm	PCS.	COD.	€ cad./each
PH1	25	10	61058005	1,058
PH2	25	10	61058010	1,058
PH3	25	10	61058015	1,058

SELFPACK
2 pcs.

	L mm	COD.	€ box
PH1	25	61058005002	3,611
PH2	25	61058010002	3,611
PH3	25	61058015002	3,611

MINIBOX
10 pcs.

	L mm	COD.	€ box
PH1	25	61058005010	11,173
PH2	25	61058010010	11,173
PH3	25	61058015010	11,173

61059**PH TORSION®**

LAME 1/4" E PHILLIPS® - TENACI RESISTENTI A COPPIE ELEVATE
1/4" E PHILLIPS® POWER BITS - HEAVY DUTY, RESISTANT TO HIGH TORQUES

58/60 HRC

EASYPACK | sacchetto PVC con Euro-hole - PVC bags with Euro-hole

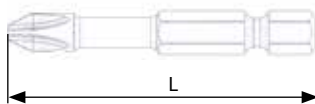

	L mm	PCS.	COD.	€ cad./each
PH1	50	5	61059005	2,842
PH2	50	5	61059010	2,842
PH3	50	5	61059015	2,842

SELFPACK
2 pcs.

	L mm	COD.	€ box
PH1	50	61059005002	7,182
PH2	50	61059010002	7,182
PH3	50	61059015002	7,182

MINIBOX
5 pcs.

	L mm	COD.	€ box
PH1	50	61059005005	14,918
PH2	50	61059010005	14,918
PH3	50	61059015005	14,918



1. LINEE PREMIUM

PREMIUM LINES

61083

PZ TORSION®

INSERTI 1/4" C POZIDRIV® - TENACI RESISTENTI A COPPIE ELEVATE
1/4" C POZIDRIV® BITS - HEAVY DUTY, RESISTANT TO HIGH TORQUES

58/60 HRC



EASYPACK | sacchetto PVC con Euro-hole • PVC bags with Euro-hole

	L mm	PCS.	COD.	€ cad./each
PZ1	25	10	61083005	1,058
PZ2	25	10	61083010	1,058
PZ3	25	10	61083015	1,058



SELPACK
2 pcs.

	L mm	COD.	€ box
PZ1	25	61083005002	3,611
PZ2	25	61083010002	3,611
PZ3	25	61083015002	3,611



MINIBOX
10 pcs.

	L mm	COD.	€ box
PZ1	25	61083005010	11,173
PZ2	25	61083010010	11,173
PZ3	25	61083015010	11,173

61084

PZ TORSION®

LAME 1/4" E POZIDRIV® - TENACI RESISTENTI A COPPIE ELEVATE
1/4" E POZIDRIV® POWER BITS - HEAVY DUTY, RESISTANT TO HIGH TORQUES

58/60 HRC



EASYPACK | sacchetto PVC con Euro-hole • PVC bags with Euro-hole

	L mm	PCS.	COD.	€ cad./each
PZ1	50	5	61084005	2,842
PZ2	50	5	61084010	2,842
PZ3	50	5	61084015	2,842



SELPACK
2 pcs.

	L mm	COD.	€ box
PZ1	50	61084005002	7,182
PZ2	50	61084010002	7,182
PZ3	50	61084015002	7,182



MINIBOX
5 pcs.

	L mm	COD.	€ box
PZ1	50	61084005005	14,918
PZ2	50	61084010005	14,918
PZ3	50	61084015005	14,918

**61103****TX TORSION®**

INSERTI 1/4" C PER VITI TORX® - TENACI RESISTENTI A COPPIE ELEVATE
1/4" C BITS FOR TORX® SCREWS - HEAVY DUTY, RESISTANT TO HIGH TORQUES

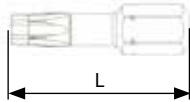
58/60 HRC

EASYPACK | sacchetto PVC con Euro-hole • PVC bags with Euro-hole

	L mm	PCS.	COD.	€ cad./each
TX10	25	10	61103005	1,299
TX15	25	10	61103010	1,299
TX20	25	10	61103015	1,299
TX25	25	10	61103020	1,299
TX27	25	10	61103025	1,299
TX30	25	10	61103030	1,299
TX40	25	10	61103035	1,299

	L mm	COD.	€ box
TX10	25	61103005002	4,088
TX15	25	61103010002	4,088
TX20	25	61103015002	4,088
TX25	25	61103020002	4,088
TX27	25	61103025002	4,088
TX30	25	61103030002	4,088
TX40	25	61103035002	4,088

SELFPACK
2 pcs.MINIBOX
10 pcs.

	L mm	COD.	€ box
TX10	25	61103005010	13,552
TX15	25	61103010010	13,552
TX20	25	61103015010	13,552
TX25	25	61103020010	13,552
TX27	25	61103025010	13,552
TX30	25	61103030010	13,552
TX40	25	61103035010	13,552

61104**TX TORSION®**

LAME 1/4" E PER VITI TORX® - TENACI RESISTENTI A COPPIE ELEVATE
1/4" E POWER BITS FOR TORX® SCREWS - HEAVY DUTY, RESISTANT TO HIGH TORQUES

58/60 HRC

EASYPACK | sacchetto PVC con Euro-hole • PVC bags with Euro-hole

	L mm	PCS.	COD.	€ cad./each
TX10	50	5	61104005	4,163
TX15	50	5	61104010	4,163
TX20	50	5	61104015	4,163
TX25	50	5	61104020	4,163
TX27	50	5	61104025	4,163
TX30	50	5	61104030	4,163
TX40	50	5	61104035	4,163

	L mm	COD.	€ box
TX10	50	61104005002	9,882
TX15	50	61104010002	9,882
TX20	50	61104015002	9,882
TX25	50	61104020002	9,882
TX27	50	61104025002	9,882
TX30	50	61104030002	9,882
TX40	50	61104035002	9,882

SELFPACK
2 pcs.MINIBOX
5 pcs.

	L mm	COD.	€ box
TX10	50	61104005005	21,865
TX15	50	61104010005	21,865
TX20	50	61104015005	21,865
TX25	50	61104020005	21,865
TX27	50	61104025005	21,865
TX30	50	61104030005	21,865
TX40	50	61104035005	21,865



1. LINEE PREMIUM PREMIUM LINES

66002

MYBIT 7 ASSORTIMENTI TORSION®

ASSORTIMENTO 7 PCS. - INSERTI + PORTAINSERTI
7 PCS. SET - BITS + BIT-HOLDER



7
pcs.



100 X 120 mm



INCLUSO
INCLUDED

COD. 62013005



COD. **66002300**

€ 14,168

61058



PH1
1pc.

PH2
1pc.

PH3
1pc.

61083



PZ1
1pc.

PZ2
1pc.

PZ3
1pc.

COD. **66002305**

€ 15,053

61103



TX10
1pc.

TX15
1pc.

TX20
1pc.

TX25
1pc.

TX30
1pc.

TX40
1pc.

COD. **66002310**

€ 14,031

61058



PH2
1pc.

PH3
1pc.

61083



PZ2
1pc.

PZ3
1pc.

61103



TX25
1pc.

TX30
1pc.

66002

DISPLAY MYBIT 7 TORSION®

ESPOSITORE DA BANCO PER 12 BIT-SETS
12 PCS. BIT-SET DISPLAY



12
pcs.

150 X 40 X 195 mm

COD. **66002304**

€ 162,288



12 pcs.
COD. 66002300

COD. **66002309**

€ 172,570



12 pcs.
COD. 66002305

COD. **66002314**

€ 160,581



12 pcs.
COD. 66002310



66007

MYBIT 7 POWER ASSORTIMENTI TORSION®











1.1

ASSORTIMENTO 7 PCS. - INSERTI
7 PCS. SET - BITS











7
pcs.

COD. **66007300**
€ 22,926

61059  L=50mm		61084  L=50mm		61104  L=50mm		
						
PH1 1pc.	PH2 1pc.	PZ1 1pc.	PZ2 1pc.	TX25 1pc.	TX30 1pc.	TX40 1pc.

COD. **66007305**
€ 20,608

61059  L=50mm			61084  L=50mm		
					
PH1 1pc.	PH2 2pcs.	PH3 1pc.	PZ1 1pc.	PZ2 1pc.	PZ3 1pc.



100 X 120 mm



1. LINEE PREMIUM PREMIUM LINES

66005

MYBIT 10 ASSORTIMENTI TORSION®

ASSORTIMENTO 10 PCS. - INSERTI + PORTAINSERI
10 PCS. SET - BITS + BIT-HOLDER



10
pcs.



100 X 120 mm



INCLUSO
INCLUDED



COD. 62013005

COD. **66005300**

€ 16,464

61058			61083			61103		
PH1	PH2	PH3	PZ1	PZ2	PZ3	TX20	TX25	TX30
1pc.	1pc.	1pc.	1pc.	1pc.	1pc.	1pc.	1pc.	1pc.

COD. **66005305**

€ 17,052

61058		61083		61103	
PH2	PH3	PZ2	PZ3	TX25	TX30
2pcs.	1pc.	2pcs.	1pc.	1pc.	2pcs.

COD. **66005310**

€ 17,405

61058		61083		61103			
PH2	PH3	PZ2	PZ3	TX15	TX20	TX25	TX30
2pcs.	1pc.	1pc.	1pc.	1pc.	1pc.	1pc.	1pc.

66005

DISPLAY MYBIT 10 TORSION®

ESPOSITORE DA BANCO PER 12 BIT-SETS
12 PCS. BIT-SET DISPLAY



12
pcs.

150 X 40 X 195 mm

COD. **66005304**

€ 188,160



12 pcs.
COD. 66005300

COD. **66005309**

€ 194,880



12 pcs.
COD. 66005305

COD. **66005314**

€ 198,912



12 pcs.
COD. 66005310



66006

MYBIT¹⁵ ASSORTIMENTI TORSION®

ASSORTIMENTO 15 PCS. - INSERTI + PORTAINSERI
15 PCS. SET - BITS + BIT-HOLDER



15 pcs.

COD. **66006305**

€ 24,394

61058			61083		
PH1	PH2	PH3	PZ1	PZ2	PZ3
1pc.	1pc.	1pc.	1pc.	1pc.	1pc.
61103					
TX10	TX15	TX20	TX25	TX30	TX40
1pc.	1pc.	1pc.	1pc.	1pc.	1pc.
61059			61084		
PH2			PZ2		
1pc.			1pc.		



100 X 167 mm



INCLUSO
INCLUDED
COD. 62013005



66006

DISPLAY MYBIT¹⁵ TORSION®

ESPOSITORE DA BANCO PER 12 BIT-SETS
12 PCS. BIT-SET DISPLAY



12 pcs.

COD. **66006309**

€ 279,418

	12 pcs. COD. 66006305
--	--------------------------

185 X 40 X 195 mm



1. LINEE PREMIUM

PREMIUM LINES

66006

MYBIT/4 TORSION® CON CRICCHETTO

ASSORTIMENTO 14 PCS. TORSION® / CRICCHETTO
14 PCS. SET - BITS + BIT HOLDER AND RATCHET

14
pcs.



100 X 170 mm



COD. **66006505**

€ 39,026

61058			61069		
PH1 1pc.	PH2 1pc.	PH3 1pc.	PZ1 1pc.	PZ2 1pc.	PZ3 1pc.
61103					
TX10 1pc.	TX15 1pc.	TX20 1pc.	TX25 1pc.	TX30 1pc.	TX40 1pc.

INCLUSO
INCLUDED

COD. 62013005

COD. 64221030



66010

ASSORTIMENTI TORSION®

ASSORTIMENTO 31 PCS. - INSERTI + PORTAINSERITI
31 PCS. SET - BITS + BIT-HOLDER

31
pcs.



80 X 115 X 30 mm

COD. **66010030**

€ 40,807

61058			61083		
PH1 2pcs.	PH2 4pcs.	PH3 3pcs.	PZ1 2pcs.	PZ2 4pcs.	PZ3 3pcs.
61103					
TX20 3pcs.		TX25 3pcs.	TX30 3pcs.	TX40 3pcs.	

INCLUSO
INCLUDED

COD. 62013005





66001

STORE 9 ASSORTIMENTI TORSION®

CASSETTIERA CON 9 SCOMPARTI PER ESPOSITORE MULTISTORE
DRAWERS WITH 9 COMPARTMENTS FOR MULTISTORE DISPLAY

165
pcs.



600 X 90 X 65 mm



COD. **66001060**

€ **165,379**

61058			61083			61103		
PH1	PH2	PH3	PZ1	PZ2	PZ3	TX25	TX30	TX40
10pcs.	30pcs.	20pcs.	10pcs.	30pcs.	20pcs.	15pcs.	15pcs.	15pcs.

COD. **66001061**

€ **196,538**

61058		61083		61103		
PH1	PH2	PZ1	PZ2	TX25	TX30	TX40
20pcs.	30pcs.	20pcs.	30pcs.	15pcs.	15pcs.	15pcs.

61059		61084	
PH2		PZ2	
10pcs.		10pcs.	

MULTI STORE

COD. 66001005VC

PER DETTAGLI E COMPOSIZIONE VEDERE P. 184
FOR DETAILS AND COMPOSITION SEE p.184



1. LINEE PREMIUM

PREMIUM LINES

66001

MULTI**BIT** ESPOSITORE INSERTI TORSION[®]

ESPOSITORE DA BANCO CON 25 SCOMPARTI
DISPLAY WITH 25 COMPARTMENTS

310
pcs.



COD. **66001310**

€ **669,043**

61058



PH1 10pcs.	PH2 30pcs.	PH3 10pcs.
---------------	---------------	---------------

61083



PZ1 10pcs.	PZ2 20pcs.	PZ3 10pcs.
---------------	---------------	---------------

61103



TX10 10pcs.	TX15 10pcs.	TX20 10pcs.	TX25 20pcs.	TX30 20pcs.	TX40 20pcs.
----------------	----------------	----------------	----------------	----------------	----------------

61059



PH1 10pcs.	PH2 10pcs.	PH3 10pcs.
---------------	---------------	---------------

61084



PZ1 10pcs.	PZ2 10pcs.	PZ3 10pcs.
---------------	---------------	---------------

61104



TX10 10pcs.	TX15 10pcs.	TX20 10pcs.	TX25 10pcs.	TX30 10pcs.	TX40 10pcs.
----------------	----------------	----------------	----------------	----------------	----------------

62016005

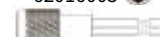

10pcs.

445 X 465 X 210 mm

STRUTTURA IN POLIPROPILENE ALVEOLARE AUTOPORTANTE, 25 SCOMPARTI.
 SELF-SUPPORTING POLYPROPYLENE HONEYCOMB STRUCTURE, 25 COMPARTMENTS.

**66001****MULTI BOX ESPOSITORE MINIBOX TORSION®****ESPOSITORE DA BANCO PER MINIBOX**
DISPLAY STAND FOR MINIBOX270
pcs.COD. **66001510****€ 542,082**

370 X 545 X 220 mm

STRUTTURA IN FILO METALLICO DA BANCO ED APPENDIBILE ADADTA AD ACCOGLIERE
20 MISURE DIVERSE DI INSERTI CONFEZIONATI IN MINIBOX E DUE ARTICOLI ACCESSORI.
COUNTERTOP OR WALL-MOUNTED METAL WIRE STRUCTURE, SUITABLE FOR HOLDING BITS
IN 20 DIFFERENT SIZES, MINIBOX PACKED AND TWO ACCESSORIES.

			L mm	COD.	box
10 pcs.		PH1	25	61058005010	2
10 pcs.		PH2	25	61058010010	3
10 pcs.		PH3	25	61058015010	2
5 pcs.		PH2	50	61059010005	2
10 pcs.		PZ1	25	61083005010	2
10 pcs.		PZ2	25	61083010010	3
10 pcs.		PZ3	25	61083015010	2
5 pcs.		PZ2	50	61084010005	2
10 pcs.		TX20	25	61103015010	2
10 pcs.		TX25	25	61103020010	2
10 pcs.		TX30	25	61103030010	3
10 pcs.		TX40	25	61103035010	3
1 pc.		MYBIT 7		66002300	2
1 pc.		MYBIT 14		66006505	2
1 pc.		C6		62019015001	3
1 pc.				62029005	3

TORSION+



INSERTI 1/4" RESISTENTI A COPPIE ELEVATE EXTRA HARD
1/4" extra-hard bits torques resistant



Applicazioni
applications

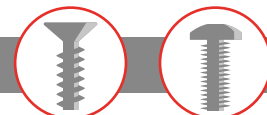

RAPPORTO DUREZZA-TENACITÀ Hardness-toughness ratio

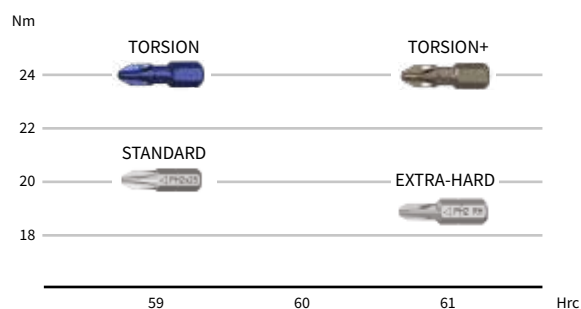

RESISTENZA ALL'USURA Wear resistance

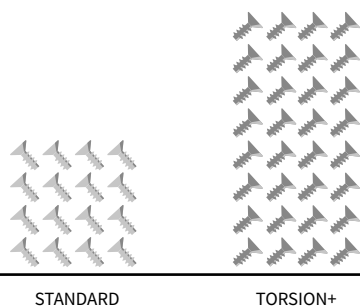

Perfetto rapporto durezza/tenacità, TORSION+ raggiunge elevatissimi valori di resistenza alla torsione.

Perfect hardness/toughness ratio, TORSION+ reaches very high values of torsional stiffness.

Ottima resistenza all'usura: la geometria dell'impronta rimane costante anche dopo moltissimi cicli di avvitatura.

Excellent wear resistance: the geometry of the tip remains constant even after numerous screwing cycles.

Ideali per applicazioni intensive, anche nel settore industriale, dove l'efficienza dell'utensile deve rimanere costante per lungo tempo.

Ideal for heavy-duty applications, even in the industrial sector where tool efficiency must remain constant over a long time.

**61250****PH TORSION+**

INSERTI 1/4" C PHILLIPS® - EXTRA DURI, RESISTENTI A COPPIE ELEVATE
1/4" C PHILLIPS® BITS - EXTRA HARD, RESISTANT TO HIGH TORQUES

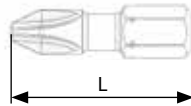
60/62 HRC

EASYPACK | sacchetto PVC con Euro-hole • PVC bags with Euro-hole

	L mm	PCS.	COD.	€ cad./each
PH1	25	10	61250005	1,330
PH2	25	10	61250010	1,330
PH3	25	10	61250015	1,330

SELFPACK
2 pcs.

	L mm	COD.	€ box
PH1	25	61250005002	4,161
PH2	25	61250010002	4,161
PH3	25	61250015002	4,161

MINIBOX
10 pcs.

	L mm	COD.	€ box
PH1	25	61250005010	13,910
PH2	25	61250010010	13,910
PH3	25	61250015010	13,910

61251**PH TORSION+**

LAME 1/4" E PHILLIPS® - EXTRA DURI, RESISTENTI A COPPIE ELEVATE
1/4" E PHILLIPS® POWER BITS - EXTRA HARD, RESISTANT TO HIGH TORQUES

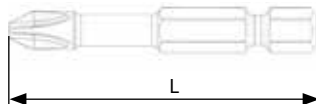
60/62 HRC

EASYPACK | sacchetto PVC con Euro-hole • PVC bags with Euro-hole

	L mm	PCS.	COD.	€ cad./each
PH1	50	5	61251005	3,084
PH2	50	5	61251010	3,084
PH3	50	5	61251015	3,084

SELFPACK
2 pcs.

	L mm	COD.	€ box
PH1	50	61251005002	7,676
PH2	50	61251010002	7,676
PH3	50	61251015002	7,676

MINIBOX
5 pcs.

	L mm	COD.	€ box
PH1	50	61251005005	16,229
PH2	50	61251010005	16,229
PH3	50	61251015005	16,229



1. LINEE PREMIUM

PREMIUM LINES

61260

PZ TORSION+

INSERTI 1/4" C POZIDRIV® - EXTRA DURI, RESISTENTI A COPPIE ELEVATE

1/4" C POZIDRIV® BITS - EXTRA HARD, RESISTANT TO HIGH TORQUES

60/62 HRC



EASYPACK | sacchetto PVC con Euro-hole • PVC bags with Euro-hole

	L mm	PCS.	COD.	€ cad./each
PZ1	25	10	61260005	1,330
PZ2	25	10	61260010	1,330
PZ3	25	10	61260015	1,330



SELFPACK
2 pcs.

	L mm	COD.	€ box
PZ1	25	61260005002	4,161
PZ2	25	61260010002	4,161
PZ3	25	61260015002	4,161



MINIBOX
10 pcs.

	L mm	COD.	€ box
PZ1	25	61260005010	13,910
PZ2	25	61260010010	13,910
PZ3	25	61260015010	13,910

61261

PZ TORSION+

LAME 1/4" E POZIDRIV® - EXTRA DURI, RESISTENTI A COPPIE ELEVATE

1/4" E POZIDRIV® POWER BITS - EXTRA HARD, RESISTANT TO HIGH TORQUES

60/62 HRC

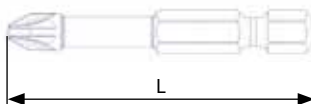

EASYPACK | sacchetto PVC con Euro-hole • PVC bags with Euro-hole

	L mm	PCS.	COD.	€ cad./each
PZ1	50	5	61261005	3,084
PZ2	50	5	61261010	3,084
PZ3	50	5	61261015	3,084



SELFPACK
2 pcs.

	L mm	COD.	€ box
PZ1	50	61261005002	7,676
PZ2	50	61261010002	7,676
PZ3	50	61261015002	7,676



MINIBOX
5 pcs.

	L mm	COD.	€ box
PZ1	50	61261005005	16,229
PZ2	50	61261010005	16,229
PZ3	50	61261015005	16,229

**61270****TX TORSION+**

INSERTI 1/4" C PER VITI TORX® - EXTRA DURI, RESISTENTI A COPPIE ELEVATE
1/4" C BITS FOR TORX® SCREWS - EXTRA HARD, RESISTANT TO HIGH TORQUES

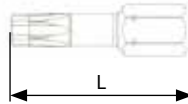
60/62 HRC

EASYPACK | sacchetto PVC con Euro-hole • PVC bags with Euro-hole

	L mm	PCS.	COD.	€ cad./each
TX10	25	10	61270005	1,593
TX15	25	10	61270010	1,593
TX20	25	10	61270015	1,593
TX25	25	10	61270020	1,593
TX27	25	10	61270025	1,593
TX30	25	10	61270030	1,593
TX40	25	10	61270035	1,593

	L mm	COD.	€ box
TX10	25	61270005002	4,687
TX15	25	61270010002	4,687
TX20	25	61270015002	4,687
TX25	25	61270020002	4,687
TX27	25	61270025002	4,687
TX30	25	61270030002	4,687
TX40	25	61270035002	4,687

SELPACK
2 pcs.MINIBOX
10 pcs.

	L mm	COD.	€ box
TX10	25	61270005010	16,733
TX15	25	61270010010	16,733
TX20	25	61270015010	16,733
TX25	25	61270020010	16,733
TX27	25	61270025010	16,733
TX30	25	61270030010	16,733
TX40	25	61270035010	16,733

61271**TX TORSION+**

LAME 1/4" E PER VITI TORX® - EXTRA DURI, RESISTENTI A COPPIE ELEVATE
1/4" E POWER BITS FOR TORX® SCREWS - EXTRA HARD, RESISTANT TO HIGH TORQUES

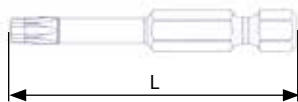
60/62 HRC

EASYPACK | sacchetto PVC con Euro-hole • PVC bags with Euro-hole

	L mm	PCS.	COD.	€ cad./each
TX10	50	5	61271005	4,486
TX15	50	5	61271010	4,486
TX20	50	5	61271015	4,486
TX25	50	5	61271020	4,486
TX27	50	5	61271025	4,486
TX30	50	5	61271030	4,486
TX40	50	5	61271035	4,486

	L mm	COD.	€ box
TX10	50	61271005002	10,498
TX15	50	61271010002	10,498
TX20	50	61271015002	10,498
TX25	50	61271020002	10,498
TX27	50	61271025002	10,498
TX30	50	61271030002	10,498
TX40	50	61271035002	10,498

SELPACK
2 pcs.MINIBOX
5 pcs.

	L mm	COD.	€ box
TX10	50	61271005005	23,587
TX15	50	61271010005	23,587
TX20	50	61271015005	23,587
TX25	50	61271020005	23,587
TX27	50	61271025005	23,587
TX30	50	61271030005	23,587
TX40	50	61271035005	23,587



1. LINEE PREMIUM PREMIUM LINES

66002

MYBIT 7 ASSORTIMENTI TORSION+

ASSORTIMENTO 7 PCS. - INSERTI + PORTAINSERTI
7 PCS. SET - BITS + BIT-HOLDER



7 pcs.



100 X 120 mm



COD. **66002350**

€ 15,340



PH1
1pc.



PH2
1pc.



PH3
1pc.



PZ1
1pc.



PZ2
1pc.



PZ3
1pc.

COD. **66002355**

€ 17,257



TX10
1pc.



TX15
1pc.



TX20
1pc.



TX25
1pc.



TX30
1pc.



TX40
1pc.

COD. **66002360**

€ 16,237



PH1
1pc.



PH2
1pc.



PZ1
1pc.



PZ2
1pc.



TX20
1pc.



TX25
1pc.

INCLUSO
INCLUDED
COD. 62013005



66002

DISPLAY MYBIT 7 TORSION+

ESPOSITORE DA BANCO PER 12 BIT-SETS
12 PCS. BIT-SET DISPLAY



12 pcs.

150 X 40 X 195 mm

COD. **66002354**

€ 175,473



12 pcs.
COD. 66002350

COD. **66002359**

€ 197,407



12 pcs.
COD. 66002355

COD. **66002364**

€ 185,902



12 pcs.
COD. 66002360



66007

MYBIT 7 POWER ASSORTIMENTI TORSION+











ASSORTIMENTO 7 PCS. - INSERTI
7 PCS. SET - BITS

1.1











7
pcs.

COD. **66007350**
€ 24,642

61251  L=50mm		61261  L=50mm		61271  L=50mm		
						
PH1 1pc.	PH2 1pc.	PZ1 1pc.	PZ2 1pc.	TX25 1pc.	TX30 1pc.	TX40 1pc.

COD. **66007355**
€ 22,509

61251  L=50mm			61261  L=50mm		
					
PH1 1pc.	PH2 2pcs.	PH3 1pc.	PZ1 1pc.	PZ2 1pc.	PZ3 1pc.



100 X 120 mm





1. LINEE PREMIUM PREMIUM LINES

66005

MYBIT 10 ASSORTIMENTI TORSION+

ASSORTIMENTO 10 PCS. - INSERTI + PORTAINSERI
10 PCS. SET - BITS + BIT-HOLDER



10
pcs.

COD. **66005350**

€ 20,227

61250			61260			61270		
PH1	PH2	PH3	PZ1	PZ2	PZ3	TX20	TX25	TX30
1pc.	1pc.	1pc.	1pc.	1pc.	1pc.	1pc.	1pc.	1pc.



100 X 120 mm



INCLUSO
INCLUDED
COD. 62013005



66005

DISPLAY MYBIT 10 TORSION+

ESPOSITORE DA BANCO PER 12 BIT-SETS
12 PCS. BIT-SET DISPLAY



12
pcs.

COD. **66005354**

€ 231,168



12 pcs.
COD. 66005350

150 X 40 X 195 mm



66006

MYBIT 15 ASSORTIMENTI TORSION+

ASSORTIMENTO 15 PCS. - INSERTI + PORTAINSERI
15 PCS. SET - BITS + BIT-HOLDER



15 pcs.

COD. **66006310**
€ 26,834



100 X 167 mm



INCLUSO
INCLUDED
COD. 62013005



61250			61260		
PH1 1pc.	PH2 1pc.	PH3 1pc.	PZ1 1pc.	PZ2 1pc.	PZ3 1pc.
61270					
TX10 1pc.	TX15 1pc.	TX20 1pc.	TX25 1pc.	TX30 1pc.	TX40 1pc.
61251			61261		
PH2 1pc.			PZ2 1pc.		

66006

DISPLAY MYBIT 15 TORSION+

ESPOSITORE DA BANCO PER 12 BIT-SETS
12 PCS. BIT-SET DISPLAY



12 pcs.

COD. **66006314**
€ 307,070



12 pcs.
COD. 66006310

185 X 40 X 195 mm



1. LINEE PREMIUM

PREMIUM LINES

66006

MYBIT 14 TORSION+ CON CRICCHETTO

ASSORTIMENTO 14 PCS. TORSION+ / CRICCHETTO
14 PCS. SET - BITS + BIT HOLDER AND RATCHET

COD. **66006510**

€ 42,890

14
pcs.



100 X 170 mm



61250			61260		
PH1 1pc.	PH2 1pc.	PH3 1pc.	PZ1 1pc.	PZ2 1pc.	PZ3 1pc.
61270					
TX10 1pc.	TX15 1pc.	TX20 1pc.	TX25 1pc.	TX30 1pc.	TX40 1pc.

INCLUSO
INCLUDED

COD. 62013005



COD. 64221030



66010

ASSORTIMENTI TORSION+

ASSORTIMENTO 31 PCS. - INSERTI + PORTAINSERITI
31 PCS. SET - BITS + BIT-HOLDER

COD. **66010035**

€ 51,391

31
pcs.



80 X 115 X 30 mm

61250			61260		
PH1 2pcs.	PH2 4pcs.	PH3 3pcs.	PZ1 2pcs.	PZ2 4pcs.	PZ3 3pcs.
61270					
TX20 3pcs.		TX25 3pcs.		TX30 3pcs.	TX40 3pcs.

INCLUSO
INCLUDED

COD. 62013005





66001

STORE 9 ASSORTIMENTI TORSION+

CASSETTIERA CON 9 SCOMPARTI PER ESPOSITORE MULTISTORE
DRAWERS WITH 9 COMPARTMENTS FOR MULTISTORE DISPLAY

COD. **66001065**

€ 205,800

**165
pcs.**



600 X 90 X 65 mm

61250			61260			61270		
PH1	PH2	PH3	PZ1	PZ2	PZ3	TX20	TX25	TX30
10pcs.	30pcs.	20pcs.	10pcs.	30pcs.	20pcs.	15pcs.	15pcs.	15pcs.



MULTI STORE

COD. 66001005VC

PER DETTAGLI E COMPOSIZIONE VEDERE P. 184
FOR DETAILS AND COMPOSITION SEE p.184



1. LINEE PREMIUM

PREMIUM LINES

66001

MULTI *BIT* ESPOSITORE INSERTI TORSION+

ESPOSITORE DA BANCO CON 25 SCOMPARTI
DISPLAY WITH 25 COMPARTMENTS

310
pcs.



COD. **66001315**

€ 725,043

 61250			 61260		
PH1 10pcs.	PH2 30pcs.	PH3 10pcs.	PZ1 10pcs.	PZ2 20pcs.	PZ3 10pcs.
 61270					
TX10 10pcs.	TX15 10pcs.	TX20 20pcs.	TX25 20pcs.	TX30 20pcs.	TX40 10pcs.
 61251			 61261		
PH1 10pcs.	PH2 10pcs.	PH3 10pcs.	PZ1 10pcs.	PZ2 10pcs.	PZ3 10pcs.
 61271					
TX10 10pcs.	TX15 10pcs.	TX20 10pcs.	TX25 10pcs.	TX30 10pcs.	TX40 10pcs.
					 62015010  10pcs.

445 X 465 X 210 mm

STRUTTURA IN POLIPROPILENE ALVEOLARE AUTOPORTANTE, 25 SCOMPARTI.
 SELF-SUPPORTING POLYPROPYLENE HONEYCOMB STRUCTURE, 25 COMPARTMENTS.

**66001****MULTI BOX ESPOSITORE MINIBOX TORSION+****ESPOSITORE DA BANCO PER MINIBOX**
DISPLAY STAND FOR MINIBOX270
pcs.COD. **66001515****€ 526,380**

370 X 545 X 220 mm

STRUTTURA IN FILO METALLICO DA BANCO ED APPENDIBILE ADATTA AD ACCOGLIERE
20 MISURE DIVERSE DI INSERTI CONFEZIONATI IN MINIBOX E DUE ARTICOLI ACCESSORI.
COUNTERTOP OR WALL-MOUNTED METAL WIRE STRUCTURE, SUITABLE FOR HOLDING BITS
IN 20 DIFFERENT SIZES, MINIBOX PACKED AND TWO ACCESSORIES.

			L mm	COD.	box
10 pcs.		PH1	25	61250005010	2
10 pcs.		PH2	25	61250010010	3
10 pcs.		PH3	25	61250015010	2
5 pcs.		PH2	50	61251010005	2
10 pcs.		PZ1	25	61260005010	2
10 pcs.		PZ2	25	61260010010	3
10 pcs.		PZ3	25	61260015010	2
5 pcs.		PZ2	50	61261010005	2
10 pcs.		TX15	25	61270010010	2
10 pcs.		TX20	25	61270015010	2
10 pcs.		TX25	25	61270020010	3
10 pcs.		TX30	25	61270030010	3
1 pc.		MYBIT 7		66002350	2
1 pc.		MYBIT 10		66005350	2
1 pc.				62016005001	3
1 pc.				62012010	3



INSERTI 1/4" CON RIVESTIMENTO AL DIAMANTE 1/4" bits with diamond coating

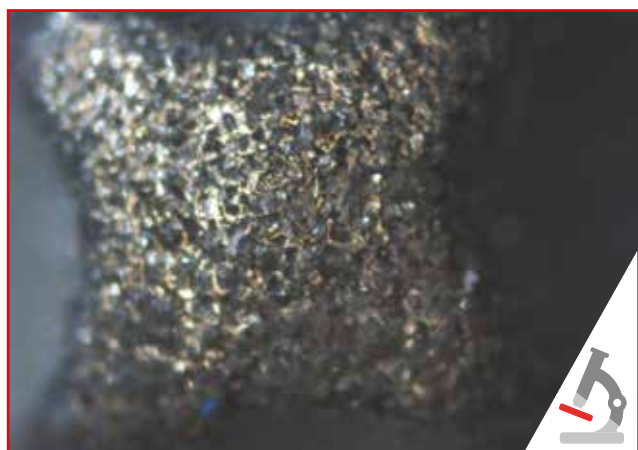

Rivestimento diamante
elettrodepositato
*Electro-deposited diamond
coating*



RIDUZIONE DELL'EFFETTO COME-OUT *Reduced come-out effect*

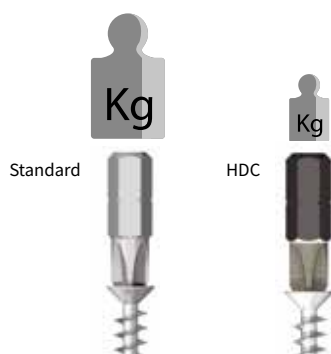

Applicazioni *applications*

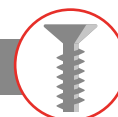

Le minuscole particelle di diamante fanno presa nella cava della vite, si riduce l'effetto come-out, l'operatore può avvitare con meno forza e più sicurezza.

The tiny diamond particles make grip in the screw recess, reducing the come-out recess effect; the operator may tighten with less force and more safety.



L'inserto non scivola dalla vite, diminuisce il rischio di rovinare sia la punta dell'utensile che la testa della vite.

The bit does not slip from the screw, which reduces the risk of damaging the tool tip and screw head.



L'ottimo grip che esercita questo rivestimento permette di utilizzare gli inserti HDC anche per svitare viti danneggiate o arrugginite.

The excellent grip exerted by this coating allows using HDC bits also to unscrew damaged or rusty screws.

**61310****PH HDC** **INSERTI 1/4" C PHILLIPS® - CON RIVESTIMENTO AL DIAMANTE**
1/4" C PHILLIPS® BITS - WITH DIAMOND COATING**58/60 HRC****EASYPACK** | sacchetto PVC con Euro-hole • PVC bags with Euro-hole

	L mm	PCS.	COD.	€ cad./each
PH1	25	10	61310005	2,974
PH2	25	10	61310010	2,974
PH3	25	10	61310015	2,974

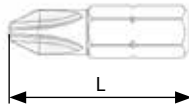
SELFPACK
2 pcs.

	L mm	COD.	€ box
PH1	25	61310005002	7,450
PH2	25	61310010002	7,450
PH3	25	61310015002	7,450

MINIBOX
10 pcs.

	L mm	COD.	€ box
PH1	25	61310005010	31,248
PH2	25	61310010010	31,248
PH3	25	61310015010	31,248

61311**PH HDC** **LAME 1/4" E PHILLIPS® - CON RIVESTIMENTO AL DIAMANTE**
1/4" E PHILLIPS® POWER BITS - WITH DIAMOND COATING**58/60 HRC****EASYPACK** | sacchetto PVC con Euro-hole • PVC bags with Euro-hole

	L mm	PCS.	COD.	€ cad./each
PH1	50	5	61311005	4,193
PH2	50	5	61311010	4,193
PH3	50	5	61311015	4,193

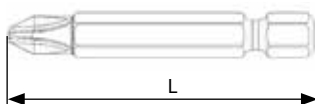
SELFPACK
2 pcs.

	L mm	COD.	€ box
PH1	50	61311005002	9,943
PH2	50	61311010002	9,943
PH3	50	61311015002	9,943

MINIBOX
5 pcs.

	L mm	COD.	€ box
PH1	50	61311005005	21,974
PH2	50	61311010005	21,974
PH3	50	61311015005	21,974



1. LINEE PREMIUM

PREMIUM LINES

61320

PZ HDC

INSERTI 1/4" C POZIDRIV® - CON RIVESTIMENTO AL DIAMANTE
1/4" C POZIDRIV® BITS - WITH DIAMOND COATING

58/60 HRC

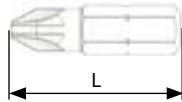

EASYPACK | sacchetto PVC con Euro-hole • PVC bags with Euro-hole

	L mm	PCS.	COD.	€ cad./each
PZ1	25	10	61320005	2,974
PZ2	25	10	61320010	2,974
PZ3	25	10	61320015	2,974



SELFPACK
2 pcs.

	L mm	COD.	€ box
PZ1	25	61320005002	7,450
PZ2	25	61320010002	7,450
PZ3	25	61320015002	7,450



MINIBOX
10 pcs.

	L mm	COD.	€ box
PZ1	25	61320005010	31,248
PZ2	25	61320010010	31,248
PZ3	25	61320015010	31,248

61321

PZ HDC

LAME 1/4" E POZIDRIV® - CON RIVESTIMENTO AL DIAMANTE
1/4" E POZIDRIV® POWER BITS - WITH DIAMOND COATING

58/60 HRC

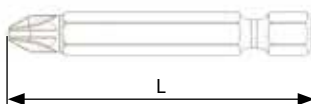

EASYPACK | sacchetto PVC con Euro-hole • PVC bags with Euro-hole

	L mm	PCS.	COD.	€ cad./each
PZ1	50	5	61321005	4,193
PZ2	50	5	61321010	4,193
PZ3	50	5	61321015	4,193



SELFPACK
2 pcs.

	L mm	COD.	€ box
PZ1	50	61321005002	9,943
PZ2	50	61321010002	9,943
PZ3	50	61321015002	9,943



MINIBOX
5 pcs.

	L mm	COD.	€ box
PZ1	50	61321005005	21,974
PZ2	50	61321010005	21,974
PZ3	50	61321015005	21,974

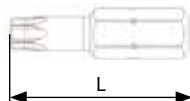
**61330****TX HDC** **INSERTI 1/4" C PER VITI TORX® - CON RIVESTIMENTO AL DIAMANTE**
1/4" C BITS FOR TORX® SCREWS - WITH DIAMOND COATING**58/60 HRC****EASYPACK** | sacchetto PVC con Euro-hole • PVC bags with Euro-hole

	L mm	PCS.	COD.	€ cad./each
TX10	25	10	61330005	3,245
TX15	25	10	61330010	3,245
TX20	25	10	61330015	3,245
TX25	25	10	61330020	3,245
TX30	25	10	61330030	3,245
TX40	25	10	61330035	3,245

	L mm	COD.	€ box
TX10	25	61330005002	8,006
TX15	25	61330010002	8,006
TX20	25	61330015002	8,006
TX25	25	61330020002	8,006
TX30	25	61330030002	8,006
TX40	25	61330035002	8,006

SELFPACK
2 pcs.

	L mm	COD.	€ box
TX10	25	61330005010	34,070
TX15	25	61330010010	34,070
TX20	25	61330015010	34,070
TX25	25	61330020010	34,070
TX30	25	61330030010	34,070
TX40	25	61330035010	34,070

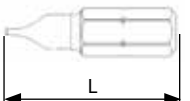
MINIBOX
10 pcs.**61305****TAGLIO HDC** **INSERTI 1/4" C A TAGLIO - CON RIVESTIMENTO AL DIAMANTE**
1/4" C SLOTTED BITS - WITH DIAMOND COATING**58/60 HRC****EASYPACK** | sacchetto PVC con Euro-hole • PVC bags with Euro-hole

	Ø mm	L mm	PCS.	COD.	€ cad./each
0,5	3	25	10	61305005	3,377
0,6	4	25	10	61305010	3,377
0,6	4,5	25	10	61305015	3,377
0,8	5,5	25	10	61305020	3,377
1,2	6,5	25	10	61305025	3,377

	Ø mm	L mm	COD.	€ box
0,5	3	25	61305005002	8,285
0,6	4	25	61305010002	8,285
0,6	4,5	25	61305015002	8,285
0,8	5,5	25	61305020002	8,285
1,2	6,5	25	61305025002	8,285

SELFPACK
2 pcs.

	Ø mm	L mm	COD.	€ box
0,5	3	25	61305005010	35,381
0,6	4	25	61305010010	35,381
0,6	4,5	25	61305015010	35,381
0,8	5,5	25	61305020010	35,381
1,2	6,5	25	61305025010	35,381

MINIBOX
10 pcs.



1. LINEE PREMIUM PREMIUM LINES

66002

MYBIT 7 ASSORTIMENTI HDC

ASSORTIMENTO 7 PCS. - INSERTI + PORTAINSERTI
7 PCS. SET - BITS + BIT-HOLDER



7
pcs.



100 X 120 mm



INCLUSO
INCLUDED
COD. 62015010



COD. **66002380**

€ 24,627

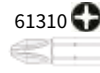

PH1
1pc.



PH2
1pc.



PZ1
1pc.



PZ2
1pc.



0,6x4,5
1pc.

1,2x6,5
1pc.

COD. **66002385**

€ 26,656



TX10
1pc.



TX15
1pc.



TX20
1pc.



TX25
1pc.



TX30
1pc.



TX40
1pc.

COD. **66002390**

€ 25,536



PH1
1pc.



PH2
1pc.



PZ1
1pc.



PZ2
1pc.

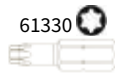

TX25
1pc.



TX30
1pc.

66002

DISPLAY MYBIT 7 HDC

ESPOSITORE DA BANCO PER 12 BIT-SETS
12 PCS. BIT-SET DISPLAY



12
pcs.

150 X 40 X 195 mm

COD. **66002384**

€ 282,670



12 pcs.
COD. 66002380

COD. **66002389**

€ 303,878



12 pcs.
COD. 66002385

COD. **66002394**

€ 291,110



12 pcs.
COD. 66002390



66007

MYBIT 7 POWER ASSORTIMENTI HDC

1.1

ASSORTIMENTO 7 PCS. - INSERTI
7 PCS. SET - BITS



7
pcs.

COD. **66007385**
€ 27,401

61311  L=50mm



PH1
1pc.

PH2
2pcs.

PH3
1pc.

61321  L=50mm



PZ1
1pc.

PZ2
1pc.

PZ3
1pc.



100 X 120 mm





1. LINEE PREMIUM PREMIUM LINES

66005

MYBIT 10 ASSORTIMENTI HDC

ASSORTIMENTO 10 PCS. - INSERTI + PORTAINSERTI
10 PCS. SET - BITS + BIT-HOLDER



10
pcs.



100 X 120 mm



INCLUSO
INCLUDED

COD. 62015010



COD. **66005380**

€ 31,752

61310			61320			61305		
PH1 1pc.	PH2 1pc.	PH3 1pc.	PZ1 1pc.	PZ2 1pc.	PZ3 1pc.	0,6x4,5 1pc.	0,8x5,5 1pc.	1,2x6,5 1pc.

COD. **66005385**

€ 31,349

61310			61320			61330		
PH1 1pc.	PH2 1pc.	PH3 1pc.	PZ1 1pc.	PZ2 1pc.	PZ3 1pc.	TX25 1pc.	TX30 1pc.	TX40 1pc.

66005

DISPLAY MYBIT 10 HDC

ESPOSITORE DA BANCO PER 12 BIT-SETS
12 PCS. BIT-SET DISPLAY



12
pcs.

150 X 40 X 195 mm

COD. **66005384**

€ 364,090



12 pcs.
COD. 66005380

COD. **66005389**

€ 359,466



12 pcs.
COD. 66005385



66006

MYBIT 15 ASSORTIMENTI HDC

ASSORTIMENTO 15 PCS. - INSERTI + PORTAINSERTI

15 PCS. SET - BITS + BIT-HOLDER



15 pcs.



100 X 167 mm



INCLUSO
INCLUDED
COD. 62015010



COD. 66006320

€ 48,888

61310			61320		
PH1	PH2	PH3	PZ1	PZ2	PZ3
1pc.	1pc.	1pc.	1pc.	1pc.	1pc.
61330			61305		
TX20	TX25	TX30	0,6x4,0	0,8x5,5	1,2x6,5
1pc.	1pc.	1pc.	1pc.	1pc.	1pc.
61311			61321		
PH2			PZ2		
1pc.			1pc.		

66006

DISPLAY MYBIT 15 HDC

ESPOSITORE DA BANCO PER 12 BIT-SETS

12 PCS. BIT-SET DISPLAY



12 pcs.

COD. 66006324

€ 559,440



12 pcs.
COD. 66006320

185 X 40 X 195 mm



1. LINEE PREMIUM

PREMIUM LINES

66006

MYBIT/4 HDC CON CRICCHETTO

ASSORTIMENTO 14 PCS. HDC / CRICCHETTO

14 PCS. SET - BITS + BIT HOLDER AND RATCHET

COD. **66006515**

€ 62,597

14
pcs.



100 X 170 mm



61310			61320		
PH1 1pc.	PH2 1pc.	PH3 1pc.	PZ1 1pc.	PZ2 1pc.	PZ3 1pc.
61330			61305		
TX20 1pc.	TX25 1pc.	TX30 1pc.	4x0,6 1pc.	5,5x0,8 1pc.	6,5x1,2 1pc.

INCLUSO
INCLUDED

COD. 62015010

COD. 64221030



66010

ASSORTIMENTI HDC

ASSORTIMENTO 31 PCS. - INSERTI + PORTAINSERTI

31 PCS. SET - BITS + BIT-HOLDER

COD. **66010040**

€ 106,898

31
pcs.



80 X 115 X 30 mm

61310			61320		
PH1 2pcs.	PH2 2pcs.	PH3 2pcs.	PZ1 2pcs.	PZ2 2pcs.	PZ3 2pcs.
61330			61305		
TX10 1pc.	TX15 1pc.	TX20 1pc.	TX25 2pcs.	TX30 2pcs.	TX40 2pcs.
0,5x3,0 1pc.	0,6x4,0 2pcs.	0,6x4,5 2pcs.	0,8x5,5 2pcs.	1,2x6,5 2pcs.	

INCLUSO
INCLUDED

COD. 62015010





66001

STORE 9 ASSORTIMENTI HDC

CASSETTIERA CON 9 SCOMPARTI PER ESPOSITORE MULTISTORE
DRAWERS WITH 9 COMPARTMENTS FOR MULTISTORE DISPLAY

110
pcs.



600 X 90 X 65 mm



MULTI STORE

COD. 66001005VC

PER DETTAGLI E COMPOSIZIONE VEDERE P. 184
FOR DETAILS AND COMPOSITION SEE p.184

COD. **66001070**

€ 304,584

61310		61320		61330			61305	
PH2	PH3	PZ2	PZ3	TX25	TX30	TX40	0,6x4,5	1,2x6,5
20pcs.	10pcs.	20pcs.	10pcs.	10pcs.	10pcs.	10pcs.	10pcs.	10pcs.

COD. **66001071**

€ 318,696

61310		61320		61330		
PH1	PH2	PZ1	PZ2	TX25	TX30	TX40
10pcs.	20pcs.	10pcs.	20pcs.	10pcs.	10pcs.	10pcs.

61311	61321
PH2	PZ2
10pcs.	10pcs.



1. LINEE PREMIUM

PREMIUM LINES

66001

MULTI *BIT* ESPOSITORE INSERTI HDC

ESPOSITORE DA BANCO CON 25 SCOMPARTI
DISPLAY WITH 25 COMPARTMENTS

265
pcs.





















445 X 465 X 210 mm

STRUTTURA IN POLIPROPILENE ALVEOLARE AUTOPORTANTE, 25 SCOMPARTI.
 SELF-SUPPORTING POLYPROPYLENE HONEYCOMB STRUCTURE, 25 COMPARTMENTS.

COD. **66001320**

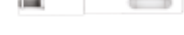
€ 927,629

61310  			61320  		
PH1 10pcs.	PH2 20pcs.	PH3 10pcs.	PZ1 10pcs.	PZ2 20pcs.	PZ3 10pcs.
61330  					
TX10 10pcs.	TX15 10pcs.	TX20 10pcs.	TX25 10pcs.	TX30 10pcs.	TX40 10pcs.
61311  			61321  		
PH1 10pcs.	PH2 10pcs.	PH3 10pcs.	PZ1 10pcs.	PZ2 10pcs.	PZ3 10pcs.
61305  					
0,5x3,0 10pcs.	0,6x4,0 10pcs.	0,6x4,5 10pcs.	0,8x5,5 10pcs.	1,2x6,5 10pcs.	
62015010    			62022005    		
10pcs.			5pcs		

**66001****MULTI BOX ESPOSITORE MINIBOX HDC****ESPOSITORE DA BANCO PER MINIBOX**
DISPLAY STAND FOR MINIBOX138
pcs.COD. **66001525****€ 545,440**

370 X 545 X 220 mm

STRUTTURA IN FILO METALLICO DA BANCO ED APPENDIBILE ADATTA AD ACCOGLIERE
20 MISURE DIVERSE DI INSERTI CONFEZIONATI IN MINIBOX E DUE ARTICOLI ACCESSORI.
COUNTERTOP OR WALL-MOUNTED METAL WIRE STRUCTURE, SUITABLE FOR HOLDING BITS
IN 20 DIFFERENT SIZES, MINIBOX PACKED AND TWO ACCESSORIES.

			L mm	COD.	box
10 pcs.		PH1	25	61310005010	1
10 pcs.		PH2	25	61310010010	2
10 pcs.		PH3	25	61310015010	1
5 pcs.		PH2	50	61311010005	1
10 pcs.		PZ1	25	61320005010	1
10 pcs.		PZ2	25	61320010010	2
10 pcs.		PZ3	25	61320015010	1
5 pcs.		PZ2	50	61321010005	1
10 pcs.		TX30	25	61330030010	1
10 pcs.		TX40	25	61330035010	1
10 pcs.		0,6 X 4,5	25	61305015010	1
10 pcs.		0,8 X 5,5	25	61305020010	1
1 pc.		MYBIT 7		66002380	1
1 pc.		MYBIT 7 POWER		66007385	1
1 pc.				62015005001	3
1 pc.				62029005	3

TITANIUM



INSERTI 1/4" CON RIVESTIMENTO AL NITRURO DI TITANIO
1/4" bits with titanium nitride coating



Rivestimento nitruro di titanio PVD - TiN
PVD titanium-nitride coating - TiN

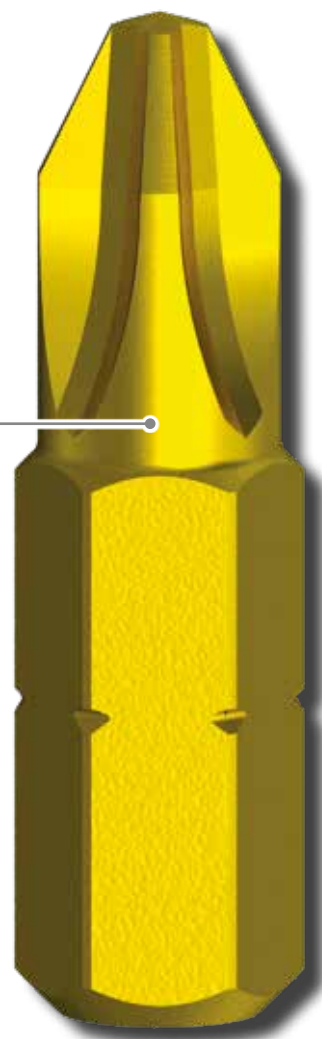
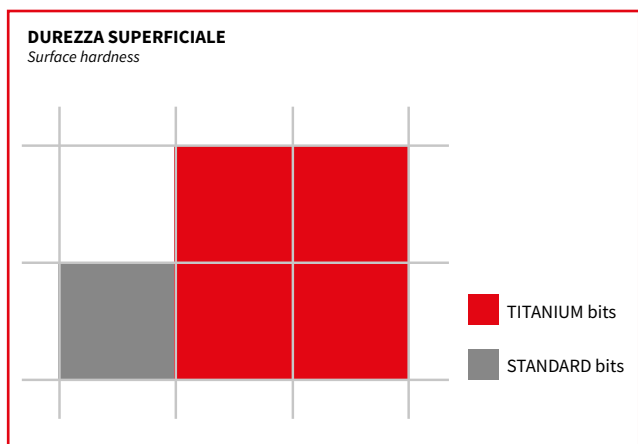

Applicazioni
applications

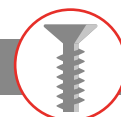

Rivestimento al nitruro di titanio estremamente duro (2500 HV), ottima resistenza all'usura e all'ossidazione.

Extremely hard titanium-nitride coating (2500 HV), excellent resistance to wear and oxidation.



Per avvitiamenti multipli a bassi valori di coppia.

For low torque screwing jobs.



Il rivestimento permette all'utensile di sopportare al meglio elevate e ripetute sollecitazioni aumentandone la vita.

The coating allows the tool to better withstand high and repeated stress, thus increasing its life.

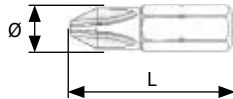
**61045****PH TITANIUM****INSERTI 1/4" C PHILLIPS® - RIVESTIMENTO NITRURO DI TITANIO****1/4" C PHILLIPS® BITS - TITANIUM NITRIDE COATING****59/60 HRC****EASYPACK** | sacchetto PVC con Euro-hole • PVC bags with Euro-hole

+	L mm	Ø mm	PCS.	COD.	€ cad./each
PH1	25	4,5	10	61045005	1,803
	25	4,5	10	61045010	1,803
PH2	25	6	10	61045015	1,803
PH3	25	6	10	61045020	1,803

**SELFPACK**
2 pcs.

+	L mm	COD.	€ box
PH1	25	61045005002	5,107
PH2	25	61045015002	5,107
PH3	25	61045020002	5,107

**MINIBOX**
10 pcs.

+	L mm	COD.	€ box
PH1	25	61045005010	18,932
PH2	25	61045015010	18,932
PH3	25	61045020010	18,932

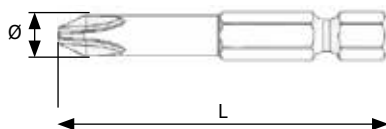
61052**PH TITANIUM****LAME 1/4" E PHILLIPS® - RIVESTIMENTO NITRURO DI TITANIO****1/4" E PHILLIPS® POWER BITS - TITANIUM NITRIDE COATING****59/60 HRC****EASYPACK** | sacchetto PVC con Euro-hole • PVC bags with Euro-hole

+	L mm	Ø mm	PCS.	COD.	€ cad./each
PH1	50	4,5	5	61052005	4,144
PH2	50	6	5	61052010	4,144
PH3	50	6	5	61052015	4,144

**SELFPACK**
2 pcs.

+	L mm	COD.	€ box
PH1	50	61052005002	9,778
PH2	50	61052010002	9,778
PH3	50	61052015002	9,778

**MINIBOX**
5 pcs.

+	L mm	COD.	€ box
PH1	50	61052005005	21,840
PH2	50	61052010005	21,840
PH3	50	61052015005	21,840



1. LINEE PREMIUM

PREMIUM LINES

61071

PZ TITANIUM

INSERTI 1/4" C POZIDRIV® - RIVESTIMENTO NITRURO DI TITANIO

1/4" C POZIDRIV® BITS - TITANIUM NITRIDE COATING

59/60 HRC

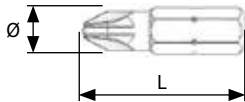

EASYPACK | sacchetto PVC con Euro-hole - PVC bags with Euro-hole

+	L mm	Ø mm	PCS.	COD.	€ cad./each
PZ1	25	4,5	10	61071005	1,803
PZ2	25	6	10	61071010	1,803
PZ3	25	6	10	61071015	1,803



+	L mm	COD.	€ box
PZ1	25	61071005002	5,107
PZ2	25	61071010002	5,107
PZ3	25	61071015002	5,107

SELPACK
2 pcs.



+	L mm	COD.	€ box
PZ1	25	61071005010	18,932
PZ2	25	61071010010	18,932
PZ3	25	61071015010	18,932

MINIBOX
10 pcs.

61078

PZ TITANIUM

LAME 1/4" E POZIDRIV® - RIVESTIMENTO NITRURO DI TITANIO

1/4" E POZIDRIV® POWER BITS - TITANIUM NITRIDE COATING

59/60 HRC



EASYPACK | sacchetto PVC con Euro-hole - PVC bags with Euro-hole

+	L mm	Ø mm	PCS.	COD.	€ cad./each
PZ1	50	4,5	5	61078005	4,144
PZ2	50	6	5	61078010	4,144
PZ3	50	6	5	61078015	4,144



+	L mm	COD.	€ box
PZ1	50	61078005002	9,778
PZ2	50	61078010002	9,778
PZ3	50	61078015002	9,778

SELPACK
2 pcs.



+	L mm	COD.	€ box
PZ1	50	61078005005	21,840
PZ2	50	61078010005	21,840
PZ3	50	61078015005	21,840

MINIBOX
5 pcs.

**61095****TX TITANIUM**

INSERTI 1/4" C PER VITI TORX® - RIVESTIMENTO NITRURO DI TITANIO
1/4" C BITS FOR TORX® SCREWS - TITANIUM NITRIDE COATING

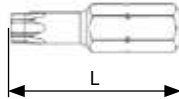
59/60 HRC

EASYPACK | sacchetto PVC con Euro-hole - PVC bags with Euro-hole

	L mm	PCS.	COD.	€ cad./each
TX10	25	10	61095005	2,208
TX15	25	10	61095010	2,208
TX20	25	10	61095015	2,208
TX25	25	10	61095020	2,208
TX27	25	10	61095025	2,208
TX30	25	10	61095030	2,208
TX40	25	10	61095035	2,208

	L mm	COD.	€ box
TX10	25	61095005002	5,922
TX15	25	61095010002	5,922
TX20	25	61095015002	5,922
TX25	25	61095020002	5,922
TX27	25	61095025002	5,922
TX30	25	61095030002	5,922
TX40	25	61095035002	5,922

SELFPACK
2 pcs.MINIBOX
10 pcs.

	L mm	COD.	€ box
TX10	25	61095005010	23,186
TX15	25	61095010010	23,186
TX20	25	61095015010	23,186
TX25	25	61095020010	23,186
TX27	25	61095025010	23,186
TX30	25	61095030010	23,186
TX40	25	61095035010	23,186

61026**TAGLIO TITANIUM**

INSERTI 1/4" C A TAGLIO - RIVESTIMENTO NITRURO DI TITANIO
1/4" C SLOTTED BITS - TITANIUM NITRIDE COATING

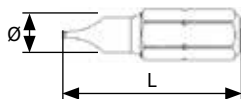
59/60 HRC

EASYPACK | sacchetto PVC con Euro-hole - PVC bags with Euro-hole

	Ø mm	L mm	PCS.	COD.	€ cad./each
0,5	3	25	10	61026001	2,554
0,6	4	25	10	61026005	2,554
0,6	4,5	25	10	61026008	2,554
0,8	5,5	25	10	61026010	2,554
1,2	6,5	25	10	61026015	2,554

	Ø mm	L mm	COD.	€ box
0,5	3	25	61026001002	6,608
0,6	4	25	61026005002	6,608
0,6	4,5	25	61026008002	6,608
0,8	5,5	25	61026010002	6,608
1,2	6,5	25	61026015002	6,608

SELFPACK
2 pcs.MINIBOX
10 pcs.

	Ø mm	L mm	COD.	€ box
0,5	3	25	61026001010	26,817
0,6	4	25	61026005010	26,817
0,6	4,5	25	61026008010	26,817
0,8	5,5	25	61026010010	26,817
1,2	6,5	25	61026015010	26,817



1. LINEE PREMIUM PREMIUM LINES

66002

MYBIT 7 ASSORTIMENTI TITANIUM

ASSORTIMENTO 7 PCS. - INSERTI + PORTAINSERTI
7 PCS. SET - BITS + BIT-HOLDER



7
pcs.

COD. **66002110**
€ 18,463

61045		61071		61026	
PH1	PH2	PZ1	PZ2	0,6x4,5	1,2x6,5
1pc.	1pc.	1pc.	1pc.	1pc.	1pc.

COD. **66002130**
€ 18,110

61045		61071		61095	
PH1	PH2	PZ1	PZ2	TX15	TX20
1pc.	1pc.	1pc.	1pc.	1pc.	1pc.



100 X 120 mm



INCLUSO
INCLUDED
COD. 62013005



66002

DISPLAY MYBIT 7 TITANIUM

ESPOSITORE DA BANCO PER 12 BIT-SETS
12 PCS. BIT-SET DISPLAY



12
pcs.

COD. **66002113**
€ 204,678



12 pcs.
COD. 66002110

COD. **66002134**
€ 206,976



12 pcs.
COD. 66002130

150 X 40 X 195 mm



66007

MYBIT 7 POWER ASSORTIMENTI TITANIUM

ASSORTIMENTO 7 PCS. - INSERTI
7 PCS. SET - BITS



7
pcs.

COD. **66007150**
€ 27,989

61451  L=50mm



PH1
1pc.

PH2
2pcs.

PH3
1pc.

61461  L=50mm



PZ1
1pc.

PZ2
1pc.

PZ3
1pc.



100 X 120 mm





1. LINEE PREMIUM PREMIUM LINES

66005

MYBIT 10 ASSORTIMENTI TITANIUM

ASSORTIMENTO 10 PCS. - INSERTI + PORTAINSERTI
10 PCS. SET - BITS + BIT-HOLDER



10
pcs.



100 X 120 mm



INCLUSO
INCLUDED

COD. 62013005



COD. **66005110**

€ 24,343

61045			61071			61026		
PH1	PH2	PH3	PZ1	PZ2	PZ3	0,6x4,5	0,8x5,5	1,2x6,5
1pc.	1pc.	1pc.	1pc.	1pc.	1pc.	1pc.	1pc.	1pc.

COD. **66005130**

€ 24,416

61045		61071		61095		61026		
PH1	PH2	PZ1	PZ2	TX25	TX30	0,6x4,5	0,8x5,5	1,2x6,5
1pc.	1pc.	1pc.	1pc.	1pc.	1pc.	1pc.	1pc.	1pc.

66005

DISPLAY MYBIT 10 TITANIUM

ESPOSITORE DA BANCO PER 12 BIT-SETS
12 PCS. BIT-SET DISPLAY



12
pcs.

150 X 40 X 195 mm

COD. **66005114**

€ 278,208



12 pcs.
COD. 66005110

COD. **66005134**

€ 278,342



12 pcs.
COD. 66005130



66006

MYBIT 15 ASSORTIMENTI TITANIUM

ASSORTIMENTO 15 PCS. - INSERTI + PORTAINSERI
15 PCS. SET - BITS + BIT-HOLDER



15 pcs.

COD. **66006040**
€ 36,338

61045			61071		
PH1 1pc.	PH2 1pc.	PH3 1pc.	PZ1 1pc.	PZ2 1pc.	PZ3 1pc.
61095			61026		
TX20 1pc.	TX25 1pc.	TX30 1pc.	TX40 1pc.	0,6x4,0 1pc.	0,8x5,5 1pc.
61052			61078		
PH2 1pc.			PZ2 1pc.		



100 X 167 mm



INCLUSO
INCLUDED
COD. 62013005



66006

DISPLAY MYBIT 15 TITANIUM

ESPOSITORE DA BANCO PER 12 BIT-SETS
12 PCS. BIT-SET DISPLAY



12 pcs.

COD. **66006044**
€ 415,296

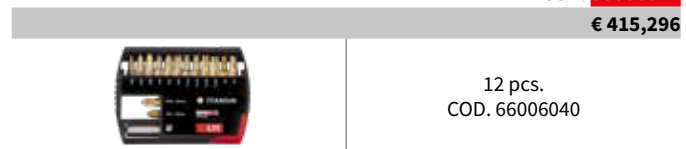

12 pcs.
COD. 66006040

185 X 40 X 195 mm



1. LINEE PREMIUM

PREMIUM LINES

66006

MYBIT 14 TITANIUM CON CRICCHETTO

ASSORTIMENTO 14 PCS. TITANIUM / CRICCHETTO

14 PCS. SET - BITS + BIT HOLDER AND RATCHET

COD. **66006520**

€ 48,171

14
pcs.



100 X 170 mm



61045			61071		
PH1 1pc.	PH2 1pc.	PH3 1pc.	PZ1 1pc.	PZ2 1pc.	PZ3 1pc.
61095				61026	
TX20 1pc.	TX25 1pc.	TX30 1pc.	TX40 1pc.	4x0,6 1pc.	5,5x0,8 1pc.

INCLUSO / INCLUDED
INCLUDE / INCLUIDO

COD. 62013005



COD. 64221030



66010

ASSORTIMENTI TITANIUM

ASSORTIMENTO 31 PCS. - INSERTI + PORTAININSERTI

31 PCS. SET - BITS + BIT-HOLDER

COD. **66010010**

€ 62,093

31
pcs.



80 X 115 X 30 mm

61045			61071			
PH1 2pcs.	PH2 3pcs.	PH3 1pc.	PZ1 2pcs.	PZ2 3pcs.	PZ3 1pc.	
61095						
TX10 2pcs.	TX15 2pcs.	TX20 2pcs.	TX25 2pcs.	TX27 2pcs.	TX30 2pcs.	TX40 2pcs.
61026						
0,5x3,0 1pc.	0,6x4,0 1pc.	0,8x5,5 1pc.	1,2x6,5 1pc.			

INCLUSO
INCLUDED

COD. 62013005







**66001****STORE 9 ASSORTIMENTI TITANIUM****CASSETTIERA CON 9 SCOMPARTI PER ESPOSITORE MULTISTORE**
DRAWERS WITH 9 COMPARTMENTS FOR MULTISTORE DISPLAY150
pcs.

600 X 90 X 65 mm



COD. **66001050**

€ 265,574

61045 		61071 		61095 			61026 	
PH1	PH2	PZ1	PZ2	TX25	TX30	TX40	0,6x4,0	1,2x6,5
20pcs.	30pcs.	20pcs.	30pcs.	10pcs.	10pcs.	10pcs.	10pcs.	10pcs.

COD. **66001051**

€ 258,406

61045 		61071 		61095 				
PH1	PH2	PZ1	PZ2	TX15	TX20	TX25	TX30	TX40
20pcs.	30pcs.	20pcs.	30pcs.	10pcs.	10pcs.	10pcs.	10pcs.	10pcs.

**MULTI STORE**

COD. 66001005VC

PER DETTAGLI E COMPOSIZIONE VEDERE P. 184
FOR DETAILS AND COMPOSITION SEE p.184



1. LINEE PREMIUM

PREMIUM LINES

66001

MULTI **BIT** ESPOSITORE INSERTI TITANIUM

ESPOSITORE DA BANCO CON 25 SCOMPARTI
DISPLAY WITH 25 COMPARTMENTS

270
pcs.



















445 X 465 X 210 mm

STRUTTURA IN POLIPROPILENE ALVEOLARE AUTOPORTANTE, 25 SCOMPARTI.
 SELF-SUPPORTING POLYPROPYLENE HONEYCOMB STRUCTURE, 25 COMPARTMENTS.

COD. **66001325**

€ 696,394

61045   PH1 10pcs. PH2 20pcs. PH3 10pcs.			61071   PZ1 10pcs. PZ2 20pcs. PZ3 10pcs.			
61095   TX10 10pcs. TX15 10pcs. TX20 10pcs. TX25 10pcs. TX27 10pcs. TX30 10pcs. TX40 10pcs.						
61052   PH1 10pcs. PH2 10pcs. PH3 10pcs.			61078   PZ1 10pcs. PZ2 10pcs. PZ3 10pcs.			
61026   0,5x3,0 10pcs. 0,6x4,0 10pcs. 0,6x4,5 10pcs. 0,8x5,5 10pcs. 1,2x6,5 10pcs.					62015010     10pcs.	

**66001****MULTI BOX ESPOSITORE MINIBOX TITANIUM****ESPOSITORE DA BANCO PER MINIBOX**
DISPLAY STAND FOR MINIBOX270
pcs.COD. **66001520****€ 721,448**

			L mm	COD.	box
10 pcs.		PH1	25	61045005010	2
10 pcs.		PH2	25	61045015010	3
10 pcs.		PH3	25	61045020010	2
5 pcs.		PH2	50	61052010005	2
10 pcs.		PZ1	25	61071005010	2
10 pcs.		PZ2	25	61071010010	3
10 pcs.		PZ3	25	61071015010	2
5 pcs.		PZ2	50	61078010005	2
10 pcs.		TX20	25	61095015010	2
10 pcs.		TX25	25	61095020010	2
10 pcs.		TX30	25	61095030010	3
10 pcs.		TX40	25	61095035010	3
1 pc.		MYBIT 7		66002110	2
1 pc.		MYBIT 10		66005110	2
1 pc.		C		62015005001	3
1 pc.		E		62020010001	3

370 X 545 X 220 mm

STRUTTURA IN FILO METALLICO DA BANCO ED APPENDIBILE ADATTA AD ACCOGLIERE
20 MISURE DIVERSE DI INSERTI CONFEZIONATI IN MINIBOX E DUE ARTICOLI ACCESSORI.
COUNTERTOP OR WALL-MOUNTED METAL WIRE STRUCTURE, SUITABLE FOR HOLDING BITS
IN 20 DIFFERENT SIZES, MINIBOX PACKED AND TWO ACCESSORIES.



INSERTI 1/4" REALIZZATI IN ACCIAIO INOX 1/4" stainless steel bits

RESISTENZA ALLA CORROSIONE IN ATMOSFERA SALINA Resistance to corrosion in saline atmospheres

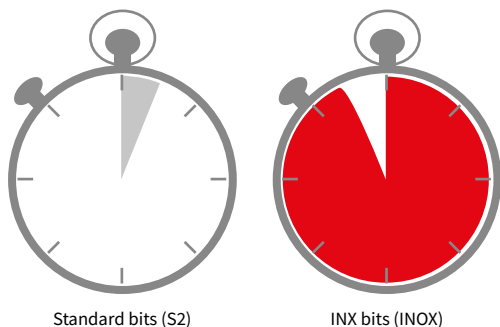

RAPPORTO RESISTENZA ALL'USURA-RINVENIMENTO CRIOGENICO Wear resistance-cryogenic recovery ratio

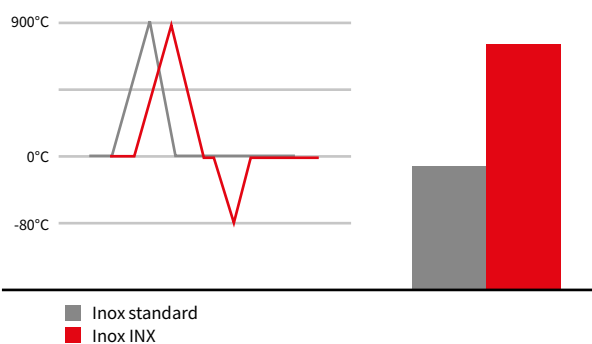

Applicazioni
applications

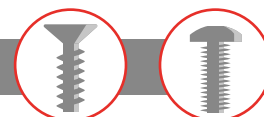

Interamente realizzati in acciaio inossidabile.
Made entirely of stainless steel.



Per lavori in condizioni estreme: resistono alla corrosione anche a contatto con acqua di mare.
For extreme conditions applications: corrosion resistant, even in contact with seawater.

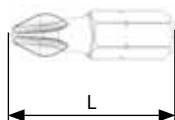

Indicati per l'uso con viteria INOX in quanto non provocano / innescano ossidazioni.
Suitable for use with stainless steel screws as they do not cause or generate oxidation.

**61410****PH INX** **INSERTI 1/4" C PHILLIPS® - IN ACCIAIO INOX**
1/4" C PHILLIPS® BITS - IN STAINLESS STEEL**54/56 HRC****EASYPACK** | sacchetto PVC con Euro-hole • PVC bags with Euro-hole

	L mm	PCS.	COD.	€ cad./each
PH1	25	10	61410005	2,554
PH2	25	10	61410010	2,554
PH3	25	10	61410015	2,554

**SELPACK**
2 pcs.

	L mm	COD.	€ box
PH1	25	61410005002	6,608
PH2	25	61410010002	6,608
PH3	25	61410015002	6,608

**MINIBOX**
10 pcs.

	L mm	COD.	€ box
PH1	25	61410005010	26,768
PH2	25	61410010010	26,768
PH3	25	61410015010	26,768

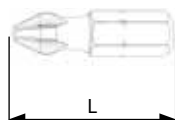
61420**PZ INX** **INSERTI 1/4" C POZIDRIV® - IN ACCIAIO INOX**
1/4" C POZIDRIV® BITS - IN STAINLESS STEEL**54/56 HRC****EASYPACK** | sacchetto PVC con Euro-hole • PVC bags with Euro-hole

	L mm	PCS.	COD.	€ cad./each
PZ1	25	10	61420005	2,554
PZ2	25	10	61420010	2,554
PZ3	25	10	61420015	2,554

**SELPACK**
2 pcs.

	L mm	COD.	€ box
PZ1	25	61420005002	6,608
PZ2	25	61420010002	6,608
PZ3	25	61420015002	6,608

**MINIBOX**
10 pcs.

	L mm	COD.	€ box
PZ1	25	61420005010	26,768
PZ2	25	61420010010	26,768
PZ3	25	61420015010	26,768



1. LINEE PREMIUM

PREMIUM LINES

61430

TX INX

INSERTI 1/4" C PER VITI TORX® - IN ACCIAIO INOX
1/4" C BITS FOR TORX® SCREWS - IN STAINLESS STEEL

54/56 HRC

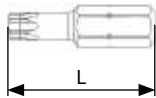

EASYPACK | sacchetto PVC con Euro-hole • PVC bags with Euro-hole

	L mm	PCS.	COD.	€ cad./each
TX10	25	10	61430005	2,856
TX15	25	10	61430010	2,856
TX20	25	10	61430015	2,856
TX25	25	10	61430020	2,856
TX30	25	10	61430030	2,856
TX40	25	10	61430035	2,856

	L mm	COD.	€ box
TX10	25	61430005002	7,202
TX15	25	61430010002	7,202
TX20	25	61430015002	7,202
TX25	25	61430020002	7,202
TX30	25	61430030002	7,202
TX40	25	61430035002	7,202



SELFPACK
2 pcs.



MINIBOX
10 pcs.

	L mm	COD.	€ box
TX10	25	61430005010	29,904
TX15	25	61430010010	29,904
TX20	25	61430015010	29,904
TX25	25	61430020010	29,904
TX30	25	61430030010	29,904
TX40	25	61430035010	29,904

61400

HEX INX

INSERTI 1/4" C ESAGONALI - IN ACCIAIO INOX
1/4" C HEX BITS - IN STAINLESS STEEL

54/56 HRC

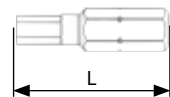

EASYPACK | sacchetto PVC con Euro-hole • PVC bags with Euro-hole

	L mm	PCS.	COD.	€ cad./each
2	25	10	61400005	3,158
2,5	25	10	61400010	3,158
3	25	10	61400015	3,158
4	25	10	61400020	3,158
5	25	10	61400025	3,158
6	25	10	61400030	3,158

	L mm	COD.	€ box
2	25	61400005002	7,806
2,5	25	61400010002	7,806
3	25	61400015002	7,806
4	25	61400020002	7,806
5	25	61400025002	7,806
6	25	61400030002	7,806



SELFPACK
2 pcs.



MINIBOX
10 pcs.

	L mm	COD.	€ box
2	25	61400005010	33,040
2,5	25	61400010010	33,040
3	25	61400015010	33,040
4	25	61400020010	33,040
5	25	61400025010	33,040
6	25	61400030010	33,040

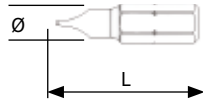
**61405****TAGLIO INX****INSERTI 1/4" C A TAGLIO - IN ACCIAIO INOX**
1/4" C SLOTTED BITS - IN STAINLESS STEEL**54/56 HRC**

EASYPACK | sacchetto PVC con Euro-hole - PVC bags with Euro-hole

Ø mm	L mm	PCS.	COD.	€ cad./each	
0,5	3	25	10	61405005	3,304
0,6	4	25	10	61405010	3,304
0,6	4,5	25	10	61405015	3,304
0,8	5,5	25	10	61405020	3,304
1,2	6,5	25	10	61405025	3,304

Ø mm	L mm	COD.	€ box	
0,5	3	25	61405005002	8,098
0,6	4	25	61405010002	8,098
0,6	4,5	25	61405015002	8,098
0,8	5,5	25	61405020002	8,098
1,2	6,5	25	61405025002	8,098

SELFPACK
2 pcs.MINIBOX
10 pcs.

Ø mm	L mm	COD.	€ box	
0,5	3	25	61405005010	34,720
0,6	4	25	61405010010	34,720
0,6	4,5	25	61405015010	34,720
0,8	5,5	25	61405020010	34,720
1,2	6,5	25	61405025010	34,720

Bacino di carenaggio di un cantiere navale.
Dry dock of a shipyard.



1. LINEE PREMIUM

PREMIUM LINES

62015

PORTAINSERTI INX

PORTAINSERTI 1/4"E IN ACCIAIO INOX INTEGRALE MAGNETICO CON ANELLO PER INSERTE 1/4"C
 1/4"E STAINLESS STEEL BIT HOLDER WITH C-RING AND MAGNET FOR 1/42C BITS



EASYPACK | sacchetto PVC con Euro-hole • PVC bags with Euro-hole

L mm	Ø mm	PCS.	COD.	€ cad./each
60	11	5	62015105	8,429



SELPACK
1 pc.

L mm	COD.	€ box
60	62015105001	9,961

62016

PORTAINSERTI INX MANDRINO DI BLOCCO

PORTAINSERTI 1/4"E IN ACCIAIO INOX MAGNETICO CON MANDRINO DI BLOCCO
 1/4"E STAINLESS STEEL BIT HOLDER WITH LOCK CHUCK AND MAGNET

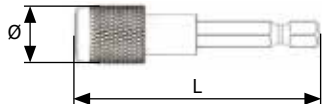

EASYPACK | sacchetto PVC con Euro-hole • PVC bags with Euro-hole

L mm	Ø mm	PCS.	COD.	€ cad./each
60	14	5	62016105	10,970



SELPACK
1 pc.

L mm	COD.	€ box
60	62016105001	12,584



FOCUS ON

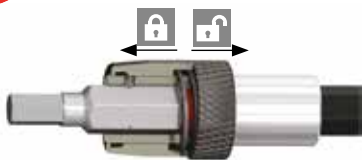

Le sfere di tenuta bloccano l'inserto: questo articolo è consigliato per l'uso con inserti esagonali che tendono a bloccarsi nella cava della vite.

The sealing balls block the bit: this article is recommended for use with hexagon bits that tend to become blocked in the slot of the screw.



66002

MYBIT 7 ASSORTIMENTI INX

ASSORTIMENTO 7 PCS. - INSERTI + PORTAINSERTI

7 PCS. SET - BITS + BIT-HOLDER



7 pcs.



100 X 120 mm



INCLUSO
INCLUDED

COD. 62015105



COD. 66002400

€ 25,430



PH1
1pc.

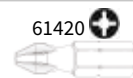

PH2
1pc.



PZ1
1pc.

PZ2
1pc.

0,6x4,5
1pc.

1,2x6,5
1pc.

COD. 66002405

€ 25,749



TX10
1pc.

TX15
1pc.

TX20
1pc.

TX25
1pc.

TX30
1pc.

TX40
1pc.

66002

DISPLAY MYBIT 7 INX

ESPOSITORE DA BANCO PER 12 BIT-SETS

12 PCS. BIT-SET DISPLAY



12 pcs.

150 X 40 X 195 mm

COD. 66002404

€ 289,094



12 pcs.
COD. 66002400

COD. 66002409

€ 292,723



12 pcs.
COD. 66002405



1. LINEE PREMIUM

PREMIUM LINES

66005

MYBIT 10 ASSORTIMENTI INX

ASSORTIMENTO 10 PCS. - INSERTI + PORTAINSERTI
10 PCS. SET - BITS + BIT-HOLDER



10 pcs.



100 X 120 mm



INCLUSO
INCLUDED

COD. 62015105



COD. **66005400**

€ 32,665

61410			61420			61405		
PH1	PH2	PH3	PZ1	PZ2	PZ3	0,6x4,5	0,8x5,5	1,2x6,5
1pc.	1pc.	1pc.	1pc.	1pc.	1pc.	1pc.	1pc.	1pc.

COD. **66005410**

€ 32,771

61410		61420		61430		61400		
PH2	PH3	PZ2	PZ3	TX20	TX25	4	5	6
1pc.	1pc.	1pc.	1pc.	1pc.	1pc.	1pc.	1pc.	1pc.

66005

DISPLAY MYBIT 10 INX

ESPOSITORE DA BANCO PER 12 BIT-SETS
12 PCS. BIT-SET DISPLAY



12 pcs.

150 X 40 X 195 mm

COD. **66005404**

€ 373,410



12 pcs.
COD. 66005400

COD. **66005414**

€ 376,696



12 pcs.
COD. 66005410



66006

MYBIT/4 INX CON CRICCHETTO

ASSORTIMENTO 14 PCS. INX / CRICCHETTO
14 PCS. SET - BITS + BIT HOLDER AND RATCHET

COD. **66006525**

€ 55,642

14 pcs.



61410			61420		
PH1	PH2	PH3	PZ1	PZ2	PZ3
1pc.	1pc.	1pc.	1pc.	1pc.	1pc.
61430			61405		
TX25	TX30	TX40	0,6x4,5	0,8x5,5	1,2x6,5
1pc.	1pc.	1pc.	1pc.	1pc.	1pc.



100 X 170 mm



INCLUSO / INCLUDED
INCLUDE / INCLUIDO

COD. 62015105

COD. 64221030

66010

ASSORTIMENTI INX

ASSORTIMENTO 31 PCS. - INSERTI + PORTAININSERTI
31 PCS. SET - BITS + BIT-HOLDER

COD. **66010045**

€ 92,669

31 pcs.



80 X 115 X 30 mm

61410			61420			
PH1	PH2	PH3	PZ1	PZ2	PZ3	
2pcs.	2pcs.	2pcs.	2pcs.	2pcs.	2pcs.	
61430			61405			
TX20	TX25	TX30	TX40	0,6x4,0	0,8x5,5	1,2x6,5
2pcs.	2pcs.	2pcs.	1pc.	1pc.	1pc.	1pc.
61400						
3	4	5	6			
2pcs.	2pcs.	2pcs.	2pcs.			

INCLUSO
INCLUDED

COD. 62015105

1. LINEE PREMIUM

PREMIUM LINES

66001

STORE 9 ASSORTIMENTI INX

CASSETTIERA CON 9 SCOMPARTI PER ESPOSITORE MULTISTORE
DRAWERS WITH 9 COMPARTMENTS FOR MULTISTORE DISPLAY







110
pcs.

600 X 90 X 65 mm



COD. **66001075**

€ 278,029

61410 		61420 		61400 			61405 	
PH1	PH2	PZ1	PZ2	3	4	5	0,8x5,5	1,2x6,5
10pcs.	20pcs.	10pcs.	20pcs.	10pcs.	10pcs.	10pcs.	10pcs.	10pcs.

COD. **66001076**

€ 257,242

61410 		61420 			61430 			
PH1	PH2	PH3	PZ1	PZ2	PZ3	TX20	TX25	TX30
10pcs.	20pcs.	10pcs.	10pcs.	20pcs.	10pcs.	10pcs.	10pcs.	10pcs.



MULTI STORE

COD. 66001005VC

PER DETTAGLI E COMPOSIZIONE VEDERE P. 184
 FOR DETAILS AND COMPOSITION SEE p.184



FOCUS ON

1.1

CORROSIONE

Gli acciai INOX sono leghe di ferro caratterizzate, oltre che dalle proprietà meccaniche tipiche degli acciai al carbonio, da una notevole resistenza alla corrosione. Tale capacità è dovuta alla presenza di elementi di lega, principalmente cromo, in grado di ricoprirsi di uno strato di ossidi aderente e invisibile che protegge il metallo sottostante dall'azione degli agenti chimici esterni (acqua, sale, altri metalli...). I principali tipi di corrosione a cui è soggetto l'acciaio INOX sono quella in ambiente salino (corrosione salina) oppure quella dovuta a contaminazione da altri metalli (corrosione galvanica). Proprio per quest'ultimo motivo è preferibile utilizzare gli inserti INOX con viteria INOX o, se ciò non fosse possibile, interporre del materiale isolante tra gli stessi.



Camera per test corrosione INOX in nebbia salina.

Chamber for STAINLESS STEEL corrosion tests in a saline mist.

CORROSION

Stainless steels are iron alloys characterised not only by the typical mechanical properties of carbon steel, but also by a remarkable resistance to corrosion. This ability comes from the presence of alloy elements, primarily chromium, which are able to cover themselves with an adhering and invisible oxide layer that protects the underlying metal against the action of external chemical agents (water, salt, other metals, etc.).

STAINLESS steel is particularly prone to corrosion in saline environments (saline corrosion) or corrosion caused by contamination with other metals (galvanic corrosion). For this last reason, it is preferable to use STAINLESS STEEL BITS with STAINLESS STEEL screws or, if this is not possible, to place insulating material between them.



Esempio di corrosione galvanica dovuta dall'accoppiamento di dadi e bulloni in acciaio INOX su una piastra in acciaio.

Example of galvanic corrosion caused by combining stainless steel details on a steel plate.

LTI®



INSERTI 1/4" CON CRESTE ANTISCIVOLAMENTO 1/4" bits with Anti Come-out Ribs

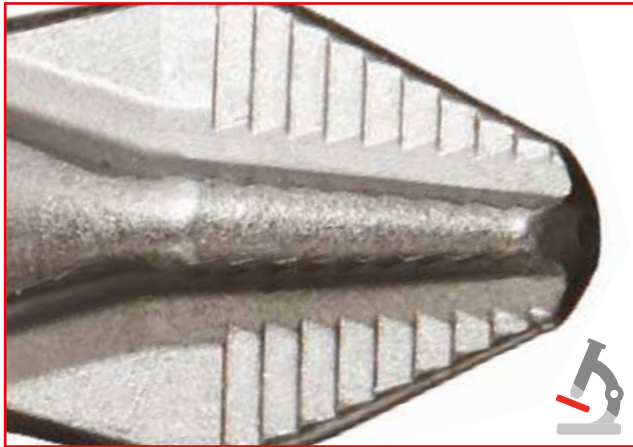

ACR = creste
antiscivolamento
ACR = nonslip
ridges



Applicazioni
applications



RIDUZIONE DELL'EFFETTO COME-OUT Reduced come-out effect

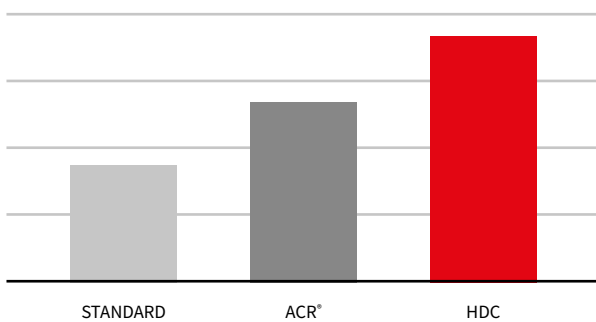

Ideali per applicazioni su materiali duri anche in presenza di ruggine: il sistema ACR[®] distribuisce più efficientemente la forza applicata.

Ideal for applications using hard materials, even in the presence of rust: the ACR[®] system distributes the force applied in a more efficient way.



Perfetta aderenza anche con viti verniciate o smaltate, tipiche del settore aeronautico.

Perfect grip even with painted or enamelled screws typically used in the aviation industry.



Le creste sulla punta dell'inserto aumentano l'aderenza nella cava della vite, riducendo lo scivolamento e il conseguente effetto come-out.

The ridges on the tip of the bit increase grip in the cavity of the screw, reducing slippage and consequently, the come-out effect.

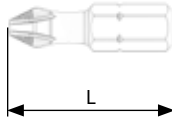
**61049****PH ACR®** **INSERTI 1/4" C PHILLIPS® ACR**
1/4" C PHILLIPS® ACR BITS**58/60 HRC****EASYPACK** | sacchetto PVC con Euro-hole • PVC bags with Euro-hole

	L mm	PCS.	COD.	€ cad./each
PH1	25	10	61049005	1,142
PH2	25	10	61049010	1,142
PH3	25	10	61049015	1,142

**SELFPACK**
2 pcs.

	L mm	COD.	€ box
PH1	25	61049005002	3,786
PH2	25	61049010002	3,786
PH3	25	61049015002	3,786

**MINIBOX**
10 pcs.

	L mm	COD.	€ box
PH1	25	61049005010	11,953
PH2	25	61049010010	11,953
PH3	25	61049015010	11,953

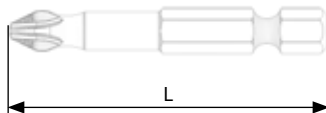
61060**PH ACR®** **LAME 1/4" E PHILLIPS® ACR**
1/4" E PHILLIPS® ACR POWER BITS**58/60 HRC****EASYPACK** | sacchetto PVC con Euro-hole • PVC bags with Euro-hole

	L mm	PCS.	COD.	€ cad./each
PH1	50	5	61060005	2,856
PH2	50	5	61060010	2,856
PH3	50	5	61060015	2,856

**SELFPACK**
2 pcs.

	L mm	COD.	€ box
PH1	50	61060005002	7,202
PH2	50	61060010002	7,202
PH3	50	61060015002	7,202

**MINIBOX**
5 pcs.

	L mm	COD.	€ box
PH1	50	61060005005	15,008
PH2	50	61060010005	15,008
PH3	50	61060015005	15,008



1. LINEE PREMIUM

PREMIUM LINES

61081

PZ ACR®



INSERTI 1/4" C POZIDRIV® ACR
1/4" C POZIDRIV® ACR BITS

58/60 HRC

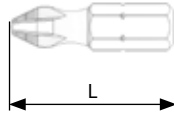

EASYPACK | sacchetto PVC con Euro-hole - PVC bags with Euro-hole

	L mm	PCS.	COD.	€ cad./each
PZ1	25	10	61081005	1,142
PZ2	25	10	61081010	1,142
PZ3	25	10	61081015	1,142



SELFPACK
2 pcs.

	L mm	COD.	€ box
PZ1	25	61081005002	3,786
PZ2	25	61081010002	3,786
PZ3	25	61081015002	3,786



MINIBOX
10 pcs.

	L mm	COD.	€ box
PZ1	25	61081005010	11,888
PZ2	25	61081010010	11,888
PZ3	25	61081015010	11,888

61085

PZ ACR®



LAME 1/4" E POZIDRIV® ACR
1/4" E POZIDRIV® ACR POWER BITS

58/60 HRC

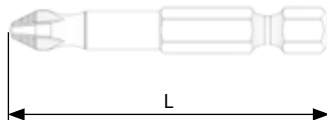

EASYPACK | sacchetto PVC con Euro-hole - PVC bags with Euro-hole

	L mm	PCS.	COD.	€ cad./each
PZ1	50	5	61085005	2,856
PZ2	50	5	61085010	2,856
PZ3	50	5	61085015	2,856



SELFPACK
2 pcs.

	L mm	COD.	€ box
PZ1	50	61085005002	7,202
PZ2	50	61085010002	7,202
PZ3	50	61085015002	7,202



MINIBOX
5 pcs.

	L mm	COD.	€ box
PZ1	50	61085005005	15,008
PZ2	50	61085010005	15,008
PZ3	50	61085015005	15,008



COME SCEGLIERE L'INSERTO PREMIUM

HOW TO CHOOSE THE RIGHT PREMIUM BIT

VITI AUTOFILETTANTI PER LEGNO

Self-tapping screws for wood

RECOMMENDED

p. 78

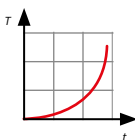

Lo sforzo cresce progressivamente fino al picco massimo quando la testa della vite penetra nel legno. In caso di legni duri questi sforzi possono essere elevati.

The stress grows progressively until reaching maximum peak when the head of the screw penetrates the wood. In case of hard wood, this stress can be very high.

VITI AUTOFILETTANTI PER METALLO

Self-tapping screws for metal

RECOMMENDED

p. 52 p. 66

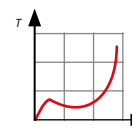

Lo sforzo, inizialmente elevato, diventa costante dopo la creazione del filetto, per poi raggiungere il picco al termine del lavoro.

The stress, initially high, becomes constant after the thread has been created, and then reaches its peak at the end of the work.

VITI AUTO-FORANTI

Self-drilling screws

RECOMMENDED

p. 32

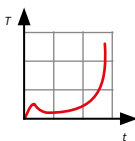

Nelle prime fasi si ha un picco di sforzo per la creazione di foro e filetto e le viti tendono a disallinearsi rischiando di rovinare il piano di avvitatura.

Given the particular use, when making the hole the screws tend to become misaligned and may ruin the material that is being worked.

VITI TRI-LOBATE

Tri-lobe screws

RECOMMENDED

p. 78

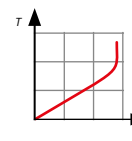
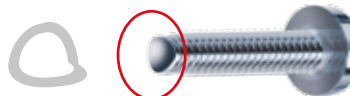

Data la particolare sezione della vite lo sforzo è molto elevato durante tutte le fasi dell'avvitatura.

Given the particular section of the screw, the stress is very high throughout the entire screwing operation.

VITI LUNGHE PER COPERTURE

Long screws for roofs

RECOMMENDED

p. 78 p. 52

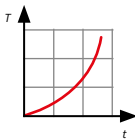

Durante la fase di avvitatura nel legno lo sforzo cresce repentinamente fino a raggiungere coppie estremamente elevate.

When screwing into wood, the stress increases until reaching extremely high torques.

VITI VERNICIATE O DANNEGGIATE

Painted or damaged screws

RECOMMENDED

p. 90 p. 124

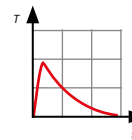

In presenza di teste di viti arrugginite o verniciate il grip dell'inserto tende a diminuire rendendo particolarmente difficoltose le operazioni.

In the presence of rusty or painted screw heads, the grip of the insert bit tends to decrease, making it particularly difficult to perform the operations.

T = TORSIONE - TORQUE

t = TEMPO - TIME























































Gli inserti con attacco da 1/4" rappresentano senza dubbio la parte più significativa del mercato degli utensili per avvitatori. Ogni produttore deve quindi essere in grado di offrire ai propri clienti una gamma sufficientemente ampia di forme e di lunghezze, così da poter "risolvere il problema" in ogni occasione. Le linee di prodotti standard (ESSENTIAL) che presentiamo in questa sezione rispondono esattamente a queste necessità. Anche il confezionamento ed i metodi di presentazione sul punto vendita costituiscono un'aspetto del prodotto. Per questo motivo abbiamo sviluppato nuove e diversificate soluzioni espositive, che vanno dal bit-set più semplice all'espositore più completo.

Insert with 1/4" attachment account for the largest slice of the market of tools for drivers. As a manufacturer, we are able to offer our customers a wide range of shapes and lengths, so that they can be the ideal choice for any application. The standard or ESSENTIAL product lines presented in this section perfectly meet these requirements. The packaging and presentation of the products in the store is also an important aspect and we have worked hard to develop a complete range of counter displays, which include innovative pocket-sized bit sets with a brand new design.



1.2

LINEE ESSENTIAL ESSENTIAL LINES

		1/4" PHILLIPS®	p. 132			1/4" TAGLIO SLOTTED	p. 154
		1/4" POZIDRIV®	p. 138			1/4" PLUS/MINUS TAGLIO/PH PLUS/MINUS SLOT/PH	p. 158
		1/4" PER VITI TORX® FOR TORX® SCREWS	p. 142			1/4" PLUS/MINUS TAGLIO/PZ PLUS/MINUS SLOT/PZ	p. 159
		1/4" PER VITI TORX® CON FORO FOR TORX® SCREWS WITH HOLE	p. 144			1/4" QUADRO SQUARE	p. 160
		1/4" CONICO PER VITI TORX® TAPERED FOR TORX® SCREWS	p. 146			1/4" SPANNER	p. 161
		1/4" CONICO PER VITI TORX® TAPERED FOR TORX® SCREWS	p. 147			1/4" TRI-WING®	p. 162
		1/4" PER VITI TORX-PLUS® FOR TORX-PLUS® SCREWS	p. 148			1/4" TORQ-SET®	p. 163
		1/4" PER VITI 5 LOBI FOR 5-LOBE SCREWS	p. 148			1/4" XZN	p. 164
		1/4" ESAGONO HEXAGON	p. 150			ASSI-SIT	p. 165
		1/4" ESAGONO SFERICO SPHERICAL HEXAGON	p. 152			1/4" PH DOPPIO DOUBLE PH	p. 166
		1/4" ESAGONO FORATO HEXAGON WITH HOLE	p. 153			1/4" PZ DOPPIO DOUBLE PZ	p. 166
		1/4" ESAGONO (POLLICI) HEXAGON (INCHES)	p. 153			1/4" DOPPI TAGLIO-PH DOUBLE SLOT-PH	p. 167
						1/4" DOPPI TAGLIO-PZ DOUBLE SLOT-PZ	p. 167
						1/4" CHIAVI A BUSSOLA NUT SETTERS	p. 188

ESSENTIAL

LINEE ESSENTIAL *Essential lines*

Lavorazioni meccaniche eseguite con moderne macchine a CNC di elevata affidabilità per conferire alle geometrie dell'inserto la precisione necessaria al miglior accoppiamento con la vite.
Mechanical processes performed with modern CNC machines to give the geometries of the bit the precision necessary for better screw coupling.

Acciaio di altà qualità al Cromo-Molibdeno-Vanadio temprato a cuore. Temperatura di rinvenimento calibrata per dare ad ogni tipologia la durezza ottimale.

High-quality chrome-molybdenum-vanadium hardened steel and recovery temperature calibrated to strengthen each insert bit to its maximum hardness.



La fosfatazione allo zinco come rivestimento superficiale conferisce a questa linea di prodotto un'ottima resistenza all'ossidazione.
Zinc phosphate as a surface coating offers this product line excellent oxidation resistance.



Controlli qualitativi e attenzione al customer satisfaction permettono di mantenere la qualità dei nostri prodotti sempre ai massimi livelli.

Strict quality controls and constant attention to customer satisfaction ensure that the quality of our products is always at the highest levels.



Grazie all'ottimo equilibrio tra durezza e tenacità, i nostri inserti ESSENTIAL non presentano rischi di rotture precoci e pericolose.

The perfect balance between hardness and toughness of our ESSENTIAL bits, prevent premature and dangerous breakage.

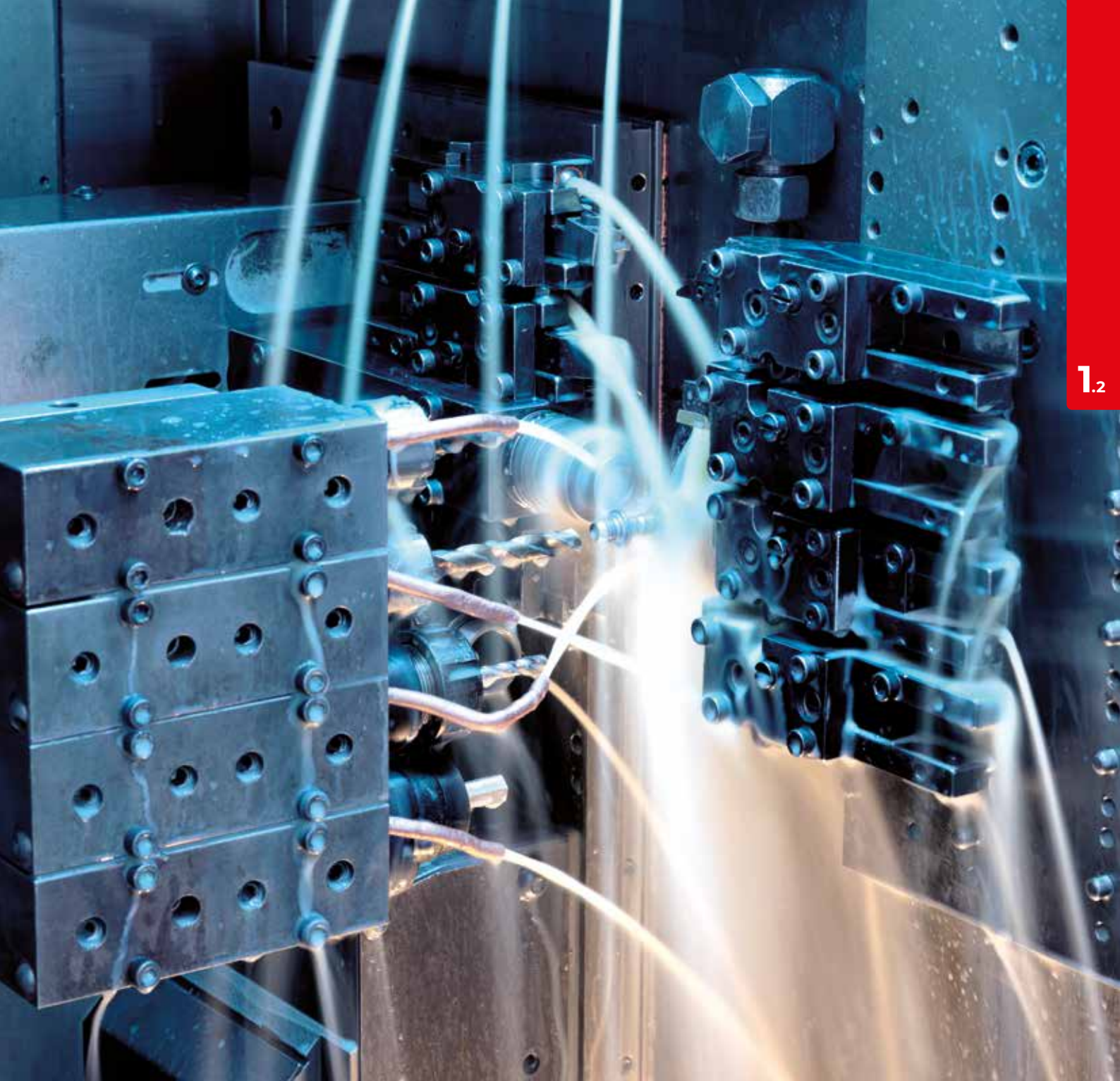

Particolare di una nostra macchina utensile: tornio CN a 10 assi ad alta precisione.
One of our machine tools: CN lathe with 10 high-precision axes.



1.2 LINEE ESSENTIAL

ESSENTIAL LINES

61043

PH FRESATI

INSERTI 1/4" C PHILLIPS® IMPRONTA FRESATA
1/4" C PHILLIPS® BITS MILLED TIP

58/60 HRC



EASYPACK | sacchetto PVC con Euro-hole • PVC bags with Euro-hole

	L mm	Ø mm	PCS.	COD.	€ cad./each
PH0	25	3	10	61043005	0,661
PH1	25	4,5	10	61043010	0,661
PH2	25	6	10	61043020	0,661
PH3	25	6	10	61043030	0,661
PH4	32	10	10	61043040	2,554

	L mm	COD.	€ box
PH0	25	61043005002	2,822
PH1	25	61043010002	2,822
PH2	25	61043020002	2,822
PH3	25	61043030002	2,822
PH4	32	61043040002	6,608



SELPACK
2 pcs.



MINIBOX
10 pcs.

	L mm	COD.	€ box
PH0	25	61043005010	6,866
PH1	25	61043010010	6,866
PH2	25	61043020010	6,866
PH3	25	61043030010	6,866
PH4	32	61043040010	28,094



TANKBOX
100 pcs.

	L mm	COD.	€ box
PH1	25	61043010100	52,900
PH2	25	61043020100	52,900
PH3	25	61043030100	52,900

61046

PH FRESATI

INSERTI 1/4" C PHILLIPS® IMPRONTA FRESATA TIPO LUNGO
1/4" C PHILLIPS® BITS LONG MILLED TIP

58/60 HRC

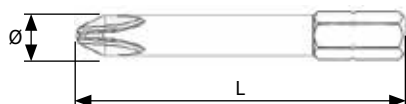

EASYPACK | sacchetto PVC con Euro-hole • PVC bags with Euro-hole

	L mm	Ø mm	PCS.	COD.	€ cad./each
PH1	50	4,5	5	61046005	1,893
PH2	50	6	5	61046010	1,893
PH3	50	8	5	61046015	3,214

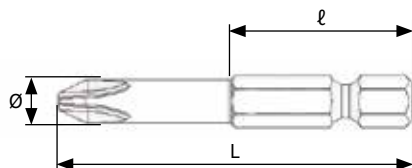
**61051****PH FRESATI****LAME 1/4" E PHILLIPS® IMPRONTA FRESATA****1/4" E PHILLIPS® POWER BITS MILLED TIP****58/60 HRC****EASYPACK** | sacchetto PVC con Euro-hole - PVC bags with Euro-hole

	L mm	l mm	Ø mm	PCS.	COD.	€ cad./each
PH0	50	25	3	5	61051005	3,234
	75	25	3	5	61051010	5,574
	100	25	3	5	61051015	12,936
PH1	50	25	4,5	5	61051020	1,929
	70	25	4,5	5	61051024	2,646
	75	25	4,5	5	61051030	2,682
	90	25	4,5	5	61051034	3,375
	100	25	4,5	5	61051035	3,564
	127	25	4,5	5	61051037	4,805
PH2	150	25	4,5	5	61051040	5,522
	200	25	4,5	5	61051178	12,656
	50	25	6	5	61051045	1,929
	70	25	6	5	61051055	2,646
	75	25	6	5	61051060	2,682
	90	25	6	5	61051065	3,375
	100	25	6	5	61051070	3,564
	120	25	6	5	61051075	4,682
PH3	127	25	6	5	61051077	4,805
	150	25	6	5	61051080	5,522
	200	25	6	5	61051315	12,656
	50	25	6	5	61051085	1,929
	50	25	8	5	61051088	3,881
	75	25	6	5	61051090	3,752
PH4	75	25	8	5	61051093	8,503
	100	25	6	5	61051095	4,822
	100	25	8	5	61051098	10,713
	150	25	8	5	61051100	18,704
PH4	50	25	10	5	61051105	5,668

	L mm	COD.	€ box
PH1	50	61051020002	5,370
	75	61051030002	6,872
	100	61051035002	8,620
PH2	50	61051045002	5,370
	75	61051060002	6,872
	100	61051070002	8,620
PH3	50	61051085002	5,370
PH4	50	61051105002	12,813

**SELPACK**
2 pcs.**MINIBOX**
5 pcs.

	L mm	COD.	€ box
PH1	50	61051020005	10,126
	75	61051030005	14,085
	100	61051035005	18,698
PH2	50	61051045005	10,126
	75	61051060005	14,085
	100	61051070005	18,698
PH3	50	61051085005	10,126
PH4	50	61051105005	28,448



1.2 LINEE ESSENTIAL

ESSENTIAL LINES

61051

PH FRESATI CORPO RIDOTTO

LAME 1/4" E PHILLIPS® CORPO RIDOTTO IMPRONTA FRESATA
 REDUCED BODY 1/4" E PHILLIPS® POWER BITS MILLED TIP

58/60 HRC

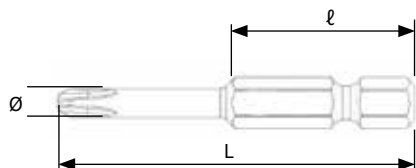

EASYPACK | sacchetto PVC con Euro-hole • PVC bags with Euro-hole

	L mm	ℓ mm	Ø mm	PCS.	COD.	€ cad./each
	50	25	3	5	61051110	7,244
PH1	75	25	3	5	61051125	9,643
	100	25	3	5	61051140	15,053
	50	25	4	5	61051200	7,232
	50	25	5	5	61051205	7,232
	75	25	3	5	61051215	9,643
PH2	75	25	4	5	61051225	9,643
	75	25	5	5	61051230	9,643
	100	25	4	5	61051240	14,582
	100	25	5	5	61051250	14,465



FOCUS ON



La fresatura, o più correttamente profilatura, è la lavorazione per asportazione di truciolo che viene eseguita per realizzare l'impronta dell'inserto. Noi la eseguiamo con apposite macchine costruite in Germania ed utensili per fresatura specifici per ogni misura di impronta. La profilatura, unitamente all'operazione di tornitura, riescono a garantire alle geometrie dell'inserto una precisione superiore rispetto al metodo di stampatura a freddo.

Milling, or more correctly, profiling, is the chip removal process which is performed to create the tip of the insert bit. We perform this with special milling machines and tools specific to each tip size. Profiling, together with the turning operation, gives the bit greater geometric precision than cold pressing.

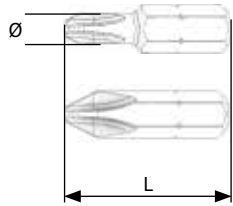
**61044****PH EXTRA-HARD****INSERTI 1/4" C EXTRA HARD PHILLIPS® IMPRONTA FRESATA**
EXTRA-HARD 1/4" C PHILLIPS® BITS MILLED TIP**60/62 HRC**

*61044020

EASYPACK | sacchetto PVC con Euro-hole - PVC bags with Euro-hole

	L mm	Ø mm	PCS.	COD.	€ cad./each
PH1	25	4,5	10	61044005	0,874
PH2	25	4,5	10	61044010	0,874
PH2	25	1/4	10	61044020*	0,874



	L mm	Ø mm	COD.	€ cad./each
PH1	25	4,5	61044005200	113,000
PH2	25	4,5	61044010200	113,000
PH2	25	1/4	61044020200	113,000

BIGBAG
200 pcs.**FOCUS ON**

Questi inserti sono specifici per utilizzi dove non siano applicate elevate coppie di serraggio: su legni teneri o lamiera. L'elevata durezza preserva l'integrità dell'impronta e aumenta l'efficienza dell'utensile.

These bits are specifically for applications that do not require the use of high torques: on soft wood or sheet metal. The extra hardness preserves the integrity of the tip and increases tool efficiency.

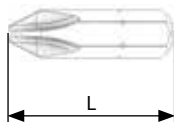
61047**PH ESAGONALI****INSERTI 1/4" C CORPO ESAGONALE PHILLIPS® IMPRONTA FRESATA**
HEXAGON BODY 1/4" C PHILLIPS® BITS MILLED TIP**58/60 HRC**

EASYPACK | sacchetto PVC con Euro-hole - PVC bags with Euro-hole

	L mm	PCS.	COD.	€ cad./each
PH1	25	10	61047005	0,784
PH2	25	10	61047015	0,784
PH3	25	10	61047025	0,784

**TIPS**

Il corpo pieno interamente esagonale permette di applicare la massima torsione.

The full hexagonal body allows applying the maximum torque.



1.2 LINEE ESSENTIAL

ESSENTIAL LINES

61048

PH STAMPATI

INSERTI 1/4" C PHILLIPS® IMPRONTA STAMPATA
1/4" C PHILLIPS® BITS FORGED TIP

58/60 HRC

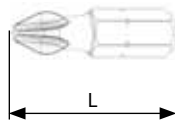

EASYPACK | sacchetto PVC con Euro-hole • PVC bags with Euro-hole

	L mm	PCS.	COD.	€ cad./each
PH1	25	10	61048005	0,638
PH2	25	10	61048015	0,638
PH3	25	10	61048025	0,638



SELPACK
2 pcs.

	L mm	COD.	€ box
PH1	25	61048005002	2,766
PH2	25	61048015002	2,766
PH3	25	61048025002	2,766



MINIBOX
10 pcs.

	L mm	COD.	€ box
PH1	25	61048005010	6,703
PH2	25	61048015010	6,703
PH3	25	61048025010	6,703

61056

PH STAMPATI

LAME 1/4" E PHILLIPS® IMPRONTA STAMPATA
1/4" E PHILLIPS® POWER BITS FORGED TIP

58/60 HRC

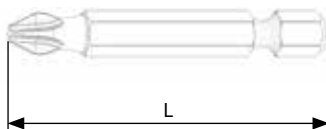
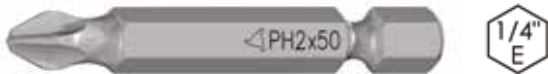

EASYPACK | sacchetto PVC con Euro-hole • PVC bags with Euro-hole

	L mm	PCS.	COD.	€ cad./each
PH1	50	5	61056030	1,747
PH2	50	5	61056035	1,747
PH3	50	5	61056040	1,747



SELPACK
2 pcs.

	L mm	COD.	€ box
PH1	50	61056030002	4,984
PH2	50	61056035002	4,984
PH3	50	61056040002	4,984



MINIBOX
5 pcs.

	L mm	COD.	€ box
PH1	50	61056030005	9,150
PH2	50	61056035005	9,150
PH3	50	61056040005	9,150



61057

PH CARTONGESSO

INSERTI 1/4" PHILLIPS® CON BUSSOLA DI FERMO PER CARTONGESSO
1/4" PHILLIPS® BITS WITH STOP FOR DRYWALL

58/60 HRC



L mm

PCS.

COD.

€
cad./each

PH2

25

10

61057010

1,658

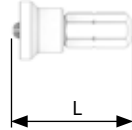

L mm

PCS.

COD.

€
cad./each

PH2

50

5

61057020

2,520

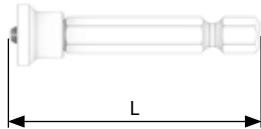

FOCUS ON



La bussola copre la testa della vite: in questo modo si evita di penetrare eccessivamente nel cartongesso facilitando così le operazioni di stuccatura.

The socket covers the head of the screw: this prevents excessive penetration into plasterboard, thus facilitating the grouting operations.



1.2 LINEE ESSENTIAL

ESSENTIAL LINES

61069

PZ FRESATI

INSERTI 1/4" C POZIDRIV® IMPRONTA FRESATA
1/4" C POZIDRIV® BITS MILLED TIP

58/60 HRC

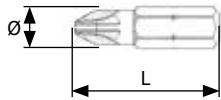

LTI	L mm	COD.	€ box
	PZ0 25	61069005002	2,822
	PZ1 25	61069010002	2,822
	PZ2 25	61069020002	2,822
	PZ3 25	61069030002	2,822
	PZ4 32	61069040002	6,608

SELPACK
2 pcs.

EASYPACK | sacchetto PVC con Euro-hole - PVC bags with Euro-hole

LTI	L mm	Ø mm	PCS.	COD.	€ cad./each
	PZ0 25	3	10	61069005	0,661
	PZ1 25	4,5	10	61069010	0,661
	PZ2 25	6	10	61069020	0,661
	PZ3 25	6	10	61069030	0,661
	PZ4 32	10	10	61069040	2,554

LTI	L mm	COD.	€ box
	PZ0 25	61069005010	6,866
	PZ1 25	61069010010	6,866
	PZ2 25	61069020010	6,866
	PZ3 25	61069030010	6,866
	PZ4 32	61069040010	28,094

MINIBOX
10 pcs.

LTI	L mm	COD.	€ box
	PZ1 25	61069010100	52,900
	PZ2 25	61069020100	52,900
	PZ3 32	61069030100	52,900

TANKBOX
100 pcs.

61075

PZ FRESATI

INSERTI 1/4" C POZIDRIV® IMPRONTA FRESATA TIPO LUNGO
1/4" C POZIDRIV® BITS LONG MILLED TIP

58/60 HRC

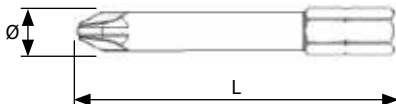

EASYPACK | sacchetto PVC con Euro-hole - PVC bags with Euro-hole

LTI	L mm	Ø mm	PCS.	COD.	€ cad./each
	PZ1 50	4,5	5	61075005	1,893
	PZ2 50	6	5	61075010	1,893
	PZ3 50	8	5	61075015	3,214

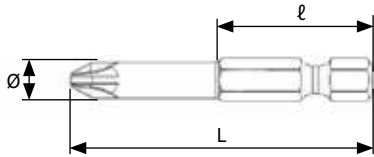
**61076****PZ FRESATI****LAME 1/4" E POZIDRIV® IMPRONTA FRESATA**
1/4" E POZIDRIV® POWER BITS MILLED TIP**58/60 HRC****EASYPACK** | sacchetto PVC con Euro-hole - PVC bags with Euro-hole

	L mm	l mm	Ø mm	PCS.	COD.	€ cad./each
PZ0	50	25	3	5	61076005	3,234
	50	25	4,5	5	61076010	1,929
	70	25	4,5	5	61076019	2,646
	75	25	4,5	5	61076020	2,682
PZ1	90	25	4,5	5	61076024	3,375
	100	25	4,5	5	61076025	3,564
	127	25	4,5	5	61076085	4,805
	150	25	4,5	5	61076030	5,522
	200	25	4,5	5	61076033	12,656
PZ2	50	25	6	5	61076035	1,929
	70	25	6	5	61076044	2,646
	75	25	6	5	61076045	2,682
	90	25	6	5	61076049	3,375
	100	25	6	5	61076050	3,564
	127	25	6	5	61076054	4,805
	150	25	6	5	61076055	5,522
	200	25	6	5	61076057	12,656
PZ3	50	25	6	5	61076060	1,929
	50	25	8	5	61076063	3,881
	75	25	6	5	61076065	3,752
	100	25	6	5	61076070	4,822
	100	25	8	5	61076073	10,713
PZ4	150	25	8	5	61076120	18,704
	50	25	10	5	61076075	5,668

	L mm	COD.	€ box
PZ1	50	61076010002	5,370
	75	61076020002	6,872
	100	61076025002	8,620
PZ2	50	61076035002	5,370
	75	61076045002	6,872
	100	61076050002	8,620
PZ3	50	61076060002	5,370
PZ4	50	61076075002	12,813

**SELPACK**
2 pcs.**MINIBOX**
5 pcs.

	L mm	COD.	€ box
PZ1	50	61076010005	10,126
	75	61076020005	14,085
	100	61076025005	18,698
PZ2	50	61076035005	10,126
	75	61076045005	14,085
	100	61076050005	18,698
PZ3	50	61076060005	10,126
	100	61076070005	24,108



1.2 LINEE ESSENTIAL

ESSENTIAL LINES

61070

PZ EXTRA-HARD

INSERTI 1/4" C POZIDRIV® IMPRONTA FRESATA EXTRA HARD
 1/4" C POZIDRIV® BITS EXTRA HARD MILLED TIP

60/62 HRC

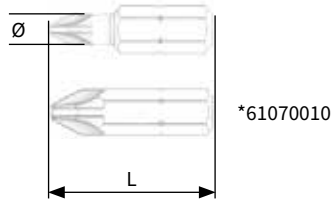

EASYPACK | sacchetto PVC con Euro-hole - PVC bags with Euro-hole

	L mm	Ø mm	PCS.	COD.	€ cad./each
PZ1	25	4,5	10	61070005	0,874
PZ2	25	4,5	10	61070008	0,874
PZ2	25	1/4	10	61070010*	0,874



BIGBAG
200 pcs.

	L mm	Ø mm	COD.	€ cad./each
PZ1	25	4,5	61070005200	113,000
PZ2	25	4,5	61070008200	113,000
PZ2	25	6,3	61070010200	113,000

61072

PZ ESAGONALI

INSERTI 1/4" C POZIDRIV® IMPRONTA FRESATA CORPO ESAGONALE
 1/4" C POZIDRIV® BITS MILLED TIP HEXAGON BODY

58/60 HRC

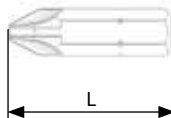

EASYPACK | sacchetto PVC con Euro-hole - PVC bags with Euro-hole

	L mm	PCS.	COD.	€ cad./each
PZ1	25	10	61072005	0,784
PZ2	25	10	61072010	0,784
PZ3	25	10	61072015	0,784



TIPS

Il corpo pieno interamente esagonale permette di applicare la massima torsione.

The full hexagonal body allows applying the maximum torque.

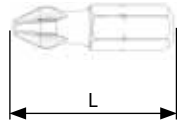
**61073****PZ STAMPATI****INSERTI 1/4" C POZIDRIV® IMPRONTA STAMPATA**
1/4" C POZIDRIV® BITS FORGED TIP**58/60 HRC****EASYPACK** | sacchetto PVC con Euro-hole - PVC bags with Euro-hole

	L mm	PCS.	COD.	€ cad./each
PZ1	25	10	61073005	0,638
PZ2	25	10	61073015	0,638
PZ3	25	10	61073025	0,638

**SELPACK**
2 pcs.

	L mm	COD.	€ box
PZ1	25	61073005002	2,766
PZ2	25	61073015002	2,766
PZ3	25	61073025002	2,766

**MINIBOX**
10 pcs.

	L mm	COD.	€ box
PZ1	25	61073005010	6,703
PZ2	25	61073015010	6,703
PZ3	25	61073025010	6,703

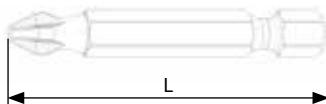
61082**PZ STAMPATI****LAME 1/4" E POZIDRIV® IMPRONTA STAMPATA**
1/4" E POZIDRIV® POWER BITS FORGED TIP**58/60 HRC****EASYPACK** | sacchetto PVC con Euro-hole - PVC bags with Euro-hole

	L mm	PCS.	COD.	€ cad./each
PZ1	50	5	61082030	1,747
PZ2	50	5	61082035	1,747
PZ3	50	5	61082040	1,747

**SELPACK**
2 pcs.

	L mm	COD.	€ box
PZ1	50	61082030002	4,984
PZ2	50	61082035002	4,984
PZ3	50	61082040002	4,984

**MINIBOX**
5 pcs.

	L mm	COD.	€ box
PZ1	50	61082030005	9,150
PZ2	50	61082035005	9,150
PZ3	50	61082040005	9,150



1.2 LINEE ESSENTIAL

ESSENTIAL LINES

61094

TX

INSERTI 1/4" C PER VITI TORX®
1/4" C BITS FOR TORX® SCREWS

58/60 HRC

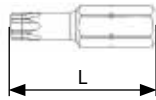

EASYPACK | sacchetto PVC con Euro-hole - PVC bags with Euro-hole

	L mm	PCS.	COD.	€ cad./each
TX06	25	10	61094005	1,028
TX07	25	10	61094010	1,028
TX08	25	10	61094015	1,028
TX09	25	10	61094020	1,028
TX10	25	10	61094025	1,028
TX15	25	10	61094030	1,028
TX20	25	10	61094035	1,028
TX25	25	10	61094040	1,028
TX27	25	10	61094045	1,028
TX30	25	10	61094050	1,028
TX40	25	10	61094055	1,028
TX45	25	10	61094060	2,429
TX50	25	10	61094065	2,429

	L mm	COD.	€ box
TX06	25	61094005002	3,559
TX07	25	61094010002	3,559
TX08	25	61094015002	3,559
TX09	25	61094020002	3,559
TX10	25	61094025002	3,559
TX15	25	61094030002	3,559
TX20	25	61094035002	3,559
TX25	25	61094040002	3,559
TX27	25	61094045002	3,559
TX30	25	61094050002	3,559
TX40	25	61094055002	3,559



SELFPACK
2 pcs.



MINIBOX
10 pcs.

	L mm	COD.	€ box
TX06	25	61094005010	10,811
TX07	25	61094010010	10,811
TX08	25	61094015010	10,811
TX09	25	61094020010	10,811
TX10	25	61094025010	10,811
TX15	25	61094030010	10,811
TX20	25	61094035010	10,811
TX25	25	61094040010	10,811
TX27	25	61094045010	10,811
TX30	25	61094050010	10,811
TX40	25	61094055010	10,811

	L mm	COD.	€ box
TX10	25	61094025100	82,260
TX15	25	61094030100	82,260
TX20	25	61094035100	82,260
TX25	25	61094040100	82,260
TX30	25	61094050100	82,260
TX40	25	61094055100	82,260

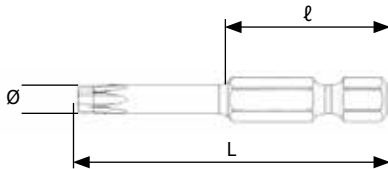

TANKBOX
100 pcs.

**61097****TX****LAME 1/4"E PER VITI TORX®****1/4"E POWER BITS FOR TORX® SCREWS****58/60 HRC**

EASYPACK | sacchetto PVC con Euro-hole • PVC bags with Euro-hole

	L mm	l mm	Ø mm	PCS.	COD.	€ cad./each
TX05	50	25	3	5	61097005	5,701
	50	25	3	5	61097010	5,701
TX06	70	25	3	5	61097012	6,608
	100	25	3	5	61097014	8,162
TX07	150	25	3	5	61097165	13,328
	50	25	3	5	61097015	5,701
TX08	70	25	3	5	61097017	6,608
	50	25	3	5	61097020	5,701
TX09	70	25	3	5	61097130	6,608
	100	25	3	5	61097133	9,183
TX10	150	25	3	5	61097170	13,328
	50	25	3	5	61097025	5,701
TX11	50	25	4	5	61097030	3,450
	70	25	4	5	61097035	5,107
TX12	90	25	4	5	61097039	6,673
	100	25	4	5	61097040	6,754
TX13	127	25	4	5	61097043	8,930
	150	25	4	5	61097160	10,662
TX14	200	25	4	5	61097205	16,374
	50	25	4	5	61097045	3,450
TX15	70	25	4	5	61097050	5,107
	90	25	4	5	61097054	6,673
TX16	100	25	4	5	61097055	6,754
	127	25	4	5	61097058	8,930
TX17	150	25	4	5	61097135	10,662
	200	25	5	5	61097210	16,374

	L mm	l mm	Ø mm	PCS.	COD.	€ cad./each
TX18	50	25	4,5	5	61097060	3,450
	70	25	5	5	61097065	5,107
TX19	90	25	5	5	61097069	6,673
	100	25	5	5	61097070	6,754
TX20	127	25	5	5	61097073	8,930
	150	25	5	5	61097140	10,662
TX21	200	25	5	5	61097215	16,374
	50	25	5	5	61097075	3,450
TX22	70	25	5	5	61097080	5,107
	90	25	5	5	61097084	6,673
TX23	100	25	5	5	61097085	6,754
	127	25	5	5	61097088	8,930
TX24	150	25	5	5	61097145	10,662
	200	25	5	5	61097220	16,374
TX25	50	25	6	5	61097090	3,450
	70	25	6	5	61097095	5,107
TX26	90	25	6	5	61097099	6,673
	100	25	6	5	61097100	6,754
TX27	127	25	6	5	61097102	8,930
	50	25	6	5	61097105	3,450
TX28	70	25	6	5	61097110	5,107
	90	25	6	5	61097114	6,673
TX29	100	25	6	5	61097115	6,754
	127	25	6	5	61097118	8,930
TX30	150	25	6	5	61097150	10,662
	50	25	1/4	5	61097120	3,450
TX31	70	25	1/4	5	61097125	5,107
	90	25	1/4	5	61097127	6,673
TX32	100	25	1/4	5	61097126	6,754
	150	25	1/4	5	61097128	10,662

	L mm	COD.	€ box
TX10	50	61097030002	8,400
TX15	50	61097045002	8,400
TX20	50	61097060002	8,400
TX25	50	61097075002	8,400
TX27	50	61097090002	8,400
TX30	50	61097105002	8,400
TX40	50	61097120002	8,400

	L mm	COD.	€ box
TX10	50	61097030005	18,113
TX15	50	61097045005	18,113
TX20	50	61097060005	18,113
TX25	50	61097075005	18,113
TX27	50	61097090005	18,113
TX30	50	61097105005	18,113
TX40	50	61097120005	18,113

SELFPACK
2 pcs.MINIBOX
5 pcs.



1.2 LINEE ESSENTIAL

ESSENTIAL LINES

61111

TXH CON FORO

INSERTI 1/4" C PER VITI TORX® ANTI-MANOMISSIONE
1/4" C BITS FOR TORX® SCREWS TAMPER-RESISTANT

58/60 HRC

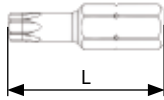

EASYPACK | sacchetto PVC con Euro-hole - PVC bags with Euro-hole

	L mm	PCS.	COD.	€ cad./each
TXH09	25	10	61111005	1,893
TXH10	25	10	61111010	1,893
TXH15	25	10	61111015	1,893
TXH20	25	10	61111020	1,893
TXH25	25	10	61111025	1,893
TXH27	25	10	61111030	1,893
TXH30	25	10	61111035	1,893
TXH40	25	10	61111040	1,893

	L mm	COD.	€ box
TXH09	25	61111005002	5,286
TXH10	25	61111010002	5,286
TXH15	25	61111015002	5,286
TXH20	25	61111020002	5,286
TXH25	25	61111025002	5,286
TXH27	25	61111030002	5,286
TXH30	25	61111035002	5,286
TXH40	25	61111040002	5,286



SELPACK
2 pcs.

	L mm	COD.	€ box
TXH09	25	61111005010	20,048
TXH10	25	61111010010	20,048
TXH15	25	61111015010	20,048
TXH20	25	61111020010	20,048
TXH25	25	61111025010	20,048
TXH27	25	61111030010	20,048
TXH30	25	61111035010	20,048
TXH40	25	61111040010	20,048

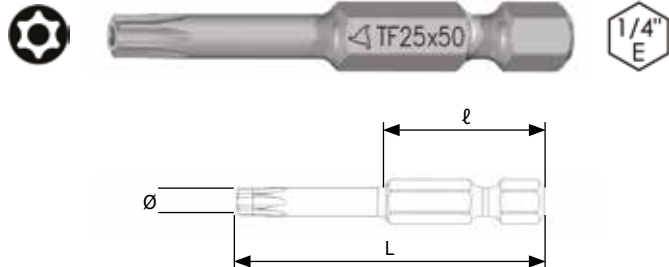

MINIBOX
10 pcs.

**61113****TXH CON FORO****LAME 1/4" E PER VITI TORX® ANTI-MANOMISSIONE****1/4" E POWER BITS FOR TORX® SCREWS TAMPER-RESISTANT****58/60 HRC****EASYPACK** | sacchetto PVC con Euro-hole - PVC bags with Euro-hole

	L mm	l mm	Ø mm	PCS.	COD.	€ cad./each
TXH10	50	25	4	5	61113005	4,682
	75	25	4	5	61113050	10,237
	100	25	4	5	61113055	13,888
TXH15	150	25	4	5	61113060	20,048
	50	25	4	5	61113010	4,682
	75	25	4	5	61113070	10,237
TXH20	100	25	4	5	61113075	13,888
	150	25	4	5	61113080	20,048
	50	25	4,5	5	61113015	4,682
TXH25	75	25	4,5	5	61113090	10,237
	100	25	4,5	5	61113095	13,888
	150	25	4,5	5	61113100	20,048
TXH27	50	25	5	5	61113020	4,682
	75	25	5	5	61113110	10,237
	100	25	5	5	61113115	13,888
TXH30	50	25	5,5	5	61113025	4,682
	75	25	5,5	5	61113120	10,237
	100	25	5,5	5	61113125	13,888
TXH40	50	25	6	5	61113030	4,682
	75	25	6	5	61113130	10,237
	100	25	6	5	61113135	13,888
TXH40	50	25	1/4	5	61113035	4,682
	75	25	1/4	5	61113140	10,237

	L mm	COD.	€ box
TXH10	50	61113005002	10,864
TXH15	50	61113010002	10,864
TXH20	50	61113015002	10,864
TXH25	50	61113020002	10,864
TXH27	50	61113025002	10,864
TXH30	50	61113030002	10,864
TXH40	50	61113035002	10,864

	L mm	COD.	€ box
TXH10	50	61113005005	24,640
TXH15	50	61113010005	24,640
TXH20	50	61113015005	24,640
TXH25	50	61113020005	24,640
TXH27	50	61113025005	24,640
TXH30	50	61113030005	24,640
TXH40	50	61113035005	24,640

**SELFPACK**
2 pcs.**MINIBOX**
5 pcs.**FOCUS ON**

Le viti con impronta THX antimanomissione sono spesso utilizzate per l'assemblaggio di piccoli elettrodomestici per escludere rischi di manomissione da personale non qualificato.

Screws with tamper-proof THX tip are often used in the assembly of small household appliances to eliminate the risk of tampering by unqualified people.

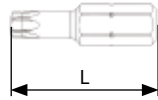

1.2 LINEE ESSENTIAL ESSENTIAL LINES

61101**TW CONICI****INSERTI 1/4" C PER VITI TORX® CONICHE**
1/4" C BITS FOR TORX® SCREWS WEDGE TIP**58/60 HRC****EASYPACK** | sacchetto PVC con Euro-hole - PVC bags with Euro-hole

	L mm	PCS.	COD.	€ cad./each
T06W	25	10	61101005	4,088
T07W	25	10	61101010	4,088
T08W	25	10	61101015	4,088
T09W	25	10	61101020	4,088
T10W	25	10	61101025	1,568
T15W	25	10	61101030	1,568
T20W	25	10	61101035	1,568
T25W	25	10	61101040	1,568
T27W	25	10	61101045	1,568
T30W	25	10	61101050	1,568
T40W	25	10	61101055	1,568

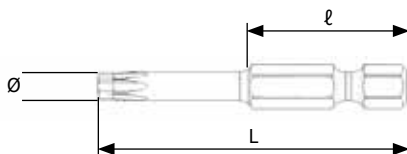
61102**TW CONICI****LAME 1/4" E PER VITI TORX® CONICHE**
1/4" E POWER BITS FOR TORX® SCREWS WEDGE TIP**58/60 HRC****EASYPACK** | sacchetto PVC con Euro-hole - PVC bags with Euro-hole

	L mm	ℓ mm	Ø mm	PCS.	COD.	€ cad./each
T10W	70	25	4	5	61102005	7,202
T15W	70	25	5	5	61102010	7,202
T20W	70	25	5	5	61102015	7,202
T25W	70	25	6	5	61102020	7,202
T27W	70	25	6	5	61102025	7,202
T30W	70	25	6	5	61102030	7,202
T40W	70	25	1/4	5	61102035	7,202

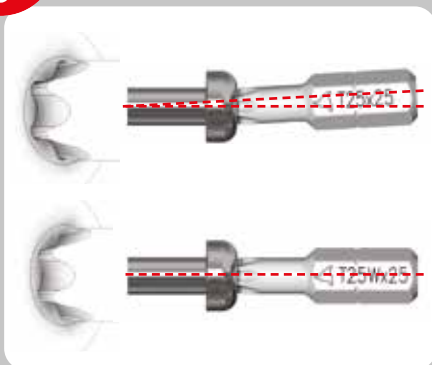
**FOCUS ON**

L'impronta TX conica raggiunge il massimo della tolleranza dimensionale.

- Tutto il profilo dell'inserto aderisce alla cava della vite (mentre la standard è sempre leggermente lasca), trasmette più uniformemente la coppia di serraggio e si consuma meno.
- L'inserto rimane in asse con la vite rendendo più veloce e sicura l'avvitatura.

The tapered TX tip reaches the maximum dimensional tolerance.

- The entire profile of the insert sticks to the cavity of the screw, while the standard is always slightly loose, spreading the tightening torque more evenly and contributing significantly to less wear and tear.
- The bit remains in axis with the screw for faster and safer screwing.



61139

TX CON PERNO DI CENTRAGGIO

INSERTI 1/4" C CON PERNO DI CENTRAGGIO PER VITI TORX®
1/4" C WITH CENTERING PIN BITS FOR TORX® SCREWS

58/60 HRC

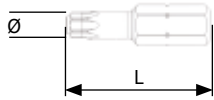

EASYPACK | sacchetto PVC con Euro-hole - PVC bags with Euro-hole

	L mm	PCS.	COD.	€ cad./each
TX10	25	10	61139005	1,624
TX15	25	10	61139010	1,624
TX20	25	10	61139015	1,624
TX25	25	10	61139020	1,624
TX27	25	10	61139025	1,624
TX30	25	10	61139030	1,624
TX40	25	10	61139035	1,624



FOCUS ON



Le viti con foro di centraggio sono principalmente usate per lavorazioni su legno e plastica. L'utilizzo con lo specifico inserto assicura il perfetto centraggio durante la lavorazione.

Screws with centering hole are mainly used for working on wood and plastic. Use with the specific bit ensures perfect centring during the machining process.



**Dettaglio
realizzazione interni
di un edificio.**

*Detail of internal
building construction.*



1.2 LINEE ESSENTIAL

ESSENTIAL LINES

61121

PER VITI TORX-PLUS® IPR 5 LOBI

INSERTI 1/4" C PER VITI (IPR) TORX-PLUS® ANTI-MANOMISSIONE

1/4" C BITS FOR TORX-PLUS® TAMPER-RESISTANT SCREWS (IPR)

58/60 HRC

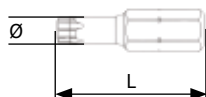

EASYPACK | sacchetto PVC con Euro-hole - PVC bags with Euro-hole

Ø	L mm	Ø mm	PCS.	COD.	€ cad./each
10	25	2,7	10	61121005	2,677
15	25	3,3	10	61121010	2,677
20	25	3,9	10	61121015	2,677
25	25	4,3	10	61121020	2,677
27	25	4,9	10	61121025	2,677
30	25	5,5	10	61121030	2,677
40	25	6,3	10	61121035	2,677



FOCUS ON



Le viti TORX-PLUS® IPR trovano vasta applicazione nel campo degli assemblaggi meccanici. La loro particolare forma garantisce un'inviolabilità quasi assoluta.

TORX-PLUS® IP screws come from the evolution of the traditional TORX® tip to ensure high resistance to torsional stress. This type of tip is used in the mechanical field and to clamp turning tools.

61123

PER VITI TORX-PLUS® IP

INSERTI 1/4" C PER VITI (IP) TORX-PLUS®

1/4" C BITS FOR TORX-PLUS® SCREWS (IP)

58/60 HRC

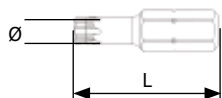

EASYPACK | sacchetto PVC con Euro-hole - PVC bags with Euro-hole

Ø	L mm	PCS.	COD.	€ cad./each
10IP	25	10	61123005	2,541
15IP	25	10	61123010	2,541
20IP	25	10	61123015	2,541
25IP	25	10	61123020	2,541
27IP	25	10	61123025	2,541
30IP	25	10	61123030	2,541
40IP	25	10	61123035	2,541



61126

PER VITI TORX-PLUS® IP

LAME 1/4" E PER VITI (IP) TORX-PLUS®

1/4" E POWER BITS FOR TORX-PLUS® SCREWS (IP)

58/60 HRC

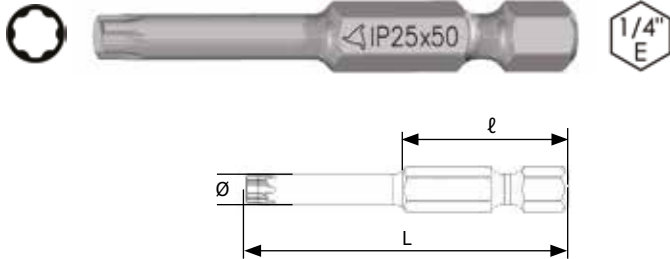

EASYPACK | sacchetto PVC con Euro-hole - PVC bags with Euro-hole

	L mm	l mm	Ø mm	PCS.	COD.	€ cad./each
6IP	50	25	3	5	611260001	5,500
	70	25	3	5	611260002	8,600
	90	25	3	5	611260003	10,000
8IP	50	25	3	5	611260001	5,500
	70	25	3	5	611260002	8,600
	90	25	3	5	611260003	10,000
10IP	50	25	4	5	611260005	5,519
	70	25	4	5	611260006	8,600
	90	25	4	5	611260007	10,000
	150	25	4	5	611260008	16,000
15IP	50	25	4	5	61126010	5,519
	70	25	4	5	61126011	8,600
	90	25	4	5	61126012	10,000
	150	25	4	5	61126013	16,000
20IP	50	25	5	5	61126015	5,519
	70	25	5	5	61126016	8,600
	90	25	5	5	61126017	10,000
	150	25	5	5	61126018	16,000
25IP	50	25	5	5	61126020	5,519
	70	25	5	5	61126021	8,600
	90	25	5	5	61126022	10,000
	150	25	5	5	61126023	16,000
27IP	50	25	6	5	61126025	5,519
	50	25	6	5	61126030	5,519
	70	25	6	5	61126031	8,600
30IP	90	25	6	5	61126032	10,000
	150	25	6	5	61126033	16,000
	50	25	1/4	5	61126035	5,519
40IP	70	25		5	61126036	8,600



FOCUS ON



Le viti TORX-PLUS® IP nasce come evoluzione dell'impronta TORX® tradizionale per garantire un'elevata resistenza alla coppia di torsione. Questo tipo di impronta viene utilizzata in campo meccanico e per il serraggio degli utensili da tornio.

TORX-PLUS® IPR screws are widely used in the field of mechanical assemblies. Their special shape ensures almost absolute inviolability.



1.2 LINEE ESSENTIAL

ESSENTIAL LINES

61001

ESAGONO

INSERTI 1/4" C ESAGONALI
1/4" C HEXAGONAL BITS

58/60 HRC

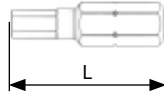

EASYPACK | sacchetto PVC con Euro-hole - PVC bags with Euro-hole

Ø	L mm	PCS.	COD.	€ cad./each
1,5	25	10	61001005	1,322
2	25	10	61001010	1,322
2,5	25	10	61001015	1,322
3	25	10	61001020	1,322
4	25	10	61001025	1,322
5	25	10	61001030	1,322
6	25	10	61001035	1,322
7	25	10	61001040	2,016
8	25	10	61001045	2,016
10	25	10	61001050	2,464

Ø	L mm	COD.	€ box
1,5	25	61001005002	4,144
2	25	61001010002	4,144
2,5	25	61001015002	4,144
3	25	61001020002	4,144
4	25	61001025002	4,144
5	25	61001030002	4,144
6	25	61001035002	4,144
7	25	61001040002	6,899
8	25	61001045002	6,899
10	25	61001050002	10,416



SELPACK
2 pcs.

Ø	L mm	COD.	€ box
1,5	25	61001005010	13,882
2	25	61001010010	13,882
2,5	25	61001015010	13,882
3	25	61001020010	13,882
4	25	61001025010	13,882
5	25	61001030010	13,882
6	25	61001035010	13,882
7	25	61001040010	21,210
8	25	61001045010	21,210
10	25	61001050010	25,825

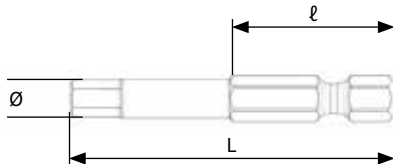

MINIBOX
10 pcs.

**61006****ESAGONO****LAME 1/4"E ESAGONALI****1/4"E HEXAGONAL POWER BITS****58/60 HRC****EASYPACK** | sacchetto PVC con Euro-hole - PVC bags with Euro-hole

Ø	L mm	ℓ mm	Ø mm	PCS.	COD.	€ cad./each
1,5	50	25	3	5	61006100	2,498
	70	25	3	5	61006105	7,198
2	50	25	3	5	61006005	2,632
	70	25	3	5	61006010	3,472
2,5	50	25	3,5	5	61006015	2,632
	70	25	4	5	61006020	3,472
	100	25	4	5	61006025	6,835
3	150	25	4	5	61006115	11,110
	50	25	4	5	61006030	2,632
	70	25	4	5	61006035	3,472
3	100	25	4	5	61006040	6,835
	127	25	4	5	61006120	8,879
	150	25	4	5	61006125	11,110
4	50	25	5	5	61006045	2,632
	70	25	5	5	61006050	3,472
	100	25	5	5	61006055	6,835
	127	25	5	5	61006130	8,879
4	150	25	5	5	61006135	11,110
	180	25	5	5	61006140	19,264
	50	25	6	5	61006060	2,632
	70	25	6	5	61006065	3,472
5	100	25	6	5	61006070	6,835
	127	25	6	5	61006150	8,879
	150	25	6	5	61006155	11,110
	180	25	6	5	61006157	19,264
6	50	25	1/4	5	61006075	2,632
	70	25	1/4	5	61006080	3,472
	100	25	1/4	5	61006085	6,835
	127	25	1/4	5	61006165	8,879
	150	25	1/4	5	61006170	11,110
6	180	25	1/4	5	61006175	19,264
	50	25	8	5	61006185	3,304
	70	25	8	5	61006190	5,858
8	50	25	5/16	5	61006090	3,304
	70	25	5/16	5	61006095	5,858
10	50	25	10	5	61006200	4,200
	70	25	10	5	61006205	12,096

1.2**SELFPACK**
2 pcs.

Ø	L mm	COD.	€ box
2,5	50	61006015002	6,754
3	50	61006030002	6,754
4	50	61006045002	6,754
5	50	61006060002	6,754
6	50	61006075002	6,754
8	50	61006090002	8,098

**MINIBOX**
5 pcs.

Ø	L mm	COD.	€ box
2,5	50	61006015005	13,818
3	50	61006030005	13,818
4	50	61006045005	13,818
5	50	61006060005	13,818
6	50	61006075005	13,818
8	50	61006090005	17,346



1.2 LINEE ESSENTIAL

ESSENTIAL LINES

61004

ESAGONO SFERICO

INSERTI 1/4" C ESAGONALI IMPRONTA TIPO SFERICO
1/4" C HEXAGONAL BALL TIP BITS

58/60 HRC

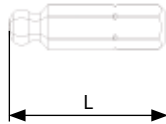

EASYPACK | sacchetto PVC con Euro-hole • PVC bags with Euro-hole

Ø	L mm	Ø mm	PCS.	COD.	€ cad./each
3	25		10	61004005	2,979
4	25		10	61004010	2,979
5	25		10	61004015	2,979
6	25		10	61004020	2,979



FOCUS ON

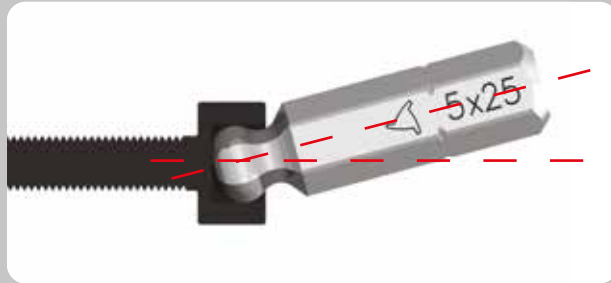

L'inserto tipo sferico permette di avvitare in posizione non rettilinea o disagiata. L'inclinazione massima di lavoro è 15°.

The ball-type bit allows screwing in a crooked or awkward position. The maximum working slope is 15°.

61007

ESAGONO SFERICO

LAME 1/4" E ESAGONALI IMPRONTA TIPO SFERICO
1/4" E HEXAGONAL POWER BALL TIP BITS

58/60 HRC

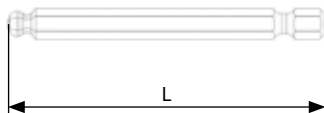

EASYPACK | sacchetto PVC con Euro-hole • PVC bags with Euro-hole

Ø	L mm	PCS.	COD.	€ cad./each
2	75	5	61007005	5,970
2,5	75	5	61007010	5,970
3	75	5	61007015	5,970
	150	5	61007035	17,248
4	75	5	61007020	5,970
	160	5	61007040	17,248
5	75	5	61007025	5,970
	150	5	61007045	17,248
6	75	5	61007030	5,970
	150	5	61007050	17,248



61002

ESAGONO CON FORO

INSERTI 1/4" C ESAGONALI ANTI-MANOMISSIONE
 1/4" C HEXAGONAL TAMPER-RESISTANT BITS

58/60 HRC

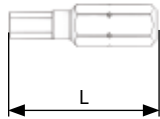

EASYPACK | sacchetto PVC con Euro-hole - PVC bags with Euro-hole

Ø	L mm	PCS.	COD.	€ cad./each
2	25	10	61002004	2,164
2,5	25	10	61002005	2,164
3	25	10	61002010	2,164
4	25	10	61002015	2,164
5	25	10	61002020	2,164
6	25	10	61002025	2,164

1.2

61003

ESAGONO (POLLICI)

INSERTI 1/4" C ESAGONALI MISURE IN POLLICI
 1/4" C HEXAGONAL BITS MEASUREMENTS INCHES SIZES

58/60 HRC

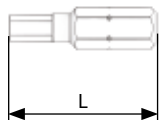

EASYPACK | sacchetto PVC con Euro-hole - PVC bags with Euro-hole

Ø	L mm	Ø mm	PCS.	COD.	€ cad./each
1/16"	25	1,58	10	61003005	2,229
1/8"	25	3,17	10	61003010	2,229
5/32"	25	3,97	10	61003015	2,229
3/16"	25	4,76	10	61003020	2,229
7/32"	25	5,55	10	61003025	2,229
1/4"	25	6,35	10	61003030	2,229



1.2 LINEE ESSENTIAL

ESSENTIAL LINES

61021

TAGLIO

INSERTI 1/4" C A TAGLIO

1/4" C SLOTTED BITS

57/60 HRC

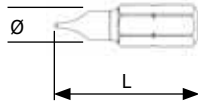

EASYPACK | sacchetto PVC con Euro-hole - PVC bags with Euro-hole

	Ø mm	L mm	PCS.	COD.	€ cad./each
0,5	3	25	10	61021005	1,232
0,6	3,5	25	10	61021010	1,232
0,6	4	25	10	61021015	1,232
0,6	4,5	25	10	61021020	1,232
0,8	5	25	10	61021025	1,232
0,8	5,5	25	10	61021035	1,232
1	5,5	25	10	61021030	1,232
1	6	25	10	61021040	1,232
1,2	6,5	25	10	61021045	1,232
1,2	8	25	10	61021050	2,195
1,6	8	25	10	61021054	2,195

	Ø mm	L mm	COD.	€ box
0,5	3	25	61021005002	3,965
0,6	3,5	25	61021010002	3,965
0,6	4	25	61021015002	3,965
0,6	4,5	25	61021020002	3,965
0,8	5	25	61021025002	3,965
0,8	5,5	25	61021035002	3,965
1,2	6,5	25	61021045002	3,965
1,2	8	25	61021050002	5,880
1,6	8	25	61021054002	5,880



SELPACK
2 pcs.

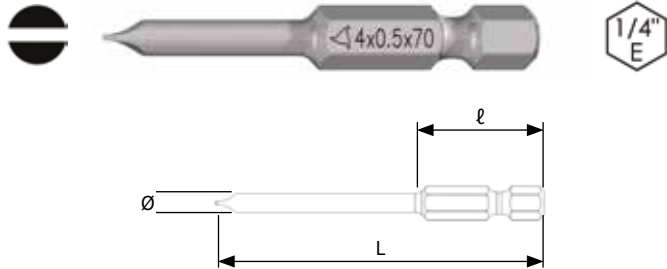

MINIBOX
10 pcs.

**61023****TAGLIO****LAME 1/4"E A TAGLIO**
1/4"E SLOTTED POWER BITS**57/60 HRC****EASYPACK** | sacchetto PVC con Euro-hole - PVC bags with Euro-hole

Ø mm	L mm	ℓ mm	PCS.	COD.	€ cad./each	
0,5	3	50	25	5	61023005	3,158
	3	70	25	5	61023010	5,107
0,6	3,5	50	25	5	61023015	3,158
	3,5	70	25	5	61023020	5,107
0,5	4	50	25	5	61023025	3,158
	4	70	25	5	61023030	5,107
0,6	4	100	25	5	61023115	9,598
	4,5	50	25	5	61023035	3,158
	4,5	70	25	5	61023040	5,107
0,8	4,5	100	25	5	61023120	9,598
	5	50	25	5	61023045	3,158
	5	70	25	5	61023050	5,107
0,8	5	100	25	5	61023125	9,598
	5,5	50	25	5	61023055	3,158
	5,5	70	25	5	61023060	5,107
1	6	50	25	5	61023065	3,158
	6	70	25	5	61023070	5,107
	6	100	25	5	61023130	9,598
1,2	6,5	50	25	5	61023075	3,158
	6,5	70	25	5	61023080	5,107
1,2	8	50	25	5	61023085	3,842
	8	70	25	5	61023090	6,574

Ø mm	L mm	COD.	€ box	
0,5	3	50	61023005002	7,806
0,6	3,5	50	61023015002	7,806
0,5	4	50	61023025002	7,806
0,6	4,5	50	61023035002	7,806
0,8	5	50	61023045002	7,806
0,8	5,5	50	61023055002	7,806
1,2	6,5	50	61023075002	7,806
1,2	8	50	61023085002	9,184

Ø mm	L mm	COD.	€ box	
0,5	3	50	61023005005	16,580
0,6	3,5	50	61023015005	16,580
0,5	4	50	61023025005	16,580
0,6	4,5	50	61023035005	16,580
0,8	5	50	61023045005	16,580
0,8	5,5	50	61023055005	16,580
1,2	6,5	50	61023075005	16,580
1,2	8	50	61023085005	20,171

**SELFPACK**
2 pcs.**MINIBOX**
5 pcs.



1.2 LINEE ESSENTIAL

ESSENTIAL LINES

61022

TAGLIO PER BUSSOLE GUIDA

INSERTI 1/4" C A TAGLIO TIPO LUNGO PER BUSSOLE GUIDA

1/4" C LONG SLOTTED BITS FOR FINDER SLEEVES

58/60 HRC

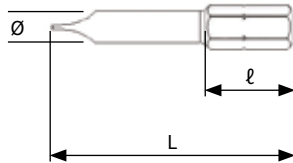

EASYPACK | sacchetto PVC con Euro-hole - PVC bags with Euro-hole

Ø mm	L mm	ℓ mm	PCS.	COD.	€ cad./each	
0,5	3	39	12	5	61022005	2,699
0,5	4	39	12	5	61022015	2,699
0,6	3,5	39	12	5	61022010	2,699
0,6	4,5	39	12	5	61022020	2,699
0,8	5	39	12	5	61022025	2,699
0,8	5,5	39	12	5	61022030	2,699
1	6	39	12	5	61022035	2,699
1,2	6,5	39	12	5	61022040	2,699
1,2	7,5	39	12	5	61022045	4,054
1,2	8	39	12	5	61022050	4,054
1,6	8,5	39	12	5	61022055	4,469
1,6	9	39	12	5	61022060	5,398

61025

BUSSOLE GUIDA

BUSSOLE GUIDA PER VITI A TAGLIO

FINDER SLEEVES FOR SLOTTED SCREWS

58/60 HRC

Ø



EASYPACK | sacchetto PVC con Euro-hole - PVC bags with Euro-hole

Ø	L mm	Ø mm ₁	PCS.	COD.	€ cad./each
3	47	4,1	1	61025005	48,048
3,5	47	4,6	1	61025010	48,048
4	47	5,1	1	61025015	48,048
4,5	47	5,6	1	61025020	48,048
5	47	6,1	1	61025025	48,048
5,5	47	6,6	1	61025030	48,048
6	47	7,1	1	61025035	48,048
6,5	47	7,6	1	61025040	48,048
7	47	8,1	1	61025045	48,048
7,5	47	8,6	1	61025050	48,048
8	47	9,1	1	61025055	48,048
8,5	47	9,6	1	61025060	48,048
9	47	10,1	1	61025065	48,048



FOCUS ON



Queste bussole evitano che la vite a taglio scappi dalla lama durante l'avvitatura e sono appositamente disegnate per essere utilizzate con inserti COD. 61022 e portainseriti COD. 62012 o COD. 62014.

These sockets prevent the slotted screw from coming out of the blade during screwing. They are specifically designed to be used with bits, code 61022 and bit holders, code 62012 or code 62014.



FOCUS ON



PHILLIPS®

Phillips® è un marchio registrato di PHILLIPS SCREW COMPANY, fondata da Hensy F. Phillips nel 1934 e cominciò ad essere largamente utilizzata nel 1940 dalla General Motors per l'assemblaggio delle Cadillac. La sua caratteristica principale sta nell'essere autocentrante, è quindi particolarmente indicata negli assemblaggi industriali su linee automatizzate.

Phillips® is a registered trademark of PHILLIPS SCREW COMPANY, which was founded by Henry F. Phillips in 1934. The Phillips screw began to be widely used in 1940 by General Motors for the assembly of the Cadillac. Its self-centring feature makes it particularly suitable for automatic assembly lines.



POZIDRIV®

POZIDRIV® è un marchio registrato di PHILLIPS SCREW COMPANY e venne sviluppato agli inizi degli anni '60. Si differenzia dall'impronta PHILLIPS® per avere una doppia serie di creste a croce; le creste principali hanno spessore costante che evita l'effetto di Come-Out. POZIDRIV® trova maggior impiego nel settore del legno.

POZIDRIV® is a registered trademark of PHILLIPS SCREW COMPANY and was developed in the early sixties. Unlike the PHILLIPS® tip, it has two series of cross-shaped ridges; the main ridges have a constant thickness that minimises the come-out effect. POZIDRIV® is widely used in the wood and timber industry.



TORX®

TORX® è un marchio registrato di ACCUMENT GLOBAL TECHNOLOGIES e brevettato nel 1967 da Camcar Textron. TORX® sopporta coppie più elevate rispetto alle viti PH a parità di dimensioni. Ha largo utilizzo in campo automotive. Le sue varianti sono: con foro (TXH), Torx Align® (conico, TW), Torx Plus® (IP), Torx Plus® con foro (IPR).

TORX® is a registered trademark of ACCUMENT GLOBAL TECHNOLOGIES and was patented by Camcar Textron in 1967. TORX® supports higher torques than PH screws of the same size. It is widely used in the automotive industry. It comes in the following versions: with slot (TXH), Torx Align® (tapered, TW), Torx Plus® (IP), Torx Plus® with slot (IPR).



ESAGONO

La vite con cava esagonale, inventata da Mr. W.G. Allen (1910), prende il nome italiano dalle Officine Egidio Brugola di Lissone che per prime la produssero e distribuirono in Italia. È utilizzata su viti con filettatura metrica ed impiegata principalmente in ambito meccanico, automotive e/o carpenteria metallica.

The hex socket screw was invented by W.G. Allen in 1910, the Italian name comes from the founder of the Officine Egidio Brugola of Lissone who first produced and marketed it in Italy. It is used on screws with metric thread, mainly in the mechanical, automotive and/or metal carpentry industries.



TAGLIO

Le prime tracce di viti con intaglio risalgono al tardo Medioevo. Le prime documentazioni si trovano nel Housebook medievale del castello di Wolfegg in Germania, in un manoscritto del 1490. Vengono oggi utilizzate soprattutto in ambito elettrico ed elettronico.

The first traces of slotted head screws date back to the late medieval period. Documentation was found in the Medieval Housebook of the castle of Wolfegg - Germany, a manuscript of 1490. Today, they are used mainly for electrical and electronic applications.





1.2 LINEE ESSENTIAL

ESSENTIAL LINES

61029

PLUS/MINUS TAGLIO + PH

INSERTI 1/4" C IMPRONTA COMBINATA TAGLIO / PH

1/4" C BITS COMBINED SLOTTED / PH TIP

57/60 HRC

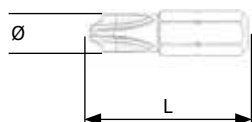

EASYPACK | sacchetto PVC con Euro-hole - PVC bags with Euro-hole

	L mm	PCS.	COD.	€ cad./each
PH1	25	10	61029005	2,408
PH2	25	10	61029010	2,408
PH3	25	10	61029015	2,408



	L mm	COD.	€ box
PH1	25	61029005002	6,306
PH2	25	61029010002	6,306
PH3	25	61029015002	6,306

SELFPACK
2 pcs.



	L mm	COD.	€ box
PH1	25	61029005010	25,284
PH2	25	61029010010	25,284
PH3	25	61029015010	25,284

MINIBOX
10 pcs.

61029

PLUS/MINUS TAGLIO + PH

LAME 1/4" E IMPRONTA COMBINATA TAGLIO / PH

1/4" E POWER BITS COMBINED SLOTTED / PH TIP

57/60 HRC

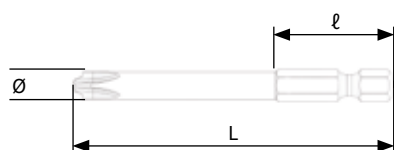

EASYPACK | sacchetto PVC con Euro-hole - PVC bags with Euro-hole

	L mm	ℓ mm	PCS.	COD.	€ cad./each
PH1	70	25	5	61029105	6,306
PH2	70	25	5	61029110	6,306
PH3	70	25	5	61029115	6,306



	L mm	COD.	€ box
PH1	70	61029105002	14,112
PH2	70	61029110002	14,112
PH3	70	61029115002	14,112

SELFPACK
2 pcs.



	L mm	COD.	€ box
PH1	70	61029105005	33,107
PH2	70	61029110005	33,107
PH3	70	61029115005	33,107

MINIBOX
5 pcs.



61030

PLUS/MINUS TAGLIO + PZ

INSERTI 1/4" C IMPRONTA COMBINATA TAGLIO / PZ
 1/4" C BITS COMBINED SLOTTED / PZ TIP

57/60 HRC

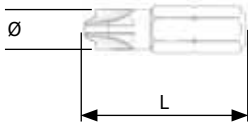

EASYPACK | sacchetto PVC con Euro-hole - PVC bags with Euro-hole

	L mm	PCS.	COD.	€ cad./each
PZ1	25	10	61030005	2,408
PZ2	25	10	61030010	2,408
PZ3	25	10	61030015	2,408



SELPACK
2 pcs.

	L mm	COD.	€ box
PZ1	25	61030005002	6,306
PZ2	25	61030010002	6,306
PZ3	25	61030015002	6,306



MINIBOX
10 pcs.

	L mm	COD.	€ box
PZ1	25	61030005010	25,284
PZ2	25	61030010010	25,284
PZ3	25	61030015010	25,284

61030

PLUS/MINUS TAGLIO + PZ

LAME 1/4" E IMPRONTA COMBINATA TAGLIO / PZ
 1/4" E POWER BITS COMBINED SLOTTED / PZ TIP

57/60 HRC

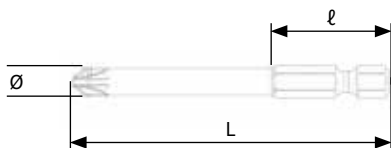

EASYPACK | sacchetto PVC con Euro-hole - PVC bags with Euro-hole

	L mm	ℓ mm	PCS.	COD.	€ cad./each
PZ1	70	25	5	61030105	6,306
PZ2	70	25	5	61030110	6,306
PZ3	70	25	5	61030115	6,306



SELPACK
2 pcs.

	L mm	COD.	€ box
PZ1	70	61030105002	14,112
PZ2	70	61030110002	14,112
PZ3	70	61030115002	14,112



MINIBOX
5 pcs.

	L mm	COD.	€ box
PZ1	70	61030105005	33,107
PZ2	70	61030110005	33,107
PZ3	70	61030115005	33,107



1.2 LINEE ESSENTIAL

ESSENTIAL LINES

61133

QUADRO

INSERTI 1/4" C IMPRONTA QUADRA
1/4" C BITS SQUARE TIP

58/60 HRC

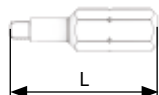
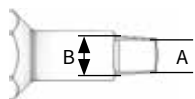

EASYPACK | sacchetto PVC con Euro-hole - PVC bags with Euro-hole

Ø	L mm	A	B	PCS.	COD.	€ cad./each
1 3/32"	25	2,31	2,5	10	61133005	1,053
2 1/8"	25	2,85	3,2	10	61133010	1,053
3 9/64"	25	3,37	3,7	10	61133015	1,053

61134

QUADRO

LAME 1/4" E IMPRONTA QUADRA
1/4" E POWER BITS SQUARE TIP

58/60 HRC

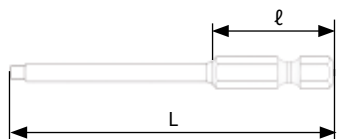
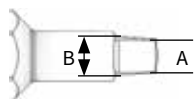

EASYPACK | sacchetto PVC con Euro-hole - PVC bags with Euro-hole

Ø	L mm	ℓ mm	A	B	PCS.	COD.	€ cad./each
1 3/32"	70	25	2,31	2,5	5	61134005	3,002
2 1/8"	70	25	2,85	3,2	5	61134010	3,002
3 9/64"	70	25	3,37	3,7	5	61134015	3,002



61122

SPANNER

INSERTI 1/4" C PER VITI SPANNER
1/4" C BITS FOR SPANNER SCREWS

57/60 HRC

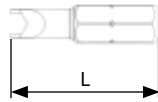
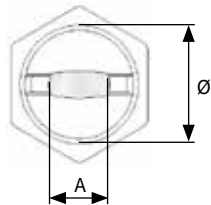



EASYPACK | sacchetto PVC con Euro-hole - PVC bags with Euro-hole

●	L mm	Ø mm	A	PCS.	COD.	€ cad./each
4	25	3,7	1,50	10	61122005	1,960
6	25	4,4	2,40	10	61122010	1,960
8	25	4,9	2,80	10	61122015	1,960
10	25	6,1	3,30	10	61122020	1,960

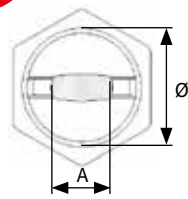

TIPS



●	Ø	A	
4	3,7	1,50	2,5x0,45
6	4,4	2,40	3,0x0,5
8	4,9	2,80	4,0x0,7
10	6,1	3,30	5,0x0,8

61135

SPANNER

LAME 1/4" E PER VITI SPANNER
1/4" E POWER BITS FOR SPANNER SCREWS

57/60 HRC

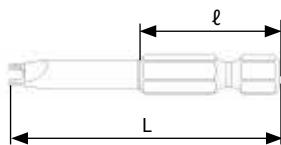
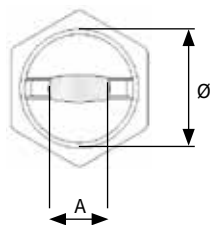



EASYPACK | sacchetto PVC con Euro-hole - PVC bags with Euro-hole

●	L mm	ℓ mm	Ø mm	A	PCS.	COD.	€ cad./each
4	50	25	3,7	1,50	5	61135005	4,771
6	50	25	4,4	2,40	5	61135010	4,771
8	50	25	4,9	2,80	5	61135015	4,771
10	50	25	6,1	3,30	5	61135020	4,771

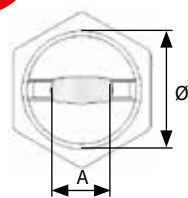

TIPS



●	Ø	A	
4	3,7	1,50	2,5x0,45
6	4,4	2,40	3,0x0,5
8	4,9	2,80	4,0x0,7
10	6,1	3,30	5,0x0,8



1.2 LINEE ESSENTIAL

ESSENTIAL LINES

61125

TRI-WING®

INSERTI 1/4" C PER VITI TRI-WING®
1/4" C BITS FOR TRI-WING® SCREWS

57/60 HRC

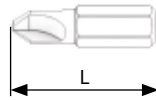
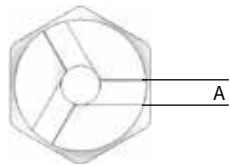

EASYPACK | sacchetto PVC con Euro-hole - PVC bags with Euro-hole

	L mm	A	PCS.	COD.	€ cad./each
1	25	0,6	10	61125005	2,106
2	25	0,75	10	61125010	2,106
3	25	0,95	10	61125015	2,106
4	25	1,1	10	61125020	2,106

61137

TRI-WING®

LAME 1/4" E PER VITI TRI-WING®
1/4" E POWER BITS FOR TRI-WING® SCREWS

57/60 HRC

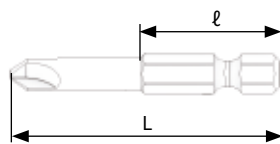
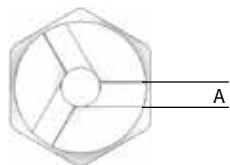

EASYPACK | sacchetto PVC con Euro-hole - PVC bags with Euro-hole

	L mm	l mm	A	PCS.	COD.	€ cad./each
1	50	25	0,6	5	61137005	4,861
2	50	25	0,75	5	61137010	4,861
3	50	25	0,95	5	61137015	4,861
4	50	25	1,1	5	61137020	4,861



61124

TORQ-SET®

INSERTI 1/4" C PER VITI TORQ-SET®
1/4" C BITS FOR TORQ-SET® SCREWS

57/60 HRC

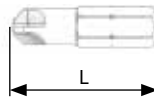
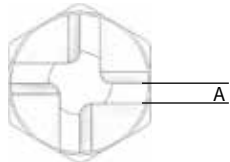

EASYPACK | sacchetto PVC con Euro-hole - PVC bags with Euro-hole

+	L mm	A	PCS.	COD.	€ cad./each
0	25	0,4	10	61124000	2,106
1	25	0,4	10	61124001	2,106
2	25	0,4	10	61124002	2,106
3	25	0,45	10	61124003	2,106
4	25	0,5	10	61124004	2,106
5	25	0,6	10	61124005	2,106
6	25	0,7	10	61124006	2,106
8	25	0,85	10	61124010	2,106
10	25	0,95	10	61124015	2,106
1/4"	25	1,25	10	61124020	2,834
5/16"	32	1,50	10	61124025	3,864

1.2

61136

TORQ-SET®

LAME 1/4" E PER VITI TORQ-SET®
1/4" E POWER BITS FOR TORQ-SET® SCREWS

57/60 HRC

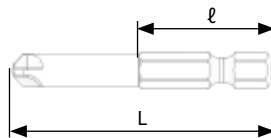
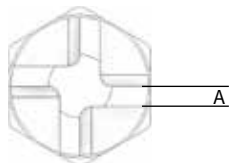

EASYPACK | sacchetto PVC con Euro-hole - PVC bags with Euro-hole

+	L mm	l mm	A	PCS.	COD.	€ cad./each
6	50	25	0,7	5	61136005	4,861
8	50	25	0,85	5	61136010	4,861
10	50	25	0,95	5	61136015	4,861

1.2 LINEE ESSENTIAL ESSENTIAL LINES

61132

XZN

INSERTI 1/4" C PER VITI XZN
1/4" C BITS FOR XZN SCREWS

57/60 HRC

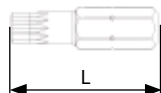
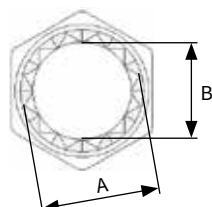

EASYPACK | sacchetto PVC con Euro-hole - PVC bags with Euro-hole

Ø	L mm	A	B	PCS.	COD.	€ cad./each
M4	25	3,80	3,10	10	61132005	1,803
M5	25	4,10	4,00	10	61132010	1,803
M6	25	6,00	5,00	10	61132015	1,803
M8	25	7,20	6,00	10	61132020	2,699
M10	25	9,60	8,00	10	61132025	2,699

61138

XZN

LAME 1/4" E PER VITI XZN
1/4" E POWER BITS FOR XZN SCREWS

57/60 HRC

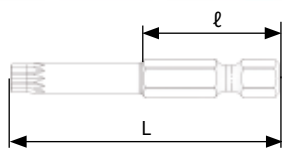
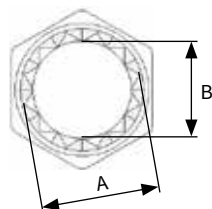

EASYPACK | sacchetto PVC con Euro-hole - PVC bags with Euro-hole

Ø	L mm	ℓ mm	A	B	PCS.	COD.	€ cad./each
M4	50	25	3,80	3,10	5	61138005	4,682
M5	50	25	4,10	4,00	5	61138010	4,682
M6	50	25	6,00	5,00	5	61138015	4,682
M8	50	25	7,20	6,00	5	61138020	4,682
M10	50	25	9,60	8,00	5	61138025	4,682



61147

ASSI-SIT

INSERTI 1/4" C PER VITI AW® ASSI-SIT
1/4" C BITS FOR AW® ASSI-SIT SCREWS

58/60 HRC

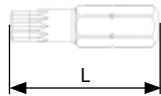

EASYPACK | sacchetto PVC con Euro-hole - PVC bags with Euro-hole

	L mm	PCS.	COD.	€ cad./each
AW10	25	10	61147005	2,128
AW15	25	10	61147010	2,128
AW20	25	10	61147015	2,128
AW25	25	10	61147020	2,128
AW30	25	10	61147025	2,128
AW40	25	10	61147030	2,128



Interno di un Hangar di fabbricazioni di aeromobili.
Interior of an aircraft manufacturing hangar.



1.2 LINEE ESSENTIAL ESSENTIAL LINES

61041

PH DOPPIO

LAME 1/4"E DOPPIA IMPRONTA PHILLIPS®
1/4"E PHILLIPS® POWER BITS DOUBLE TIP

58/60 HRC

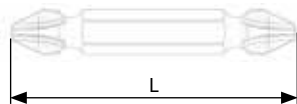

EASYPACK | sacchetto PVC con Euro-hole - PVC bags with Euro-hole

	L mm	PCS.	COD.	€ cad./each
1 x 1	45	5	61041005	2,554
1 x 1	75	5	61041010	2,856
2 x 2	45	5	61041015	2,554
2 x 2	75	5	61041020	2,856
3 x 3	75	5	61041025	2,856

61067

PZ DOPPIO

LAME 1/4"E DOPPIA IMPRONTA POZIDRIV®
1/4"E POZIDRIV® POWER BITS DOUBLE TIP

58/60 HRC

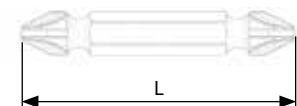
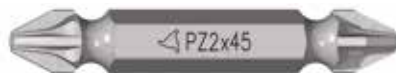

EASYPACK | sacchetto PVC con Euro-hole - PVC bags with Euro-hole

	L mm	PCS.	COD.	€ cad./each
1 x 1	45	5	61067005	4,626
1 x 1	75	5	61067010	4,950
2 x 2	45	5	61067015	4,626
2 x 2	75	5	61067020	4,950



61027

DOPPIO TAGLIO + PH

INSERTI 1/4" DOPPIA IMPRONTA TAGLIO + PH
1/4" BITS DOUBLE SLOTTED + PH TIP

57/60 HRC

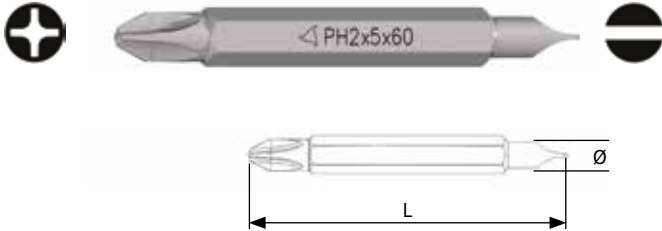

EASYPACK | sacchetto PVC con Euro-hole - PVC bags with Euro-hole

+	L mm	Ø	PCS.	COD.	€ cad./each
PH1	60	0,6x4,0	10	61027005	2,251
PH2	60	0,8x5,0	10	61027010	2,251
PH3	60	1,2x7,0	10	61027015	2,251

1.2



SELFPACK
2 pcs.

+	L mm	COD.	€ box
PH1	60	61027005002	6,003
PH2	60	61027010002	6,003
PH3	60	61027015002	6,003



MINIBOX
5 pcs.

+	L mm	COD.	€ box
PH1	60	61027005005	11,818
PH2	60	61027010005	11,818
PH3	60	61027015005	11,818

61028

DOPPIO TAGLIO + PZ

INSERTI 1/4" DOPPIA IMPRONTA TAGLIO + PZ
1/4" BITS DOUBLE SLOTTED + PZ TIP

57/60 HRC

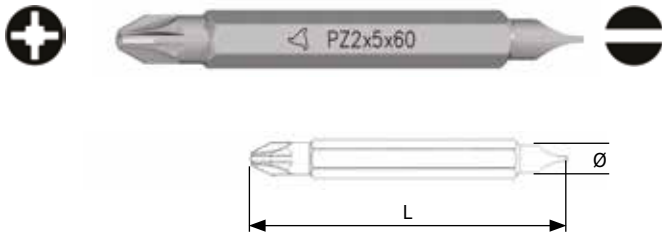

EASYPACK | sacchetto PVC con Euro-hole - PVC bags with Euro-hole

+	L mm	Ø	PCS.	COD.	€ cad./each
PZ1	60	0,6x4,0	10	61028005	2,251
PZ2	60	0,8x5,0	10	61028010	2,251
PZ3	60	1,2x7,0	10	61028015	2,251



SELFPACK
2 pcs.

+	L mm	COD.	€ box
PZ1	60	61028005002	6,003
PZ2	60	61028010002	6,003
PZ3	60	61028015002	6,003



MINIBOX
5 pcs.

+	L mm	COD.	€ box
PZ1	60	61028005005	11,818
PZ2	60	61028010005	11,818
PZ3	60	61028015005	11,818



1.2 LINEE ESSENTIAL

ESSENTIAL LINES

66002

MYBIT 7 ASSORTIMENTI ESSENTIAL

ASSORTIMENTO 7 PCS. - INSERTI + PORTAINSERTI
7 PCS. SET - BITS + BIT-HOLDER



7
pcs.

INCLUSO INCLUDED
 COD. 62013005



INCLUSO INCLUDED
 COD. 62015010









100 X 120 mm



INCLUSO/INCLUDED COD. 62013005 COD. **66002105**
 € 13,306

61043 		61069 		61021 	
PH1	PH2	PZ1	PZ2	0,6x4,5	1,2x6,5
1pc.	1pc.	1pc.	1pc.	1pc.	1pc.

INCLUSO/INCLUDED COD. 62015010 COD. **66002170**
 € 15,987

61001 					
2	2,5	3	4	5	6
1pc.	1pc.	1pc.	1pc.	1pc.	1pc.



INCLUSO/INCLUDED COD. 62013005 COD. **66002115**
 € 13,877

61094 					
TX10	TX15	TX20	TX25	TX30	TX40
1pc.	1pc.	1pc.	1pc.	1pc.	1pc.

INCLUSO/INCLUDED COD. 62013005 COD. **66002155**
 € 22,042

61123 					
IP10	IP15	IP20	IP25	IP30	IP40
1pc.	1pc.	1pc.	1pc.	1pc.	1pc.

INCLUSO/INCLUDED COD. 62013005 COD. **66002125**
 € 12,818

61043 		61069 		61094 	
PH1	PH2	PZ1	PZ2	TX25	TX30
1pc.	1pc.	1pc.	1pc.	1pc.	1pc.

INCLUSO/INCLUDED COD. 62013005 COD. **66002160**
 € 21,874

61121 					
10	15	20	25	30	40
1pc.	1pc.	1pc.	1pc.	1pc.	1pc.

INCLUSO/INCLUDED COD. 62013005 COD. **66002150**
 € 17,976

61111 					
TXH10	TXH15	TXH20	TXH25	TXH30	TXH40
1pc.	1pc.	1pc.	1pc.	1pc.	1pc.

INCLUSO/INCLUDED COD. 62013005 COD. **66002165**
 € 19,354

61132 				
M4	M5	M6	M8	M10
1pc.	2pcs.	1pc.	1pc.	1pc.



66002

DISPLAY MYBIT 7 ESSENTIAL

ESPOSITORE DA BANCO PER 12 BIT-SETS
12 PCS. BIT-SETS DISPLAY



150 X 40 X 195 mm

12
pcs.

COD. **66002108**
€ 152,410



12 pcs.
COD. 66002105

COD. **66002118**
€ 158,592



12 pcs.
COD. 66002115

COD. **66002129**
€ 146,496



12 pcs.
COD. 66002125

1.2

66007

MYBIT 7 POWER ESSENTIAL

ASSORTIMENTO 7 PCS. - INSERTI
7 PCS. SET - BITS



100 X 120 mm

7
pcs.

COD. **66007100**
€ 17,297

61051 L=50mm		61076 L=50mm		61079 L=50mm		
PH1 1pc.	PH2 1pc.	PZ1 1pc.	PZ2 1pc.	TX25 1pc.	TX30 1pc.	TX40 1pc.

COD. **66007105**
€ 12,920

61051 L=50mm			61076 L=50mm		
PH1 1pc.	PH2 2pcs.	PH3 1pc.	PZ1 1pc.	PZ2 1pc.	PZ3 1pc.



1.2 LINEE ESSENTIAL

ESSENTIAL LINES

66005

MYBIT10 ASSORTIMENTI ESSENTIAL

ASSORTIMENTO 10 PCS. - INSERTI + PORTAINSERTI

10 PCS. SET - BITS + BIT-HOLDER



10 pcs.



100 X 120 mm



COD. **66005105**
€ 14,927

COD. **66005170**
€ 19,318

61043			61069			61021		
PH1	PH2	PH3	PZ1	PZ2	PZ3	0,6x4,5	1,0x5,5	1,2x6,5
1pc.	1pc.	1pc.	1pc.	1pc.	1pc.	1pc.	1pc.	1pc.

61001						
2	2,5	3	4	5	6	8
1pc.	1pc.	1pc.	2pcs.	2pcs.	1pc.	1pc.

COD. **66005115**
€ 13,759

COD. **66005155**
€ 22,814

61043			61069			61094		
PH1	PH2	PH3	PZ1	PZ2	PZ3	TX25	TX30	TX40
1pc.	1pc.	1pc.	1pc.	1pc.	1pc.	1pc.	1pc.	1pc.

61111						
TXH09	TXH10	TXH15	TXH20	TXH25	TXH30	TXH40
1pc.	1pc.	1pc.	2pcs.	2pcs.	1pc.	1pc.

COD. **66005125**
€ 15,314

COD. **66005160**
€ 29,149

61043		61069		61001		
PH1	PH2	PZ1	PZ2	3	4	5
1pc.	2pc.	1pc.	2pc.	1pc.	1pc.	1pc.

61123					
IP10	IP15	IP20	IP25	IP30	IP40
1pc.	2pcs.	2pcs.	2pcs.	1pc.	1pc.

COD. **66005150**
€ 16,897

COD. **66005165**
€ 29,635

61094								
TX06	TX08	TX09	TX10	TX15	TX20	TX25	TX30	TX40
1pc.	1pc.	1pc.	1pc.	1pc.	1pc.	1pc.	1pc.	1pc.

61121							
10	15	20	25	27	30	40	
1pc.	1pc.	2pcs.	2pcs.	1pc.	1pc.	1pc.	



66005

DISPLAY MYBIT 10 ESSENTIAL

ESPOSITORE DA BANCO PER 12 BIT-SETS
12 PCS. BIT-SETS DISPLAY



150 X 40 X 195 mm

12
pcs.

COD. **66005109**
€ 171,132



12 pcs.
COD. 66005105

COD. **66005119**
€ 157,248



12 pcs.
COD. 66005115

COD. **66005129**
€ 174,008



12 pcs.
COD. 66005125

COD. **66005154**
€ 193,294



12 pcs.
COD. 66005150

1.2



1.2 LINEE ESSENTIAL

ESSENTIAL LINES

66006

MYBIT15 ASSORTIMENTI ESSENTIAL

ASSORTIMENTO 15 PCS. - INSERTI + PORTAINSERITI

15 PCS. SET - BITS + BIT-HOLDER

15
pcs.



100 X 167 mm



INCLUSO
INCLUDED



COD. 62013005

COD. **66006020**

€ 19,964

 61043			 61069			 61021		
PH1	PH2	PH3	PZ1	PZ2	PZ3	0,6x4,5	0,8x5,5	1,2x6,5
1pc.	1pc.	1pc.	1pc.	1pc.	1pc.	1pc.	1pc.	1pc.
 61094			 61051			 61076		
TX15	TX20	TX25	PH2x70			PZ2x70		
1pc.	1pc.	1pc.	1pc.			1pc.		

COD. **66006050**

€ 27,401

 61001					
2	2,5	3	4	5	6
1pc.	1pc.	1pc.	1pc.	1pc.	1pc.
 61111					
TXH10	TXH15	TXH20	TXH25	TXH30	TXH40
1pc.	1pc.	1pc.	1pc.	1pc.	1pc.
 61006					
4x70			5x70		
1pc.			1pc.		

COD. **66006055**

€ 45,259

 61123					
IP10	IP15	IP20	IP25	IP30	IP40
1pc.	1pc.	1pc.	1pc.	1pc.	1pc.
 61121					
10	15	20	25	30	40
1pc.	1pc.	1pc.	1pc.	1pc.	1pc.
 61126					
IP20x50			IP25x50		
1pc.			1pc.		

COD. **66006060**

€ 32,222

 61124				 61125			
06	08	10	1	2	3	4	
1pc.	1pc.	1pc.	1pc.	1pc.	1pc.	1pc.	
 61122				 61133			
4	6	8	10	3			
1pc.	1pc.	1pc.	1pc.	1pc.			
 61134							
1x70				2x70			
1pc.				1pc.			



66006

DISPLAY MYBIT 15 ESSENTIAL

ESPOSITORE DA BANCO PER 12 BIT-SETS
12 PCS. BIT-SETS DISPLAY



185 X 40 X 195 mm

12
pcs.

COD. **66006024**
€ 228,110



12 pcs.
COD. 66006020

COD. **66006054**
€ 313,152



12 pcs.
COD. 66006050

COD. **66006059**
€ 518,972



12 pcs.
COD. 66006055

COD. **66006064**
€ 368,256



12 pcs.
COD. 66006060

1.2 LINEE ESSENTIAL

ESSENTIAL LINES

66006

MYBIT 1/4 ESSENTIAL CON CRICCHETTO

ASSORTIMENTO 14 PCS. - INSERTI +PORTAINSERI E CRICCHETTO
 14 PCS. SET - BITS + BIT HOLDER AND RATCHET



14 pcs.

COD. **66006500**
 € 35,935

61043			61069		
PH1	PH2	PH3	PZ1	PZ2	PZ3
1pc.	1pc.	1pc.	1pc.	1pc.	1pc.
61021			61094		
4,5x0,6	5,5x0,8	6,5x1,2	TX25	TX30	TX40
1pc.	1pc.	1pc.	1pc.	1pc.	1pc.



100 X 170 mm



INCLUSO
 INCLUDED

COD. 62013005

COD. 64221030

66006

ASSORTIMENTI INSERTI 1/4" COLOUR

ASSORTIMENTO 15 PCS. INSERTI COLOUR CON PORTAINSERI MAGNETICO RAPIDO
 15 PCS. COLOUR BIT-SET WITH QUICK RELEASE MAGNETIC BIT-HOLDER



15 pcs.

COD. **66006006**
 € 15,288

PH1		PH2		PZ1		PZ2		TX10		TX15		TX20		TX30	
1pc.	1pc.	1pc.	1pc.	1pc.	1pc.	1pc.	1pc.	1pc.	1pc.	1pc.	1pc.	1pc.	1pc.	1pc.	1pc.
4,0x0,5				5,0x0,8		6,0x1,2		3		4		5			
1pc.	1pc.	1pc.	1pc.	1pc.	1pc.	1pc.	1pc.	1pc.	1pc.	1pc.	1pc.	1pc.	1pc.	1pc.	1pc.



75 X 145 mm

**66009**

ASSORTIMENTI INSERTI 1/4" + PORTAININSERTI SGANCIO RAPIDO

ASSORTIMENTO 32 PCS. INSERTI CON PORTAININSERTI A SGANCIO RAPIDO
32 PCS. BITS AND QUICK RELEASE BIT HOLDER SET

**32 pcs.**COD. **66009005**

€ 23,708

PH1	PH2	PH3	PZ1	PZ2	PZ3				
2pcs.	3pcs.	1pc.	2pcs.	3pcs.	1pc.				
3,0x0,5	4,5x0,6	5,5x0,8	6,5x1,2	2	2,5	3	4	5	6
1pc.	1pc.	1pc.	1pc.	1pc.	1pc.	1pc.	1pc.	1pc.	1pc.
TXH09	TXH10	TXH15	TXH20	TXH25	TXH27	TXH30	TXH40		
1pc.	1pc.	1pc.	1pc.	1pc.	1pc.	1pc.	1pc.		

INCLUSO
INCLUDED**66009**

DISPLAY 6 PCS.

ESPOSITORE DA BANCO 6 ASSORTIMENTI D'INSERTI
6 PCS. BITS SETS COUNTER DISPLAY

**6 pcs.**COD. **66009009**

€ 122,909

6 pcs.
COD. 66009005



1.2 LINEE ESSENTIAL

ESSENTIAL LINES

66009

ASSORTIMENTI INSERTI COLOUR 1/4" + PORTAININSERTI SGANCIO RAPIDO

ASSORTIMENTO 32 PCS. INSERTI CON PORTAININSERTI A SGANCIO RAPIDO
 32 PCS. BITS AND QUICK RELEASE BIT HOLDER SET



32 pcs.

COD. **66009015**

€ 27,458

PH1	PH2	PH3	PZ1	PZ2	PZ3	3x0,5	4x0,6	5x0,8	6x1	
1pc.	2pcs.	1pc.	1pc.	2pcs.	1pc.	1pc.	1pc.	2pcs.	1pc.	
3	4	5	6	TX10	TX15	TX20	TX25	TX27	TX30	TX40
1pc.	1pc.	1pc.	1pc.	1pc.	1pc.	1pc.	1pc.	1pc.	1pc.	1pc.
TXH10	TXH15	TXH20	TXH25	TXH27	TXH30	TXH40				
1pc.	1pc.	1pc.	1pc.	1pc.	1pc.	1pc.				

COLOUR RING



INCLUSO
INCLUDED



66009

DISPLAY 6 PCS.

ESPOSITORE DA BANCO 6 ASSORTIMENTI D'INSERTI
 6 PCS. BITS SETS COUNTER DISPLAY



6 pcs.

COD. **66009019**

€ 141,926

COLOUR RING



6 pcs.
COD. 66009015



66012

ASSORTIMENTI INSERTI E BUSSOLE 1/4" COLOUR + GIRAVITE A CRICCHETTO

ASSORTIMENTO 26 PCS. INSERTI, BUSSOLE ED ACCESSORI
26 PCS. BITS, SOCKETS AND ACCESSORIES



COLOUR RING



26
pcs.

COD. **66012006**

€ 21,050

PH1 1pc.	PH2 2pcs.	PH3 1pc.	PZ1 1pc.	PZ2 2pcs.	PZ3 1pc.			
1,3x0,5 1pc.	4,5x0,6 1pc.	5,5x0,8 1pc.	6,5x1,2 1pc.	TX10 1pc.	TX15 1pc.	TX20 1pc.	TX25 1pc.	TX30 1pc.
5 1pc.	6 1pc.	7 1pc.	8 1pc.	9 1pc.	10 1pc.			

INCLUSO
INCLUDED

REVERSIBILE

1.2



1.2 LINEE ESSENTIAL

ESSENTIAL LINES

66010

ASSORTIMENTI ESSENTIAL

ASSORTIMENTO 31 PCS. - INSERTI + PORTAINSERTI
 31 PCS. SET - BITS + BIT-HOLDER



80 X 115 X 30 mm

31
pcs.

COD. **66010005**

€ 35,162

61043



PH1 2pcs.	PH2 4pcs.	PH3 1pc.
--------------	--------------	-------------

61069

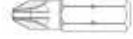

PZ1 2pcs.	PZ2 3pcs.	PZ3 1pc.
--------------	--------------	-------------

61021



0,5x3,0 1pc.	0,6x4,0 1pc.	0,8x5,5 1pc.	1,0x6,0 1pc.	1,2x8,0 1pc.
-----------------	-----------------	-----------------	-----------------	-----------------

61001



2,5 1pc.	3 1pc.	4 1pc.	5 1pc.	6 1pc.
-------------	-----------	-----------	-----------	-----------

61111



TXH10 1pc.	TXH15 1pc.	TXH20 1pc.	TXH25 1pc.	TXH27 1pc.	TXH30 1pc.	TXH40 1pc.
---------------	---------------	---------------	---------------	---------------	---------------	---------------

INCLUSO
INCLUDED

COD. 62013005



IL CONTENITORE È DOTATO INTERNAMENTE DI UNA BASE MAGNETICA CHE EVITA LA FUORIUSCITA ACCIDENTALE DEGLI INSERTI.
 THE INSIDE OF THE CONTAINER HAS A MAGNETIC BASE THAT PREVENTS THE BITS FROM ACCIDENTALLY FALLING OUT.

COD. **66010050**

€ 64,798

61124



06 1pc.	08 1pc.	10 1pc.
------------	------------	------------

61125



1 1pc.	2 1pc.	3 1pc.	4 1pc.
-----------	-----------	-----------	-----------

61122



4 1pc.	6 1pc.	8 1pc.	10 1pc.
-----------	-----------	-----------	------------

61132



4 1pc.	5 1pc.	6 1pc.	8 1pc.	10 1pc.
-----------	-----------	-----------	-----------	------------

61111



TXH10 1pc.	TXH15 1pc.	TXH20 2pcs.	TXH25 2pcs.	TXH27 1pc.	TXH30 1pc.	TXH40 1pc.
---------------	---------------	----------------	----------------	---------------	---------------	---------------

61121



15 1pc.	20 1pc.	25 1pc.	30 1pc.	40 1pc.
------------	------------	------------	------------	------------



66014

ASSORTIMENTI INSERTI 1/4" COLOUR

ASSORTIMENTO 42 PCS. INSERTI COLOUR CON PORTAINSERI MAGNETICO RAPIDO
42 PCS. COLOUR BIT-SET WITH QUICK RELEASE MAGNETIC BIT-HOLDER

42
pcs.

COD. **66014004**

€ 26,460



95 X 130 mm

PH1 3pcs.	PH2 3pcs.	PH3 3pcs.	PZ1 2pcs.	PZ2 2pcs.	PZ3 2pcs.		
4,0x0,5 2pcs.	5,0x0,8 1pc.	6,0x1,2 1pc.	3 1pc.	4 1pc.	5 1pc.		
TX10 1pc.	TX15 1pc.	TX20 1pc.	TX25 1pc.	TX27 1pc.	TX30 1pc.	TX40 1pc.	
TXH10 1pc.	TXH15 1pc.	TXH20 1pc.	TXH25 1pc.	TXH27 1pc.	TXH30 1pc.	TXH40 1pc.	
PH2 1pc.		PZ2 1pc.		TX20 1pc.		1 x 6 1pc.	

INCLUSO
INCLUDED

COD. 62019010

COD. 62100005



1.2 LINEE ESSENTIAL

ESSENTIAL LINES

66014

ASSORTIMENTI INSERTI 1/4" COLOUR

ASSORTIMENTO 71 PCS. INSERTI COLOUR CON PORTAININSERTI MAGNETICO RAPIDO
 71 PCS. COLOUR BIT-SET WITH QUICK RELEASE MAGNETIC BIT-HOLDER



120 X 160 mm

71 pcs.

COD. **66014006**

€ 41,642

PH1 3pcs.	PH2 6pcs.	PH3 3pcs.	PZ1 3pcs.	PZ2 6pcs.	PZ3 3pcs.		
4,0x0,6 3pcs.		6,0x1,2 3pcs.					
4 3pcs.			5 3pcs.				
6 3pcs.							
TX10 3pcs.	TX15 2pcs.	TX20 2pcs.	TX25 2pcs.	TX27 2pcs.	TX30 2pcs.	TX40 2pcs.	
TXH10 1pc.	TXH15 1pc.	TXH20 1pc.	TXH25 1pc.	TXH30 1pc.	TXH40 1pc.		
90mm PH1 1pc.		90mm PH2 1pc.		90mm PH3 1pc.		90mm PZ1 1pc.	
90mm PZ2 1pc.		90mm TX25 1pc.		90mm TX30 1pc.		90mm 0,5x4 1pc.	
90mm 1x6 1pc.							

INCLUSO
INCLUDED

COD. 62019010



COD. 62013005





66014

ASSORTIMENTI COMPLETI INSERTI 1/4"

ASSORTIMENTO 100 PCS. INSERTI ED ACCESSORI
100 PCS. BITS AND ACCESSORIES

100
pcs.



COD. **66014010**

€ 19,354

+				+			
PH0	PH1	PH2	PH3	PZ0	PZ1	PZ2	PZ3
1pc.	1pc.	5pcs.	1pc.	1pc.	1pc.	5pcs.	1pc.

+								
TX08	TX10	TX15	TX20	TX25	TX27	TX30	TX40	TX45
1pc.	1pc.	1pc.	1pc.	1pc.	1pc.	1pc.	1pc.	1pc.

+								
TXH08	TXH10	TXH15	TXH20	TXH25	TXH27	TXH30	TXH35	TXH40
1pc.	1pc.	1pc.	1pc.	1pc.	1pc.	1pc.	1pc.	1pc.

61001									
1,5	2	2,5	3	4	5	5,5	6	8	
1pc.	1pc.	1pc.	1pc.	1pc.	1pc.	1pc.	1pc.	1pc.	1pc.

61001									
1/16"	5/64"	3/32"	7/64"	1/8"	9/64"	5/32"	3/16"	7/32"	1/4"
1pc.	1pc.	1pc.	1pc.	1pc.	1pc.	1pc.	1pc.	1pc.	1pc.

61001					
2	2,5	3	4	5	6
1pc.	1pc.	1pc.	1pc.	1pc.	1pc.

61001					
5/64"	3/32"	7/64"	1/8"	9/64"	5/32"
1pc.	1pc.	1pc.	1pc.	1pc.	1pc.

+								
3,0x0,5	4,0x0,5	4,5x0,6	5,0x0,8	5,5x0,8	6,0x1,0	6,5x1,2	7,0x1,2	8,0x1,6
1pc.	1pc.	1pc.	1pc.	1pc.	1pc.	1pc.	1pc.	1pc.

+			+				+		
1	2	3	4	6	8	10	5	6	8
1pc.	1pc.	1pc.	1pc.	1pc.	1pc.	1pc.	1pc.	1pc.	1pc.

+			+				+			
6	8	10	1	2	3	4	0	1	2	3
1pc.	1pc.	1pc.	1pc.	1pc.	1pc.	1pc.	1pc.	1pc.	1pc.	1pc.





1.2 LINEE ESSENTIAL

ESSENTIAL LINES

66014

ASSORTIMENTI INSERTI E CHIAVI 1/4" + GIRAVITE

ASSORTIMENTO 138 PCS. INSERTI, CHIAVI ED ACCESSORI

138 PCS. BITS, NUT SETTERS AND ACCESSORIES



138
pcs.

COD. **66014016**

€ 34,440

+			+		
PH1	PH2	PH3	PZ1	PZ2	PZ3
3pcs.	3pcs.	3pcs.	2pcs.	2pcs.	2pcs.

	2pcs. PH1 - 2pcs. PH2 - 2pcs. PH3
	2pcs. PZ1 - 2pcs. PZ2 - 2pcs. PZ3
	2pcs. TX08 - 2pcs. TX10 - 2pcs. TX15 - 5pcs. TX20 - 6pcs. TX25 - 3pcs. TX27 - 4pcs. TX30 - 4pcs. TX40 -
	2pcs. TXH08 - 2pcs. TXH10 - 2pcs. TXH15 - 2pcs. TXH20 - 2pcs. TXH25 - 2pcs. TXH27 - 2pcs. TXH30 - 2pcs. TXH40
	1pc. 10 - 2pcs. 15 - 2pcs. 20 - 3pcs. 25 - 2pcs. 27 - 3pcs. 30 - 2pcs. 40
	1pc. 3 - 1pc. 4 - 1pc. 5 - 1pc. 6 - 1pc. 8
	1pc. 3 - 1pc. 4 - 1pc. 5
	1pc. 4,0x0,5 - 1pc. 4,0x0,6 - 1pc. 5,5x0,8 - 1pc. 6,0x1,0 - 1pc. 6,5x1,2 - 1pc. 8,0x1,6
	1pc. 1 - 1pc. 2 - 1pc. 3
	1pc. 4 - 1pc. 6 - 1pc. 8 - 1pc. 10
	1pc. 5 - 1pc. 6 - 1pc. 8
	1pc. 6 - 1pc. 8 - 1pc. 10
	1pc. 1 - 1pc. 2 - 1pc. 3 - 1pc. 4
	1pc. 1 - 1pc. 2
	1pc. PH1 - 1pc. PH2 - 1pc. PH3
	1pc. PZ1 - 1pc. PZ2 - 1pc. PZ3
	1pc. TX10 - 1pc. TX15 - 1pc. TX20 - 1pc. TX25 - 1pc. TX27 - 1pc. TX30 - 1pc. TX40
	1pc. 4,0x0,5 - 1pc. 5,5x0,8 - 1pc. 6,5x1,2
	1pc. 3 - 1pc. 6
	1pc. 4 - 1pc. 5 - 1pc. 6 - 1pc. 7 - 1pc. 8 - 1pc. 9 - 1pc. 10 - 1pc. 11 - 1pc. 12 - 1pc. 13
	portainseriti - bit holder
	adattatore 1/4"E - 1/4"E adapter
	adattatore 1/4"C - 1/4"C adapter
	25mm
	chiave per tasselli a occhio eye screw fixing key
	200mm



66001

MULTI**BIT** ESPOSITORE INSERTI

ESPOSITORE DA BANCO CON 25 SCOMPARTI
COUNTER DISPLAY WITH 25 COMPARTMENTS

410
pcs.

















445 X 465 X 210 mm

STRUTTURA IN POLIPROPILENE ALVEOLARE AUTOPORTANTE, 25 SCOMPARTI.
SELF-SUPPORTING POLYPROPYLENE HONEYCOMB STRUCTURE, 25 COMPARTMENTS.

COD. **66001300**

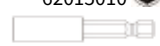
€ 472,965

<p>61043 </p> 			<p>61069 </p> 		
PH1 20pcs.	PH2 50pcs.	PH3 20pcs.	PZ1 20pcs.	PZ2 50pcs.	PZ3 20pcs.
<p>61094 </p> 					
TX10 10pcs.	TX15 10pcs.	TX20 10pcs.	TX25 20pcs.	TX30 20pcs.	TX40 20pcs.
<p>61001 </p> 					
2 10pcs.	2,5 10pcs.	3 10pcs.	4 10pcs.	5 10pcs.	6 10pcs.
<p>61021 </p> 					
0,5x3,0 10pcs.	0,6x4,5 10pcs.	1,0x5,5 10pcs.	1,2x6,5 10pcs.		
<p>63004 </p> 			<p>62015010 </p> 		
8x45 10pcs.	10x45 10pcs.	 1/4"x1/4"x60mm 20pcs.			

1.2



1.2 LINEE ESSENTIAL

ESSENTIAL LINES

66001

MULTISTORE ESPOSITORE A CASSETTI

STRUTTURA ESPOSITORE PER STORE6 E STORE9
DISPLAY STRUCTURE FOR STORE6 AND STORE9



COD. 66001005VC
 Struttura metallica vuota + top
 Empty metal structure + top

610 X 600 X 150 mm

STRUTTURA METALLICA DA BANCO E APPENDIBILE. CASSETTIERE BASCULANTI SOVRAPPONIBILI CHE SI AGGANCIANO ALLA STRUTTURA.
 LA MADIA PUÒ OSPITARE FINO A 6 FILE DI CASSETTIERE (4 SE DEL TIPO A 6 CASSETTI)
 COUNTERTOP AND HANGABLE METAL STRUCTURE. UP-AND-OVER DRAWERS THAT CAN BE HOOKED ONTO THE STRUCTURE.
 THE DISPLAY CABINET CAN HOLD UP TO 6 ROWS OF DRAWERS (4 FOR THE STORE6 CABINET)



Personalizza il MULTISTORE scegliendo tra le versioni seguenti.

Customise your MULTISTORE by choosing from the following versions.

1

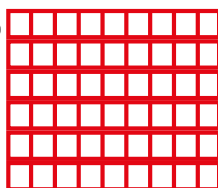

6 x **STORE9**

2

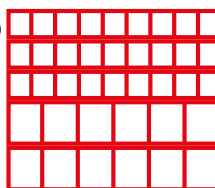

3 x **STORE9** + 2 x **STORE6**

3

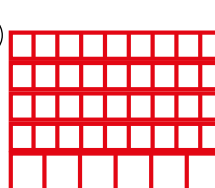

4 x **STORE9** + 1 x **STORE6**

STORE9 PREMIUM

p. 37	MAG-Bit+™		66001080	€ 242,827
p. 49	COLOUR+		66001085	€ 186,278
p. 62	PULSAR*		66001055	€ 216,966
p. 62	PULSAR*		66001056	€ 311,808
p. 75	TORSION*		66001060	€ 165,379
p. 75	TORSION*		66001061	€ 196,538
p. 87	TORSION+		66001065	€ 205,800
p. 99	HDC		66001070	€ 304,584
p. 99	HDC		66001071	€ 318,696
p. 111	TITANIUM		66001050	€ 265,574
p. 111	TITANIUM		66001051	€ 258,406
p. 122	INX		66001075	€ 278,029
p. 122	INX		66001076	€ 257,242

STORE9 ESSENTIAL

p. 185	ESSENTIAL	66001020	€ 172,144
p. 185	ESSENTIAL	66001025	€ 227,360
p. 185	ESSENTIAL	66001030	€ 227,920
p. 185	ESSENTIAL	66001035	€ 186,278
p. 185	ESSENTIAL	66001040	€ 219,386
p. 185	ESSENTIAL	66001045	€ 323,893

STORE6 ESSENTIAL

p. 195	ESSENTIAL	66001105	€ 169,075
p. 211	ESSENTIAL	66001120	€ 329,246

STORE6

p. 333		66001110	€ 222,824
p. 351		66001115	€ 261,990

**66001****STORE 9 ASSORTIMENTI ESSENTIAL****CASSETTIERA CON 9 SCOMPARTI PER ESPOSITORE MULTISTORE**
DRAWERS WITH 9 COMPARTMENTS FOR MULTISTORE DISPLAY

600 X 90 X 65 mm

200
pcs.COD. **66001025**

€ 227,360

61001				61021				
2,5	3	4	5	6	0,5x3,0	0,6x4,0	1,0x5,5	1,2x6,5
10pcs.	20pcs.	20pcs.	30pcs.	30pcs.	10pcs.	20pcs.	30pcs.	30pcs.

170
pcs.COD. **66001035**

€ 186,278

61094					61111			
TX15	TX20	TX25	TX30	TX40	TXH15	TXH20	TXH25	TXH30
20pcs.	20pcs.	30pcs.	30pcs.	30pcs.	10pcs.	10pcs.	10pcs.	10pcs.

220
pcs.COD. **66001020**

€ 172,144

61043				61069			
PH0	PH1	PH2	PH3	PZ0	PZ1	PZ2	PZ3
10pcs.	25pcs.	50pcs.	20pcs.	10pcs.	25pcs.	50pcs.	20pcs.

180
pcs.COD. **66001030**

€ 227,920

61094							
TX09	TX10	TX15	TX20	TX25	TX27	TX30	TX40
10pcs.	10pcs.	20pcs.	30pcs.	30pcs.	10pcs.	30pcs.	30pcs.

62015010



1/4"x1/4"x60mm

10pcs.

62016010



1/4"x1/4"x60mm

10pcs.

240
pcs.COD. **66001040**

€ 219,386

61048			61073		
PH1	PH2	PH3	PZ1	PZ2	PZ3
25pcs.	50pcs.	20pcs.	25pcs.	50pcs.	20pcs.

150
pcs.COD. **66001045**

€ 323,893

61051			61076		
PH1	PH2	PH3	PZ1	PZ2	PZ3
10pcs.	30pcs.	10pcs.	10pcs.	30pcs.	10pcs.

61056



PH2

20pcs.

61082



PZ2

20pcs.

61097



TX25

10pcs.

TX30

20pcs.

TX40

20pcs.

62015010



1/4"x1/4"x60mm

10pcs.



1.2 LINEE ESSENTIAL

ESSENTIAL LINES

66001

MULTIBOX ESPOSITORE MINIBOX

ESPOSITORE DA BANCO IN FILO METALLICO PER MINIBOX
METAL WIRE COUNTER DISPLAY FOR MINIBOX



270
pcs.

COD. **66001501**

€ 360,394

			L mm	COD.	box
10 pcs.		PH1	25	61043010010	2
10 pcs.		PH2	25	61043020010	3
10 pcs.		PH3	25	61043030010	2
5 pcs.		PH2	50	61051045005	2
10 pcs.		PZ1	25	61069010010	2
10 pcs.		PZ2	25	61069020010	3
10 pcs.		PZ3	25	61069030010	2
5 pcs.		PZ2	50	61076035005	2
10 pcs.		TX20	25	61094035010	2
10 pcs.		TX25	25	61094040010	2
10 pcs.		TX30	25	61094050010	3
10 pcs.		TX40	25	61094055010	3
1 pc.		MYBIT 7		66002105	2
1 pc.		MYBIT 7 POWER		66007100	2
1 pc.				62015005001	3
1 pc.				62029005	3

370 X 545 X 220 mm

STRUTTURA IN FILO METALLICO DA BANCO ED APPENDIBILE ADATTA AD ACCOGLIERE
 20 MISURE DIVERSE DI INSERTI CONFEZIONATI IN MINIBOX E DUE ARTICOLI ACCESSORI.
 COUNTERTOP OR WALL-MOUNTED METAL WIRE STRUCTURE, SUITABLE FOR HOLDING BITS
 IN 20 DIFFERENT SIZES, MINIBOX PACKED AND TWO ACCESSORIES.





1.2 LINEE ESSENTIAL

ESSENTIAL LINES

63002

CHIAVI A BUSSOLA NON MAGNETICHE

CHIAVI 1/4"E A BUSSOLA NON MAGNETICHE

1/4"E NON-MAGNETIC NUT SETTERS

48/50 HRC

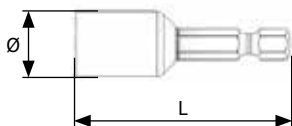

EASYPACK | sacchetto PVC con Euro-hole - PVC bags with Euro-hole

Ø mm	L mm	PCS.	COD.	€ cad./each	
5	45	10	5	63002002	1,995
5,5	45	10	5	63002003	1,995
6	45	11	5	63002004	1,995
7	45	12,5	5	63002005	2,242
	65	12,5	5	63002009	2,772
8	45	12,5	5	63002010	2,242
	65	12,5	5	63002011	2,772
10	45	14,5	5	63002015	2,514
	65	14,5	5	63002016	3,006
11	45	16	5	63002017	2,772
12	45	18	5	63002019	2,871
	65	18	5	63002021	3,634
13	45	18,5	5	63002020	3,006
	65	18,5	5	63002025	3,869
17	50	24	5	63002050	11,076

Ø mm	L mm	COD.	€ box	
7	12,5	45	63002005001	3,751
8	12,5	45	63002010001	3,751
10	14,5	45	63002015001	3,991
13	18,5	45	63002020001	4,453



SELPACK
1 pc.

63004

CHIAVI A BUSSOLA MAGNETICHE

CHIAVI 1/4"E A BUSSOLA MAGNETICHE

1/4"E MAGNETIC NUT SETTERS

48/50 HRC

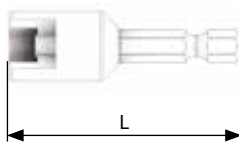

EASYPACK | sacchetto PVC con Euro-hole - PVC bags with Euro-hole

Ø mm	L mm	PCS.	COD.	€ cad./each	
5	45	10	5	63004005	2,365
5,5	45	10	5	63004010	2,365
6	45	11	5	63004015	2,365
7	45	12,5	5	63004020	2,625
	65	12,5	5	63004025	3,142
8	45	12,5	5	63004030	2,625
	65	12,5	5	63004035	3,142
10	45	14,5	5	63004040	2,871
	65	14,5	5	63004045	3,376
11	45	16	5	63004050	3,142
12	45	18	5	63004055	3,241
13	45	18,5	5	63004060	3,499
	65	18,5	5	63004065	4,362
17	50	24	5	63004100	12,443

Ø mm	L mm	COD.	€ box	
5,5	10	45	63004010001	4,016
6	11	45	63004015001	4,016
7	12,5	45	63004020001	4,275
8	12,5	45	63004030001	4,275
10	14,5	45	63004040001	4,521
13	18,5	45	63004060001	5,150
17	50	24	63004100001	14,045



SELPACK
1 pc.

**63006**

CHIAVI A BUSSOLA MAGNETICHE (POLLICI)

CHIAVI 1/4" E A BUSSOLA MAGNETICHE MISURE IN POLLICI
1/4" E MAGNETIC NUT SETTERS INCHES SIZES

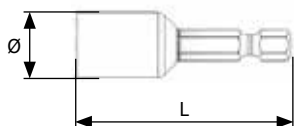
48/50 HRC

EASYPACK | sacchetto PVC con Euro-hole - PVC bags with Euro-hole

	L mm	Ø mm	PCS.	COD.	€ cad./each
1/4"	45	11	5	63006005	4,854
5/16"	45	12,5	5	63006010	5,051
3/8"	45	14	5	63006015	5,383

1.2**63010**

CHIAVI A BUSSOLA PER VITI INOX

CHIAVI 1/4" E A BUSSOLA CON SFERA PER TRATTENERE IL DADO
1/4" E NUT SETTERS WITH BALL FOR SCREW RETENTION

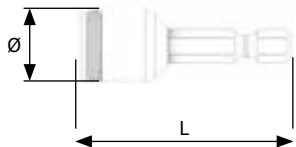
48/50 HRC

EASYPACK | sacchetto PVC con Euro-hole - PVC bags with Euro-hole

	L mm	PCS.	COD.	€ cad./each
6	45	5	63010005	6,899
7	45	5	63010010	6,899
8	45	5	63010015	6,899
10	45	5	63010025	7,504
11	45	5	63010030	7,504
12	45	5	63010035	9,598
13	45	5	63010040	9,598
14	45	5	63010045	9,598

**FOCUS ON**

Una sfera che agisce sulla superficie del dado/bullone esercitando il trattenimento anche su acciaio inox, ottone o altri metalli non ferrosi.

A ball that acts on the surface of the nut/bolt, exerting retention even on stainless steel, copper or other non-ferrous metals.



1.2 LINEE ESSENTIAL

ESSENTIAL LINES

63001

CHIAVI A BUSSOLA NON MAGNETICHE AD ALTA RESISTENZA

CHIAVI 1/4" E A BUSSOLA NON MAGNETICHE AD ALTA RESISTENZA
1/4" E NON-MAGNETIC HIGH-RESISTANCE NUT SETTERS

56/58 HRC

EASYPACK | sacchetto PVC con Euro-hole - PVC bags with Euro-hole

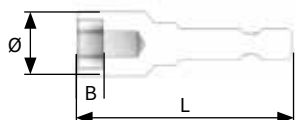

Ø	L mm	Ø mm	B	PCS.	COD.	€ cad./each
4	50	7,5	2,5	5	63001005	10,349
	75	7,5	2,5	5	63001170	13,104
	100	7,5	2,5	5	63001175	21,952
4,5	50	8	2,5	5	63001010	10,349
	75	8	2,5	5	63001180	13,104
	100	8	2,5	5	63001185	21,952
5	50	9	3	5	63001015	9,598
	75	9	3	5	63001020	13,104
	100	9	3	5	63001025	21,952
5,5	50	9	3,5	5	63001030	9,598
	75	9	3,5	5	63001035	13,104
	100	9	3,5	5	63001040	21,952
6	50	10	4	5	63001045	9,598
	75	10	4	5	63001050	13,104
	100	10	4	5	63001055	21,952
7	50	11	4,5	5	63001060	8,254
	75	11	4,5	5	63001065	11,424
	100	11	4,5	5	63001070	13,552
8	50	13	5,5	5	63001075	8,254
	75	13	5,5	5	63001080	11,424
	100	13	5,5	5	63001085	13,552
						31,808

Ø	L mm	Ø mm	B	PCS.	COD.	€ cad./each
9	50	14	5,5	5	63001090	8,557
	75	14	5,5	5	63001095	11,760
	100	14	5,5	5	63001190	39,648
10	50	15	6,5	5	63001100	8,557
	75	15	6,5	5	63001105	11,760
	100	15	6,5	5	63001110	14,336
11	50	17	7,5	5	63001115	13,440
	75	17	7,5	5	63001120	16,240
	100	17	7,5	5	63001195	18,480
12	50	18	8,5	5	63001125	13,440
	75	18	8,5	5	63001130	16,240
	100	18	8,5	5	63001135	18,480
13	50	19	9,5	5	63001140	13,440
	75	19	9,5	5	63001145	13,664
	100	19	9,5	5	63001150	16,240
14	50	20	10,5	5	63001155	29,456
	75	20	10,5	5	63001160	34,384
	100	20	10,5	5	63001200	35,728
15	50	24	11,5	5	63001205	54,096
17	50	25	11,5	5	63001165	32,592



TIPS

Chiavi a bussola ad alta resistenza realizzate in acciaio speciale al cromo-silicio-vanadio, utilizzabili anche con avvitatori ad impulsione. (N.B: La massima forza applicabile non deve superare quelle indicate per l'attacco esagonale 1/4", vedi dati tecnici in coda al catalogo)

High-strength nut setters made of special chrome-silicon-vanadium steel, which can also be used with impact wrenches. (N.B: The maximum forces that can be applied must not exceed those specified for 1/4" hex attachments, see technical data at the end of the catalogue)

63003

CHIAVI A BUSSOLA MAGNETICHE AD ALTA RESISTENZA

CHIAVI 1/4"E A BUSSOLA MAGNETICHE AD ALTA RESISTENZA 1/4"E MAGNETIC HIGH-RESISTANCE NUT SETTERS

56/58 HRC

EASYPACK | sacchetto PVC con Euro-hole - PVC bags with Euro-hole

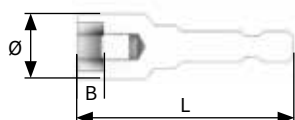

●	L mm	Ø mm	B	PCS.	COD.	€ cad./each
4	50	7,5	1,5	5	63003005	13,440
	75	7,5	1,5	5	63003170	16,128
	100	7,5	1,5	5	63003175	24,976
4,5	50	8	1,5	5	63003010	13,440
	75	8	1,5	5	63003180	16,128
	100	8	1,5	5	63003185	24,976
5	50	9	2	5	63003015	12,656
	75	9	2	5	63003020	16,128
	100	9	2	5	63003025	24,976
5,5	50	9	2	5	63003030	12,656
	75	9	2	5	63003035	16,128
	100	9	2	5	63003040	24,976
6	50	10	2,5	5	63003045	12,656
	75	10	2,5	5	63003050	16,128
	100	10	2,5	5	63003055	24,976
7	50	11	3	5	63003060	12,768
	75	11	3	5	63003065	15,904
	100	11	3	5	63003070	18,032
8	150	11	3	5	63003215	36,400
	50	13	3	5	63003075	12,768
	75	13	3	5	63003080	15,904
8	100	13	3	5	63003085	18,032
	150	13	3	5	63003225	36,400

●	L mm	Ø mm	B	PCS.	COD.	€ cad./each
9	50	14	4	5	63003090	13,104
	75	14	4	5	63003095	16,240
	100	14	4	5	63003190	42,448
10	50	15	4	5	63003100	13,104
	75	15	4	5	63003105	16,240
	100	15	4	5	63003110	18,816
11	150	15	4	5	63003235	37,296
	50	17	5	5	63003115	17,920
	75	17	5	5	63003120	20,720
12	100	17	5	5	63003195	22,960
	50	18	6	5	63003125	17,920
	75	18	6	5	63003130	20,720
13	100	18	6	5	63003135	22,960
	50	19	6	5	63003140	17,920
	75	19	6	5	63003145	18,256
14	100	19	6	5	63003150	20,720
	50	20	6	5	63003155	33,936
	75	20	6	5	63003160	38,864
17	100	20	6	5	63003200	40,208
	50	25	7	5	63003165	37,072



FOCUS ON



Su richiesta possiamo realizzare chiavi a bussola fino a lunghezza 390 mm, con cave differenti (es. poligonale, TORX® femmina, quadro). Siamo inoltre in grado di tarare la durezza finale in base alle specifiche necessità.

On request, we are also able to manufacture nut setters up to 390 mm long, with different slots (e.g. polygonal, TORX® female, square). We are also able to calibrate the final hardness according to specific needs.



1.2 LINEE ESSENTIAL

ESSENTIAL LINES

63005

CHIAVI A BUSSOLA MAGNETE RETRATTILE

CHIAVI 1/4" E A BUSSOLA ALTA RESISTENZA CON MAGNETE RETRATTILE
1/4" E NUT SETTERS WITH SPRING LOADED MAGNET

56/58 HRC



EASYPACK | sacchetto PVC con Euro-hole - PVC bags with Euro-hole

Ø mm	L mm	Ø mm	PCS.	COD.	€ cad./each
7	75	11	1	63005005	48,216
8	75	13	1	63005010	48,216
10	75	15	1	63005015	50,921



FOCUS ON

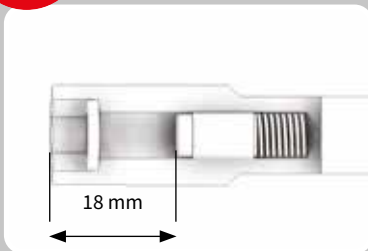

Il sistema magnete retrattile permette sia il trattenimento magnetico del dado che l'ingresso libero della vite nella chiave per una profondità massima di 18mm.

The retractable magnet system allows both magnetic retention of the nut and the free entry of the screw into the nut setter for a maximum depth of 18mm.

63012

CHIAVI A BUSSOLA SCARICO PROFONDO

CHIAVI 1/4" E A BUSSOLA CON SCARICO PROFONDO
1/4" E DEEP HOLE NUT SETTERS

52/54 HRC



EASYPACK | sacchetto PVC con Euro-hole - PVC bags with Euro-hole

Ø mm	L mm	dxℓ mm	Ø mm	PCS.	COD.	€ cad./each
7	100	6x50	11	5	63012005	15,523
	150	6x100	11	5	63012010	39,161
8	100	7x50	13	5	63012015	15,523
	150	7x100	13	5	63012020	39,161
10	100	8x50	15	5	63012025	15,758
	150	8x100	15	5	63012030	41,042
13	100	10x50	19	5	63012035	19,169
	150	10x100	19	5	63012040	44,100

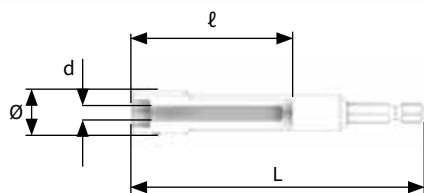

FOCUS ON



Ideali quando il gambo filettato sporge molto dal dado o per l'avvitatura di prigionieri.

Ideal when the threaded shaft protrudes significantly from the nut or for screwing captive screws.

**63011**

CHIAVI A BUSSOLA IMPACT MAGNETICHE

CHIAVI 1/4" E A BUSSOLA MAGNETE FLOTTANTE PER AVVITATORI A MASSA BATTENTE
1/4" E NUT SETTERS WITH FLOATING MAGNET FOR IMPACT WRENCHES

56/58 HRC

EASYPACK | sacchetto PVC con Euro-hole - PVC bags with Euro-hole

	L mm	Ø mm	PCS.	COD.	€ cad./each
7	65	11	5	63011010	7,414
8	65	12,5	5	63011015	7,414
10	65	15	5	63011025	8,187
13	65	18,5	5	63011040	9,173



FOCUS ON



Realizzate in acciaio speciale al cromo-silicio-vanadio hanno una durezza e una resistenza alla torsione molto elevate.

Made of special chrome-silicon-vanadium steel, they are very hard and extremely resistant to twisting.

63011

DISPLAY DA BANCO CHIAVI A BUSSOLA IMPACT MAGNETICHE

ESPOSITORE 24 PCS. CHIAVI A BUSSOLA MAGNETICHE IMPACT
24 PCS. MAGNETIC IMPACT NUT SETTERS DISPLAY

**24
pcs.**COD. **63011002**
€ 183,926

63011

7
6pcs.8
6pcs.10
6pcs.13
6pcs.

120 X 40 X 195 mm



1.2 LINEE ESSENTIAL

ESSENTIAL LINES

63600

ASSORTIMENTI CHIAVI A BUSSOLA NON MAGNETICHE

ASSORTIMENTO 10 PEZZI CHIAVI A BUSSOLA NON MAGNETICHE
 10 PCS. NON-MAGNETIC NUT SETTERS SET



10
pcs.

COD. **63600001**
€ 9,296



4	5	5,5	6	7	8	9	10	12	13
2pcs.	1pc.	1pc.	1pc.	1pc.	1pc.	1pc.	1pc.	1pc.	1pc.

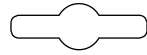

EURO-HOLE

85 X 150 mm

63600

ASSORTIMENTI CHIAVI A BUSSOLA MAGNETICHE

ASSORTIMENTO 6 PEZZI CHIAVI A BUSSOLA MAGNETICHE
 6 PCS. MAGNETIC NUT SETTERS SET



6
pcs.

COD. **63600005**
€ 9,733



5,5	6	7	8	10	13
1pc.	1pc.	1pc.	1pc.	1pc.	1pc.

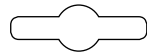

EURO-HOLE

85 X 150 mm



63600

DISPLAY DA BANCO CHIAVI A BUSSOLA

ESPOSITORE DA BANCO IN PER 24 PEZZI
DISPLAY FOR 24 PIECES



120 X 40 X 195 mm

24
pcs.

COD. **63600016**
€ 66,891



7
6pcs.

8
6pcs.

10
6pcs.

13
6pcs.

1.2

66001

STORE 6 ASSORTIMENTI ESSENTIAL

CASSETTIERA CON 6 SCOMPARTI PER ESPOSITORE MULTISTORE
DRAWERS WITH 6 COMPARTMENTS FOR MULTISTORE DISPLAY



600 X 115 X 65 mm

50
pcs.

COD. **66001105**
€ 169,075

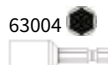

5,5
5pcs.

7
10pcs.

8
10pcs.

10
10pcs.

13
10pcs.

17
5pcs.



MULTI STORE

COD. 66001005VC

PER DETTAGLI E COMPOSIZIONE VEDERE P. 184
FOR DETAILS AND COMPOSITION SEE P. 184



Fino a non molti anni fa esistevano solo due tipi di porta-inserti: quello non magnetico e quello magnetico. Oggi le soluzioni offerte sono molte e scegliere l'accessorio giusto può essere di aiuto a rendere più facile il lavoro. Per questo motivo, la terza sezione del capitolo, dedicata agli accessori per inserti da 1/4", è ampiamente corredata di indicazioni e suggerimenti utili per individuare correttamente l'accessorio più adatto.

The market for bit holders offers solutions that are increasingly more specific and that adapt well to the working conditions or workpieces. Having the right accessory will make the job easier and faster. For this reason, the third section of the chapter contains accessories for 1/4" bits together with lots of useful suggestions and tips on how to find the most suitable accessory for every type of application or work environment.



1.3

PORTAINSERTI/ ADATTATORI BIT HOLDERS/ADAPTERS

PORTAINSERTI 1/4" C

1/4" C BIT HOLDER



MAGNETICI
MAGNETIC

p. 201



SNODATI/FLESSIBILI
JOINTED/FLEXIBLE

p. 204



MAGNETICI CON BLOCCO
MAGNETIC WITH BLOCK

p. 204



DOPPIO MAGNETE
TWO MAGNETS

p. 208



ANTIGRAFFIO
SCRATCH-RESISTANT

p. 209



NON MAGNETICI
NON-MAGNETIC

p. 212



ATTACCO SDS PLUS®
SDS PLUS® ATTACHMENT

p. 213



ATTACCO 5/16" RAPIDO
5/16" QUICK ATTACHMENT

p. 213



ATTACCO 5,5mm
5.5 mm ATTACHMENT

p. 213



CON IMPUGNATURA
WITH HANDLE

p. 216



ATTACCO QUADRO
SQUARE ATTACHMENT

p. 217

PORTAINSERTI 1/4" E

1/4" E BIT HOLDER



ATTACCO 1/4"
1/4" ATTACHMENT

p. 222



SNODATI/FLESSIBILI
JOINTED/FLEXIBLE

p. 222



CON IMPUGNATURA
WITH HANDLE

p. 223



ATTACCO QUADRO
SQUARE ATTACHMENT

p. 223

RINVII ANGOLARI

ANGLE DRIVER



PER INSERTE 1/4" C - 1/4" E
FOR BITS 1/4" C - 1/4" E

p. 225

ADATTATORI

ADAPTERS



ADATTATORI
ADAPTERS

p. 229

ACCESSORI

ACCESSORIES



MAGNETIZZATORI
MAGNETISERS

p. 233



ESTRATTORI
EXTRACTORS

p. 235

GUIDA AI PORTAINSERTI

GUIDE TO BIT HOLDERS

	1/4" E	1/4" E	1/4" E	1/4" E	1/4" E	SDS plus S-3	5/16" C	5,5 mm	1/4" E	1/4" E	1/4" E	1/4" E	1/4" E	1/4" E	1/4" E	1/4" E	1/4" E	1/4" E	1/4" E	
	✓		✓	✓	✓	✓	✓	✓	✓											
																	✓	✓		
		✓	✓	✓	✓	✓	✓	✓	✓	✓	✓	✓	✓		✓				✓	✓
																				✓
										✓	✓	✓	✓	✓	✓	✓			✓	
														✓		✓				
	☐	☐	☐	☐	☐	☐	☐	☐	☐	☐	☐	☐	☐	☐	☐	☐	☐	☐	☐	☐
	✓	✓	✓	✓	✓	✓	✓	✓		✓	✓	✓	✓	✓	✓	✓	✓		✓	✓
Impact								✓												
			✓	✓	✓		✓	✓	✓	✓	✓				✓	✓				
Inox					✓						✓									
																				✓
																		✓	✓	
Zone difficili Difficult zones												✓	✓		✓		✓	✓	✓	
XL		✓	✓							✓			✓		✓				✓	
1/4" C	p. 212	p. 201	p. 201	p. 202	p. 202	p. 213	p. 213	p. 213	p. 203	p. 204	p. 205	p. 207	p. 205	p. 206	p. 206	p. 207	p. 203	p. 204		p. 208
1/4" E															p. 206	p. 222				p. 222
3/8" 10mm																				
5/16" C																				
4mm C																				

		✓	✓		✓			✓			✓											
				✓			✓			✓								✓			✓	
	✓	✓	✓										✓	✓	✓	✓	✓			✓	✓	
							✓		✓			✓					✓					
	✓	✓	✓		✓	✓			✓			✓		✓	✓							
					✓						✓											
			✓		✓	✓			✓		✓		✓									
	✓	✓																				
																				✓		
Zone difficili Difficult zones																				✓	✓	✓
XL															✓					✓		
	p. 208	p. 209	p. 209	p. 217	p. 217	p. 217	p. 218	p. 218	p. 219	p. 220	p. 220	p. 220						p. 216	p. 216	p. 216	p. 214	p. 215
									p. 223	p. 223												
							p. 243			p. 243												
							p. 249	p. 249		p. 250	p. 250											
																						p. 259 p. 261 p. 263 p. 265 p. 266
													p. 256	p. 256								

PORTAINSERTI

PORTAINSERTI PER INSERTI 1/4" C E LAME 1/4" E
Bit holder for 1/4" C bits and 1/4" E power-bits

Corpo in acciaio INOX (HRA 64/66) resistente alle sollecitazioni trasmesse dall'inserto. Magnete permanente in Neodimio-Ferro-Boro; forza di trattenimento superiore del 100% a quanto richiesto dalle normative internazionali.

Body in STAINLESS steel (HRA 64/66), resistant to stress transmitted by the insert bit. Permanent magnet in Neodymium-Iron-Boron; retention strength greater than 100% as required by international standards.

Attacco in S2, lo stesso materiale utilizzato per la fabbricazione degli inserti Essential. Ottima resistenza all'usura.

Attachment in S2, the same material used to manufacture the Essential bits. Excellent wear resistance.



Materie prime di ottima qualità utilizzate per la fabbricazione dei nostri porta-inserti, come gli inserti.

Our bit holders and bits are made using raw materials of the highest quality.



Progettati per funzionare al meglio in coppia con tutti gli inserti della gamma LTI.

Designed to work best in combination with LTI range bits.



Ampia scelta di soluzioni per rendere più facile qualsiasi operazione di assemblaggio.

Wide range of solutions to make any assembly operation easier.

**62013****MAGNETICI SENZA ANELLO****PORTAINSERTI 1/4"E MAGNETICO PER INSERTI 1/4"C**
MAGNETIC 1/4"E BIT-HOLDER FOR 1/4"C BITS

EASYPACK | sacchetto PVC con Euro-hole - PVC bags with Euro-hole

L mm	Ø mm	PCS.	COD.	€ cad./each
50	10	5	62013004	4,618
60	10	5	62013005	4,772
75	10	5	62013010	5,722
100	10	5	62013015	10,495
120	10	5	62013020	14,721
150	10	5	62013025	15,315
200	10	5	62013030	17,214
250	10	5	62013035	28,018

BOX
25 pcs.

L mm	COD.	€ box
50	62013004025	92,220
60	62013005025	95,400
75	62013010025	114,480

SELFPACK
1 pc.

L mm	COD.	€ box
50	62013004001	6,209
60	62013005001	6,363
75	62013010001	7,313
100	62013015001	12,109

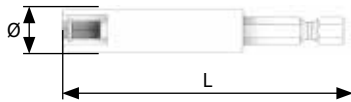
62015**MAGNETICI CON ANELLO****PORTAINSERTI MAGNETICO CON ANELLO C 1/4"E PER INSERTI 1/4"C**
MAGNETIC 1/4"E BIT-HOLDER WITH C RING FOR 1/4"C BITS

EASYPACK | sacchetto PVC con Euro-hole - PVC bags with Euro-hole

L mm	Ø mm	PCS.	COD.	€ cad./each
50	10	5	62015005	5,413
60	10	5	62015010	5,568
75	10	5	62015015	6,209
100	10	5	62015020	11,136
120	10	5	62015025	15,315
150	9,8	5	62015030	16,146
200	9,8	5	62015035	17,808
250	11	5	62015040	28,730
400	11	5	62015070	31,817

BOX
25 pcs.

L mm	COD.	€ box
50	62015005025	108,120
60	62015010025	111,300
75	62015015025	124,020

SELFPACK
1 pc.

L mm	COD.	€ box
50	62015005001	7,004
60	62015010001	7,159
75	62015015001	7,799
100	62015020001	12,822
120	62015025001	16,858
150	62015030001	17,689
200	62015035001	19,470
250	62015040001	30,274



1.3 PORTAINSERTI/ADATTATORI BIT HOLDERS/ADAPTERS

62015

PORTAINSERTI INX

PORTAINSERTI 1/4" E IN ACCIAIO INOX INTEGRALE MAGNETICO CON ANELLO PER INSERTE 1/4" C
1/4" E STAINLESS STEEL BIT HOLDER WITH C-RING AND MAGNET FOR 1/4" C BITS

EASYPACK | sacchetto PVC con Euro-hole - PVC bags with Euro-hole



L mm	Ø mm	PCS.	COD.	€ cad./each
60	11	5	62015105	8,429



VEDI P. 118
SEE P. 118



SELPACK
1 pc.

L mm	COD.	€ box
60	62015105001	9,961

62012

MAGNETE EXTRAFORTE CORPO RINFORZATO

PORTAINSERTI 1/4" E MAGNETICO CON ANELLO C PER INSERTE 1/4" C - PER BUSSOLE GUIDA
MAGNETIC 1/4" E BIT-HOLDER WITH C RING FOR 1/4" C BITS - FOR FINDER SLEEVES

EASYPACK | sacchetto PVC con Euro-hole - PVC bags with Euro-hole



L mm	Ø mm	PCS.	COD.	€ cad./each
60	11	5	62012005	8,500
75	11	5	62012010	8,845

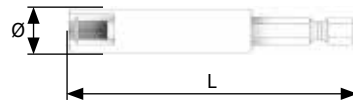

TIPS



Portainseriti adatti all'utilizzo con inserti a taglio tipo lungo 61022 (p.156) e bussole guida 61025 (p.156).

Bit-holder suitable for use with long slotted bits, code 61022 (p. 156), and guide sockets, code 61025 (p. 156).

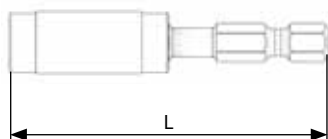
**62035****PULSAR®** **PORTAINSERTI MAGNETICO ANTI-SHOCK PER AVVITATORI A MASSA BATTENTE**
ANTI-SHOCK MAGNETIC BIT-HOLDER FOR IMPACT WRENCHESVEDI P. 57
SEE P. 57

EASYPACK | sacchetto PVC con Euro-hole - PVC bags with Euro-hole

L mm	Ø mm	PCS.	COD.	€ cad./each
60	11	5	62035005	11,765

SELPACK
1 pc.

COD.	€ box
62035005001	13,415

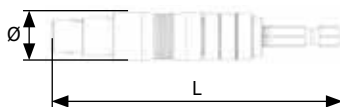
62018**SNODATI****PORTAINSERTI 1/4"E SNODATO CON BLOCCO PER INSERITI 1/4"C**
ARTICULATED 1/4"E BIT HOLDER WITH LOCK FOR 1/4"C BITS

EASYPACK | sacchetto PVC con Euro-hole - PVC bags with Euro-hole

L mm	Ø mm	PCS.	COD.	€ cad./each
94	14	5	62018005	20,420

SELPACK
1 pc.

L mm	Ø mm	COD.	€ box
94	14	62018005001	21,963

**FOCUS ON**

Ideale per lavorare in spazi ridotti o scomodi dove non sia possibile avvitare in asse con la vite. Muovendo la ghiera può lavorare in posizione rettilinea.

Ideal for working in tight or difficult spaces where a second screw cannot be inserted. Move the ring nut to work in a straight position.



1.3 PORTAINSERTI/ADATTATORI

BIT HOLDERS/ADAPTERS

62018

FLESSIBILI

PORTAINSERTI 1/4" E FLESSIBILE PER INSERTI 1/4" C
FLEXIBLE 1/4" E BIT-HOLDER FOR 1/4" C BITS



SELFPACK
1 pc.

EASYPACK | sacchetto PVC con Euro-hole - PVC bags with Euro-hole

L mm	Ø mm	PCS.	COD.	€ cad./each
150	12	5	62018010	10,495

L mm	Ø mm	COD.	€ box
150	12	62018010001	12,109



FOCUS ON

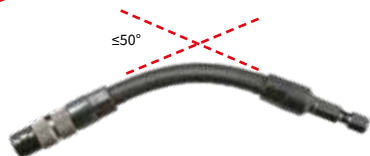

Grazie all'estrema flessibilità si presta a lavorare in spazi difficilmente raggiungibili.

Its extreme flexibility is perfect for working in difficult to reach spaces.

62016

MANDRINO DI BLOCCO

PORTAINSERTI 1/4" E MAGNETICO CON MANDRINO DI BLOCCO PER INSERTI 1/4" C
MAGNETIC 1/4" E BIT-HOLDER WITH LOCK CHUCK FOR 1/4" C BITS

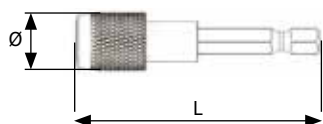

SELFPACK
1 pc.

EASYPACK | sacchetto PVC con Euro-hole - PVC bags with Euro-hole

L mm	Ø mm	PCS.	COD.	€ cad./each
60	14	5	62016005	8,109
75	14	5	62016010	10,495
100	14	5	62016015	31,580
120	14	5	62016020	31,817
150	14	5	62016025	33,479
200	14	5	62016030	34,666
250	14	5	62016035	36,922

L mm	COD.	€ box
60	62016005001	9,699



FOCUS ON

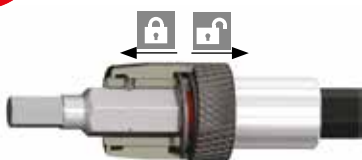

Le sfere di tenuta bloccano l'inserto: questo articolo è consigliato per l'uso con inserti esagonali che tendono a bloccarsi nella cava della vite.

The sealing balls block the bit: this article is recommended for use with hexagon bits that tend to become blocked in the slot of the screw.

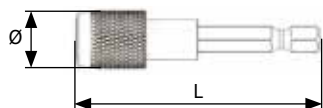
**62016****PORTAINSERTI INX MANDRINO DI BLOCCO****PORTAINSERTI 1/4" E IN ACCIAIO INOX MAGNETICO CON MANDRINO DI BLOCCO**
1/4" E STAINLESS STEEL BIT HOLDER WITH LOCK CHUCK AND MAGNETVEDI P. 118
SEE P. 118

EASYPACK | sacchetto PVC con Euro-hole • PVC bags with Euro-hole

L mm	Ø mm	PCS.	COD.	€ cad./each
60	14	5	62016105	10,970

SELFPACK
1 pc.

L mm	COD.	€ box
60	62016105001	12,584

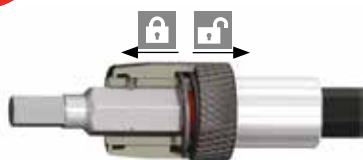
**FOCUS ON**

Le sfere di tenuta bloccano l'inserto: questo articolo è consigliato per l'uso con inserti esagonali che tendono a bloccarsi nella cava della vite.

The sealing balls block the bit: this article is recommended for use with hexagon bits that tend to become blocked in the slot of the screw.

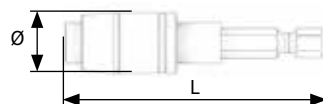
62019**PORTAINSERTI EXTRA LUNGI CON GUIDA****P.INS.1/4 E MAGNETICO EXTRA-LUNGO CON CANOTTO DI GUIDA PER INSERTI 1/4" C**
EXTRA LONG 1/4" E MAGNETIC BIT-HOLDER WITH GUIDE SLEEVE FOR 1/4" C BITS

EASYPACK | sacchetto PVC con Euro-hole • PVC bags with Euro-hole

L mm	Ø mm	PCS.	COD.	€ cad./each
150	16	1	62019030	17,808
300	16	1	62019033	25,169
450	16	1	62019035	33,360

SELFPACK
1 pc.

L mm	COD.	€ box
150	62019030001	19,351
300	62019033001	26,712
450	62019035001	34,904

**FOCUS ON**

Questi portainseriti sono dotati di un canotto grazie al quale possono essere tenuti con le dita e quindi guidati con maggior precisione sulla testa della vite.

These bit holders are equipped with a tube thanks to which they can be held with fingers and then guided more precisely on the head of the screw.



1.3 PORTAINSERTI/ADATTATORI BIT HOLDERS/ADAPTERS

62019

MANDRINO DI BLOCCO SGANCIO RAPIDO

PORTAINSERTI MAGNETICO 1/4"E CON MANDRINO, RAPIDO PER INSERTEI 1/4"C
1/4"E MAGNETIC BIT-HOLDER WITH QUICK CHUCK FOR 1/4"C BITS

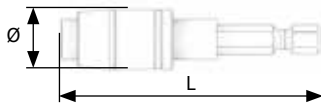

EASYPACK | sacchetto PVC con Euro-hole • PVC bags with Euro-hole

L mm	Ø mm	PCS.	COD.	€ cad./each
65	16	5	62019010	16,621



SELPACK
1 pc.

L mm	COD.	€ box
65	62019010001	18,164



FOCUS ON



Sistema di espulsione rapida dell'inserto, ideale per chi lavora con guanti o a contatto con olio. Tirare la ghiera sia per inserire che per estrarre l'inserto.
Rapid expulsion system of the bit, ideal for those who work with gloves or in contact with oil. Pull the ring nut to insert and extract the insert bit.

62036

MANDRINO DI BLOCCO SGANCIO RAPIDO

PORTAINSERTEI 1/4"E UNIVERSALE CON SFERE CONCENTRICHE DI TENUTA
BIT-HOLDER 1/4"E UNIVERSAL WITH CONCENTRIC HOLDING BALLS

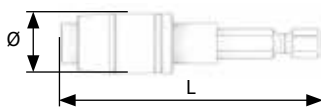

EASYPACK | sacchetto PVC con Euro-hole • PVC bags with Euro-hole

L mm	Ø mm	PCS.	COD.	€ cad./each
75	14	5	62036010	17,571
150	14	5	62036015	21,844
300	14	5	62036020	29,205



SELPACK
1 pc.

L mm	COD.	€ box
75	62036010001	19,055
150	62036015001	23,328
300	62036020001	30,689



FOCUS ON



Tre sfere bloccano saldamente l'inserto all'interno del mandrino. Questo prodotto è indicato anche come prolunga per meccie.
Three balls hold the insert firmly inside the spindle. This product is also suitable for use as a mechanical extension.

**62019**

MANDRINO DI BLOCCO SGANCIO RAPIDO

PORTAINSERTI CORPO RIDOTTO MAGNETICO 1/4" E CON MANDRINO, RAPIDO PER INSERTI 1/4" C
1/4" E MAGNETIC REDUCED BODY BIT-HOLDER WITH QUICK CHUCK FOR 1/4" C BITS

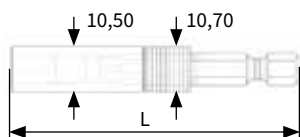

EASYPACK | sacchetto PVC con Euro-hole - PVC bags with Euro-hole

L mm	Ø mm	PCS.	COD.	€ cad./each
67	10,7	5	62019020	17,214



SELFPACK
1 pc.

L mm	COD.	€ box
67	62019020001	18,758



FOCUS ON

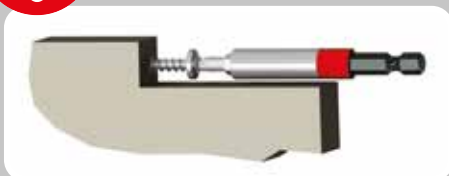

Corpo ridotto, sistema di bloccaggio e sgancio rapido dell'inserto. Ideale per spazi angusti o in caso di viti incassate.

Compact body, blocking and quick-release system of the bit. Ideal for small spaces or when using recessed screws.

62019

MANDRINO DI BLOCCO SGANCIO RAPIDO

PORTAINSERTI 1/4" E UNIVERSALE MAGNETICO CON MANDRINO E SGANCIO RAPIDO
UNIVERSAL MAGNETIC 1/4" E BIT-HOLDER WITH QUICK CHUCK

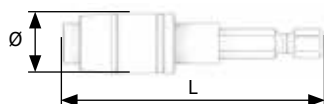

EASYPACK | sacchetto PVC con Euro-hole - PVC bags with Euro-hole

L mm	Ø mm	PCS.	COD.	€ cad./each
60	15	5	62019015	18,164



SELFPACK
1 pc.

L mm	COD.	€ box
60	62019015001	19,826



FOCUS ON



Meccanismo di trattenimento adatto a tutti gli attacchi da 1/4". Per bloccare l'inserto basta spingerlo nella cava del portainseriti, il mandrino si blocca automaticamente.

Retention mechanism suitable for all 1/4" attachments. To block the bit, simply push it into the slot of the bit-holder, the chuck will automatically lock into place.



1.3 PORTAINSERTI/ADATTATORI

BIT HOLDERS/ADAPTERS

62017

DOPPIO MAGNETE BATTUTA FISSA

PORTAINSERTI 1/4" E CON MAGNETE PER TRATTENIMENTO VITE PER INSERTE 1/4" C
1/4" E BIT-HOLDER WITH MAGNET FOR SCREW RETENTION FOR 1/4" C BITS

EASYPACK | sacchetto PVC con Euro-hole • PVC bags with Euro-hole



L mm	Ø mm	PCS.	COD.	€ cad./each
60	15	5	62017005	12,466

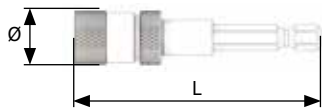

L mm	Ø mm	COD.	€ box
60	15	62017005001	14,009

SELPACK
1 pc.



FOCUS ON



Magnete ad anello per la testa della vite, profondità di avvitatura regolabile tramite la ghiera ideale per la messa in opera del cartongesso.

Ring magnets for the head of the screw, screwing depth can be adjusted via the ring nut, which makes it ideal for plasterboard.

62020

DOPPIO MAGNETE BATTUTA AUTO-REGOLANTE

PORTAINSERTI 1/4" E CON MAGNETE SCORREVOLE PER INSERTE 1/4" C
1/4" E BIT-HOLDER WITH SLIDING MAGNET FOR 1/4" C BITS

EASYPACK | sacchetto PVC con Euro-hole • PVC bags with Euro-hole



L mm	Ø mm	PCS.	COD.	€ cad./each
60	15	5	62020010	9,865
73	20	5	62020005*	15,671

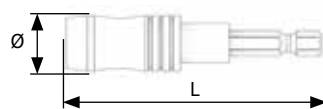

L mm	Ø mm	COD.	€ box
60	15	62020010001	11,456

SELPACK
1 pc.



FOCUS ON



Magnete ad anello per la testa della vite, la ghiera molleggiata si adatta a qualsiasi tipo di vite. L'articolo 62020005, con ghiera pivotante, è adatto all'uso con viti molto lunghe e pesanti.

Ring magnets for the head of the screw; the spring-loaded ring nut is suitable for any type of screw. Article 62020005, with pivoting ring nut, is suitable for very long and heavy screws.

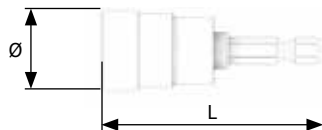
**62020****PER CARTONGESSO SISTEMA SMART-STOP****PORTAINSERTI PER CARTONGESSO CON FRIZIONE SMART-STOP 1/4" E PER INSERTI 1/4" C**
1/4" E BIT-HOLDER WITH SMART-STOP SYSTEM FOR DRY-WALL FOR 1/4" C BITS

EASYPACK | sacchetto PVC con Euro-hole - PVC bags with Euro-hole

L mm	Ø mm	PCS.	COD.	€ cad./each
58	25	1	62020015	20,064

**FOCUS ON**

Magnete ad anello per la testa della vite, la frizione di sgancio contenuta nel corpo di questo portainseriti garantisce una perfetta profondità di avvitatura a filo del piano.

Ring magnets for the screw head and the release friction contained in the body of this bit-holder guarantees perfect screwing depth, flush with the surface.

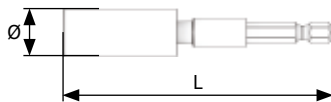
62086**ANTIGRAFFIO****PORTAINSERTI MAGNETICO ANTI-GRAFFIO 1/4" E PER INSERTI 1/4" C**
SCRATCH-RESISTANT MAGNETIC 1/4" E BIT-HOLDER FOR 1/4" C BITS

EASYPACK | sacchetto PVC con Euro-hole - PVC bags with Euro-hole

L mm	Ø mm	PCS.	COD.	€ cad./each
75	15	5	62086001	12,466

SELFPACK
1 pc.

L mm	COD.	€ box
75	62086001001	14,009

**FOCUS ON**

Il materiale antigraffio copre anche la testa della vite svolgendo anche funzione di bussola-guida. Per estrarre l'inserto far indietreggiare il canotto ed aiutarsi con una pinza.

The scratch-resistant material also covers the head of the screw, acting as a socket-guide. To extract the bit, push back the sleeve and pull it out with pliers.



1.3 PORTAINSERTI/ADATTATORI BIT HOLDERS/ADAPTERS

66031

DISPLAY DA BANCO

ESPOSITORE DA BANCO IN PLEXIGLASS PER 24 PEZZI
24 PCS. COUNTER PLEXIGLASS DISPLAY



24
pcs.

120 X 40 X 195 mm

COD. **66031008**
€ 197,568



6pcs.
COD. 62015010
6pcs.
COD. 62015015
6pcs.
COD. 62015020
6pcs.
COD. 62015030

COD. **66031014**
€ 413,199



24pcs.
COD. 62019015

COD. **66031009**
€ 124,992



12pcs.
COD. 62013005



6pcs.
COD. 62015015



6pcs.
COD. 62016005

COD. **66031015**
€ 283,369



24pcs.
COD. 62017005

COD. **66031011**
€ 222,244



24pcs.
COD. 62018010

COD. **66031016**
€ 225,530



24pcs.
COD. 62020010

COD. **66031012**
€ 336,672



24pcs.
COD. 62019010

COD. **66031017**
€ 285,899



24pcs.
COD. 62086001

COD. **66031013**
€ 391,749



24pcs.
COD. 62019020

COD. **66031018**
€ 468,518



24pcs.
COD. 62018005



66001

STORE 6 ASSORTIMENTI PORTAINSERTI

CASSETTIERA CON 6 SCOMPARTI PER ESPOSITORE MULTISTORE

DRAWERS WITH 6 COMPARTMENTS FOR MULTISTORE DISPLAY



600 X 115 X 65 mm

40
pcs.



COD. **66001120**

€ 329,246

<p>62013005 </p> <p> </p> <p>60mm 10pcs.</p>	<p>62015015 </p> <p> </p> <p>75mm 10pcs.</p>	<p>62015020 </p> <p> </p> <p>100mm 5pcs.</p>
<p>62016005 </p> <p> </p> <p>60mm 5pcs.</p>	<p>62017005 </p> <p> </p> <p>60mm 5pcs.</p>	<p>62018005 </p> <p> </p> <p>94mm 5pcs.</p>

MULTI STORE

COD. 66001005VC

PER DETTAGLI E COMPOSIZIONE VEDERE P. 184
FOR DETAILS AND COMPOSITION SEE P. 184

1.3



1.3 PORTAINSERTI/ADATTATORI

BIT HOLDERS/ADAPTERS

62016

MANDRINO DI BLOCCO

PORTAINSERTI 1/4"E CON MANDRINO DI BLOCCO PER INSERTI 1/4"C
 1/4"E BIT-HOLDER WITH CHUCK FOR 1/4"C BITS

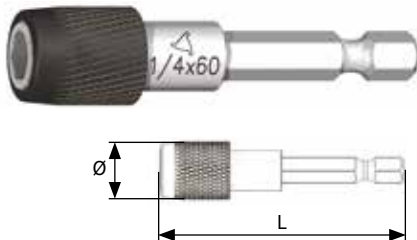

EASYPACK | sacchetto PVC con Euro-hole - PVC bags with Euro-hole

L mm	Ø mm	PCS.	COD.	€ cad./each
50	15	5	62016999	8,429



FOCUS ON

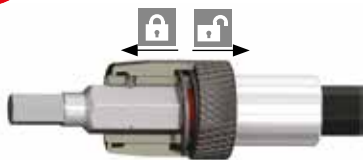

Le sfere di tenuta bloccano l'inserto: questo articolo è consigliato per l'uso con inserti esagonali che tendono a bloccarsi nella cava della vite.
The sealing balls block the insert: this article is recommended for using with hexagon bits that tend to stick in the slot of the screw.

62014

GUIDE PER BUSSOLE

PORTAINSERTI 1/4"E CON ANELLO C PER INSERTI 1/4"C - PER BUSSOLE GUIDA
 1/4"E BIT-HOLDER WITH C RING FOR 1/4"C BITS - FOR FINDER SLEEVES

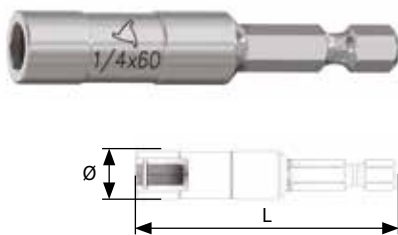

EASYPACK | sacchetto PVC con Euro-hole - PVC bags with Euro-hole

L mm	Ø mm	PCS.	COD.	€ cad./each
60	11	5	62014005	10,815



SELPACK
1 pc.

L mm	COD.	€ box
60	62014005001	12,466



TIPS



Portainseriti adatti all'utilizzo con inserti a taglio tipo lungo 61022 (p. 156) e bussole guida 61025 (p. 156).
Bit-holder suitable for use with long slotted bits, code 61022 (p. 156), and guide sockets, code 61025 (p. 156).

**62022**

ATTACCO SDS-PLUS

PORTAINSERTI SDS-PLUS® MAGNETICO CON ANELLO C PER INSERTI 1/4" C
MAGNETIC SDS-PLUS® BIT-HOLDER WITH C RING FOR 1/4" C BITS

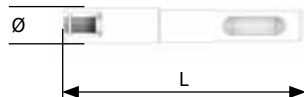

EASYPACK | sacchetto PVC con Euro-hole - PVC bags with Euro-hole

L mm	Ø mm	PCS.	COD.	€ cad./each
75	11	5	62022005	16,621

62024

ATTACCO 5/16" RAPIDO

PORTAINSERTI MAGNETICO CON ANELLO C 5/16" RAPIDO PER INSERTI 1/4" C
MAGNETIC 5/16" RAPID BIT-HOLDER WITH C RING FOR 1/4" C BITS



EASYPACK | sacchetto PVC con Euro-hole - PVC bags with Euro-hole

L mm	Ø mm	PCS.	COD.	€ cad./each
55	11	5	62024005	31,580

62011

ATTACCO 5,5 mm

PORTAINSERTI 5,5mm RAPIDO (A5,5) MAGNETICO CON ANELLO C PER INSERTI 1/4" C
MAGNETIC 5.5 mm (A5.5) RAPID BIT-HOLDER WITH C RING FOR 1/4" C BITS



EASYPACK | sacchetto PVC con Euro-hole - PVC bags with Euro-hole

L mm	Ø mm	PCS.	COD.	€ cad./each
72	11	5	62011005	25,169



1.3 PORTAINSERTI/ADATTATORI

BIT HOLDERS/ADAPTERS

64221

MINI-CRICCHETTI DOPPIA FUNZIONE

MINI-CRICCHETTO REVERSIBILE PER INSERTI 1/4" C E PER BUSSOLE 1/4"
 REVERSIBLE MINI-RATCHET FOR 1/4" C BITS AND 1/4" sockets

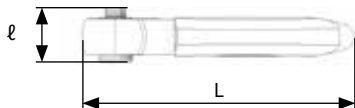

L mm	l mm	PCS.	COD.	€ cad./each
105	24	1	64221020	25,133

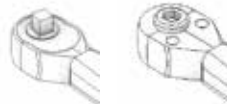

64221

MINI CRICCHETTO REVERSIBILE

MINI CRICCHETTO PORTAINSERTI REVERSIBILE PER INSERTI 1/4" C
 MINI REVERSIBLE RATCHET BIT-HOLDER FOR 1/4" C BITS

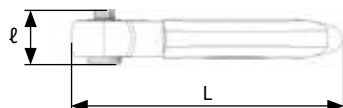

L mm	l mm	PCS.	COD.	€ cad./each
85	12,5	1	64221030001	24,763



**62032**

CHIAVI PORTAINSERTI

CHIAVE A 90° PORTAINSERTI 1/4" C
90° WRENCH 1/4" C BIT-HOLDER



EASYPACK | sacchetto PVC con Euro-hole - PVC bags with Euro-hole

L mm	ℓ mm	PCS.	COD.	€ cad./each
110	32	6	62032005	8,584

62033

CHIAVI PORTAINSERTI MAGNETICHE

CHIAVE A 90° PORTAINSERTI 1/4" C MAGNETICA
90° MAGNETIC 1/4" C BIT-HOLDER



EASYPACK | sacchetto PVC con Euro-hole - PVC bags with Euro-hole

L mm	ℓ mm	PCS.	COD.	€ cad./each
110	32	6	62033005	9,379

1.3



1.3 PORTAINSERTI/ADATTATORI BIT HOLDERS/ADAPTERS

62029

GIRAVITE PORTAINSERTI MAGNETICI

GIRAVITE MAGNETICO PER INSERTE 1/4" C
MAGNETIC SCREWDRIVER FOR 1/4" C BITS

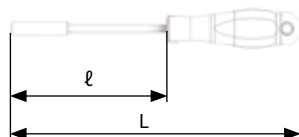

L mm	l mm	PCS.	COD.	€ cad./each
215	100	1	62029005	12,584



62029

GIRAVITE PORTAINSERTE A SGANCIO RAPIDO

GIRAVITE MAGNETICO PER INSERTE 1/4" C CON MANDRINO DI BLOCCO
MAGNETIC SCREWDRIVER FOR 1/4" C INSERTS WITH BLOCK SPINDLE



EASYPACK | sacchetto PVC con Euro-hole - PVC bags with Euro-hole

L mm	l mm	PCS.	COD.	€ cad./each
210	90	6	62029030	16,858

62029

GIRAVITE PORTAINSERTE MAGNETICI FLESSIBILI

GIRAVITE MAGNETICO FLESSIBILE PER INSERTE 1/4" C
FLEXIBLE MAGNETIC SCREWDRIVER FOR 1/4" C BITS

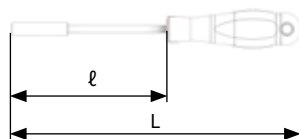

L mm	l mm	PCS.	COD.	€ cad./each
350	250	1	62029010	21,726

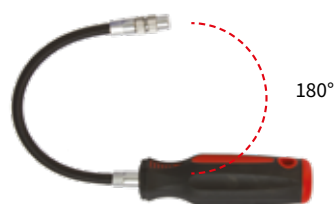

**62025**

ATTACCO QUADRO 1/4" CON SFERA

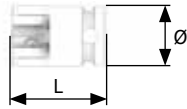
PORTAINSERTI 1/4" CON SFERA PER INSERTI 1/4"C**1/4" BIT-HOLDER WITH BALL FOR 1/4"C BITS**

EASYPACK| sacchetto PVC con Euro-hole - PVC bags with Euro-hole

L mm	Ø mm	PCS.	COD.	€ cad./each
25	12	1	62025010	3,502

62025

ATTACCO QUADRO 1/4" CON ANELLO

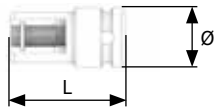
PORTAINSERTI 1/4" CON ANELLO C PER INSERTI 1/4"C**1/4" BIT-HOLDER WITH C RING FOR 1/4"C BITS**

EASYPACK| sacchetto PVC con Euro-hole - PVC bags with Euro-hole

L mm	Ø mm	PCS.	COD.	€ cad./each
30	13	1	62025005	7,954

SELFPACK
1 pc.

L mm	COD.	€ box
30	62025005001	9,545

62023

ATTACCO QUADRO 1/4" CON MANDRINO DI BLOCCO

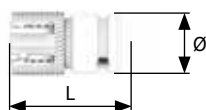
PORTAINSERTI 1/4" CON MANDRINO DI BLOCCO PER INSERTI 1/4"C**1/4" BIT-HOLDER WITH CHUCK FOR 1/4"C BITS**

EASYPACK| sacchetto PVC con Euro-hole - PVC bags with Euro-hole

L mm	Ø mm	PCS.	COD.	€ cad./each
32	15,5	1	62023005	19,114



1.3 PORTAINSERTI/ADATTATORI BIT HOLDERS/ADAPTERS

62027

ATTACCO QUADRO 3/8" CON SFERA

PORTAINSERTI CON SFERA 3/8" PER INSERTE 1/4"C
3/8" BIT-HOLDER WITH BALL FOR 1/4"C BITS

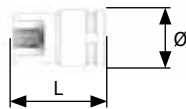

EASYPACK | sacchetto PVC con Euro-hole - PVC bags with Euro-hole

L mm	Ø mm	PCS.	COD.	€ cad./each
28	17	1	62027010	4,618

62027

ATTACCO QUADRO 3/8" CON ANELLO

PORTAINSERTI CON ANELLO C 3/8" PER INSERTE 1/4"C
3/8" BIT-HOLDER WITH C RING FOR 1/4"C BITS

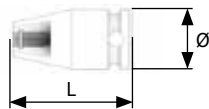

EASYPACK | sacchetto PVC con Euro-hole - PVC bags with Euro-hole

L mm	Ø mm	PCS.	COD.	€ cad./each
38	19	1	62027005	10,815

**62028**

ATTACCO QUADRO 3/8" CON MANDRINO DI BLOCCO

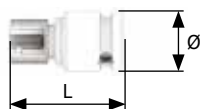
PORTAINSERTI CON MANDRINO DI BLOCCO 3/8" PER INSERTI 1/4"C**3/8" BIT-HOLDER WITH CHUCK FOR 1/4"C BITS**

EASYPACK | sacchetto PVC con Euro-hole • PVC bags with Euro-hole

L mm	Ø mm	PCS.	COD.	€ cad./each
37	19	1	62028005	26,712

62030

ATTACCO QUADRO 3/8" MAGNETICO CON ANELLO

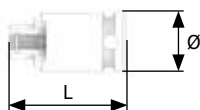
PORTAINSERTI 3/8" MAGNETICO CON ANELLO C PER INSERTI 1/4"C**MAGNETIC 3/8" BIT-HOLDER WITH C RING FOR 1/4"C BITS**

EASYPACK | sacchetto PVC con Euro-hole • PVC bags with Euro-hole

L mm	Ø mm	PCS.	COD.	€ cad./each
35	19	1	62030005	40,721



1.3 PORTAINSERTI/ADATTATORI BIT HOLDERS/ADAPTERS

62031

ATTACCO QUADRO 1/2" CON SFERA

PORTAINSERTI 1/2" CON SFERA PER INSERTI 1/4"C
1/2" BIT-HOLDER WITH BALL FOR 1/4"C BITS



EASYPACK | sacchetto PVC con Euro-hole - PVC bags with Euro-hole

L mm	Ø mm	PCS.	COD.	€ cad./each
38	22	1	62031010	6,043

62031

ATTACCO QUADRO 1/2" CON ANELLO

PORTAINSERTI 1/2" CON ANELLO C PER INSERTI 1/4"C
1/2" BIT-HOLDER WITH C RING FOR 1/4"C BITS

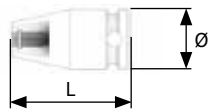

EASYPACK | sacchetto PVC con Euro-hole - PVC bags with Euro-hole

L mm	Ø mm	PCS.	COD.	€ cad./each
35	24	1	62031015	14,840

62031

ATTACCO QUADRO 1/2" CON MANDRINO DI BLOCCO

PORTAINSERTI 1/2" CON MANDRINO DI BLOCCO PER INSERTI 1/4"C
1/2" BIT-HOLDER WITH CHUCK FOR 1/4"C BITS

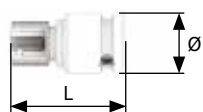

EASYPACK | sacchetto PVC con Euro-hole - PVC bags with Euro-hole

L mm	Ø mm	PCS.	COD.	€ cad./each
45	25	1	62031005	26,949



COME SCEGLIERE IL PORTAINSERTO

HOW TO CHOOSE A BIT HOLDER

NON MAGNETICI

Non-magnetic

RECOMMENDED



Quando si lavora in presenza di limatura, polvere o trucioli d ferro.
For working in the presence of filings, dust or iron shavings.

DOPPIO MAGNETE

Double magnets

RECOMMENDED



Con viti di grosse dimensioni o lunghe (viti per coperture edilizie).
With large or long screws (screws for building roofs).

SGANCIO RAPIDO

Quick release

RECOMMENDED



Se si devono indossare guanti, o se le mani sono sporche di olio.
If you have to wear gloves or if your hands are oily.

SNODATI O FLESSIBILI

Jointed or flexible

RECOMMENDED



Vicino ad uno spigolo (zoccolini, mobili, cassetti, motori di auto, parafanghi).
Close to an edge (skirting boards, furniture, drawers, car engines, mudguards).

MANDRINO DI BLOCCO

Chuck

RECOMMENDED



Se l'inserto si blocca nella cava della vite, se il punto in cui va posizionata la vite è difficilmente raggiungibile.

If the bit becomes stuck in the slot of the screw, if the point where the screw is to be positioned is difficult to reach.

BUSSOLE MAGNETICHE

Magnetic sockets

RECOMMENDED



In caso di fori profondi o alloggiamenti particolarmente stretti.
In case of deep holes or particularly tight seats.

1.3



1.3 PORTAINSERTI/ADATTATORI BIT HOLDERS/ADAPTERS

62019

MANDRINO DI BLOCCO SGANCIO RAPIDO

PORTAINSERTI 1/4" E UNIVERSALE MAGNETICO CON MANDRINO E SGANCIO
UNIVERSAL MAGNETIC 1/4" E BIT-HOLDER WITH QUICK CHUCK

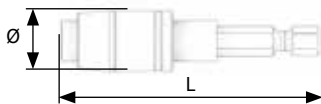

EASYPACK | sacchetto PVC con Euro-hole - PVC bags with Euro-hole

L mm	Ø mm	PCS.	COD.	€ cad./each
60	15	5	62019015	18,164



SELPACK
1 pc.

L mm	COD.	€ box
60	62019015001	19,826



FOCUS ON



Meccanismo di trattenimento adatto a tutti gli attacchi da 1/4". Per bloccare l'inserto basta spingerlo nella cava del portainseriti, il mandrino si blocca automaticamente.

Retention mechanism suitable for all 1/4" attachments. To block the bit, simply push it into the slot of the bit-holder, the chuck will automatically lock into place.

62055

SUPER-FLESSIBILI

PORTAINSERTI 1/4" E SUPER-FLESSIBILE PER LAME 1/4" E
EXTRA-FLEXIBLE 1/4" E BIT-HOLDER FOR FOR 1/4" E POWER BITS

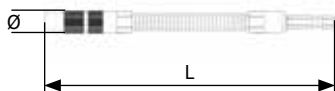

EASYPACK | sacchetto PVC con Euro-hole - PVC bags with Euro-hole

L mm	Ø mm	PCS.	COD.	€ cad./each
300	16	1	62055005	63,386



FOCUS ON

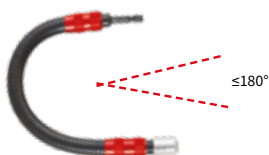

Grazie all'estrema flessibilità si presta a lavorare in spazi difficilmente raggiungibili.

Its extreme flexibility is perfect for working in difficult positions or to reach narrow spaces.

**62029**

IMPUGNATURE PORTAINSERTI

IMPUGNATURA CON SFERA PER LAME 1/4" E
HANDLE WITH BALL FOR 1/4" E POWER-BITS

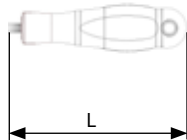

EASYPACK | sacchetto PVC con Euro-hole - PVC bags with Euro-hole

L mm	PCS.	COD.	€ cad./each
125	1	62029015	11,991

62051

ATTACCO QUADRO 3/8" CON SFERA

PORTAINSERTI 3/8" CON SFERA PER LAME 1/4" E
3/8" BIT-HOLDER WITH BALL FOR 1/4" E POWER-BITS

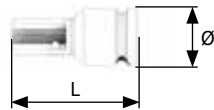

EASYPACK | sacchetto PVC con Euro-hole - PVC bags with Euro-hole

L mm	Ø mm	PCS.	COD.	€ cad./each
42	19	1	62051005	37,867

62054

ATTACCO QUADRO 3/8" CON MANDRINO DI BLOCCO

PORTAINSERTI 3/8" CON MANDRINO DI BLOCCO PER LAME 1/4" E
3/8" BIT-HOLDER WITH CHUCK FOR 1/4" C POWER-BITS

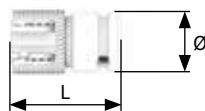

EASYPACK | sacchetto PVC con Euro-hole - PVC bags with Euro-hole

L mm	Ø mm	PCS.	COD.	€ cad./each
42	19	1	62054006*	85,142
55	19	1	62054005	44,100

* IMPACT

RINVII ANGOLARI

RINVII ANGOLARI PER INSERTI 1/4" C E LAME 1/4" E
Angle heads for 1/4" C bits and 1/4" E power-bits

INDUSTRIAL

1

Ingranaggi del giunto con coppia conica ipoide.

Gear coupling with hypoid bevel gear pair.

2

Guide dell'albero temprate e rettificate.

Hardened and ground shaft guide.

3

Resistenza allo sforzo di torsione garantita oltre a 65 Nm.

Resistance to torsional stress is guaranteed at over 65 Nm.



TIPS

Non utilizzare con avvitatori ad impulsi
Do not use with impact wrenches

PROFESSIONAL

1

Ingranaggi del giunto con coppia conica semplice.

Gear coupling with simple bevel gear pair.

2

Testa ribassata, manico pivottante e/o estraibile.

Low-rise head, pivoting and/or extractable handle.

3

Resistenza allo sforzo di torsione garantita fino a 40 Nm.

Resistance to torsional stress is guaranteed up to 40 Nm.



TIPS

Non utilizzare con avvitatori ad impulsi
Do not use with impact wrenches

62034**RINVII ANGOLARI 90° INDUSTRIALI****RINVIO ANGOLARE 90° PER INSERTI 1/4" C - ALTA RESISTENZA - INDUSTRIALE****90° ANGLE DRIVER FOR 1/4" C BITS - HIGH RESISTANCE - INDUSTRIAL****65 Nm**

L mm	ℓ mm	PCS.	COD.	€ cad./each
125	41	1	62034006	70,963

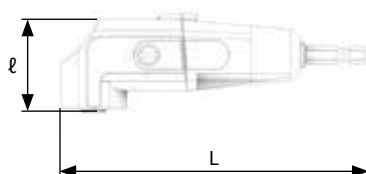

77 X 175 mm

**FOCUS ON**

Cuscinetti di alta qualità, alberi temprati rettificati, coppia conica ipoide per una rotazione fluida. Utensile adatto ad usi industriali intensivi. Facile manutenzione.

High quality bearings, ground tempered shafts, hypoid bevel coupling for smooth rotation. Tool suitable for heavy-duty industrial use. Easy maintenance.

62034**MINI RINVII ANGOLARI 90° PROFESSIONALI****RINVIO ANGOLARE 90° CON MANDRINO DI BLOCCO PER INSERTI 1/4" C****90° ANGLE DRIVER WITH CHUCK FOR 1/4" C BITS****40 Nm**

L mm	ℓ mm	PCS.	COD.	€ cad./each
83	46	1	62034010	42,874

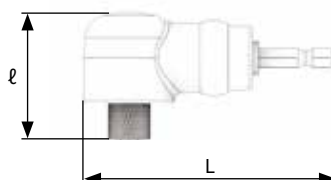

85 X 190 mm

**FOCUS ON**

Pratico e compatto con manico pivotante e serrabile in 8 diverse posizioni viene fornito con un inserto PH2x25, confezionato in blister.

Compact and practical, with pivoting handle that can be locked in eight different positions. Comes with a PH2x25 bit in a blister pack.



1.3 PORTAINSERTI/ADATTATORI BIT HOLDERS/ADAPTERS

62034

RINVII ANGOLARI 90° PROFESSIONALI

RINVIO ANGOLARE 90° CON TESTA RIBASSATA PER INSERTI 1/4" C

90° ANGLE HEAD WITH LOW-RISE HEAD FOR 1/4" BITS

40 Nm

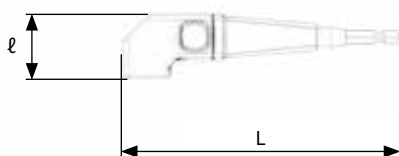

L mm	l mm	PCS.	COD.	€ cad./each
136	32	1	62034020	55,440



80 X 185 mm



FOCUS ON

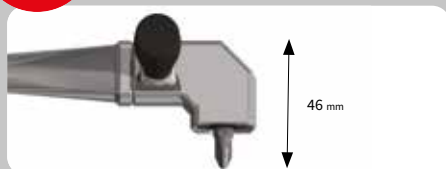

Testa ribassata per raggiungere le posizioni più difficili. Leggero e maneggevole grazie alla scocca in alluminio. Manico dotato di serbatoio per inserti.

Low-rise head to reach the most difficult positions. Lightweight and easy to handle thanks to its aluminium body. Handle equipped with bit container.

62053

RINVII ANGOLARI 90° PROFESSIONALI PER LAME 1/4"E

RINVIO ANGOLARE 90° CON MANDRINO DI BLOCCO PER LAME 1/4"E

90° ANGLE DRIVE WITH CHUCK FOR 1/4" C POWER-BITS

40 Nm

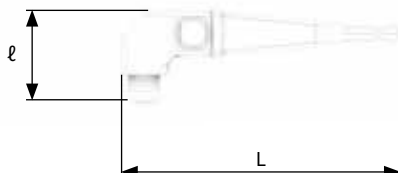

L mm	l mm	PCS.	COD.	€ cad./each
136	47	1	62053006	72,688



90 X 185 mm



FOCUS ON



Mandrino di blocco per lame 1/4"E. Leggero e maneggevole grazie alla scocca in alluminio. Manico dotato di serbatoio per inserti.

Chuck for 1/4" E power bits. Lightweight and easy to handle thanks to its aluminium body. Handle equipped with bit container.

**62034**

RINVII ANGOLARI 80° PROFESSIONALI

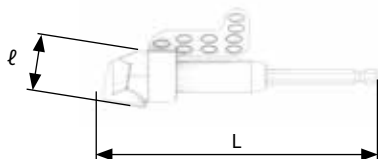
RINVIO ANGOLARE 80° PER INSERTI 1/4" C
80° ANGLE DRIVER FOR 1/4" C BITS**20 Nm**

L mm	ℓ mm	PCS.	COD.	€ cad./each
138	27	1	62034025	20,328



95 X 167 mm

1.3**62034**

RINVII ANGOLARI 80° CON IMPUGNATURA

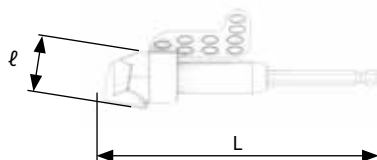
RINVIO ANGOLARE 80° CON IMPUGNATURA ESTRAIBILE PER INSERTI 1/4" C
80° ANGLE DRIVER WITH EXTRACTABLE HANDLE FOR 1/4" C BITS**20 Nm**

L mm	ℓ mm	PCS.	COD.	€ cad./each
138	27	1	62034015	32,771



110 X 300 mm

**FOCUS ON**Ridotte dimensioni della testa, manico sfilabile.
Compact head size, removable handle.

ADATTATORI

ADATTATORI PER BUSSOLE 1/4" C E 1/4" E
Adapters for 1/4" C and 1/4" E sockets

A = secondo DIN 3121 Forma E, con perno di trattenimento in acciaio per molle. Indicati per l'utilizzo con bussole IMPACT; il perno assicura il bloccaggio della bussola evitandone la perdita anche su impianti automatici.

A = according to DIN 3121 Form E Standard, with retention pin in spring steel. Suitable for use with IMPACT sockets; the pin ensures the locking of the socket, preventing loss even on automatic systems.

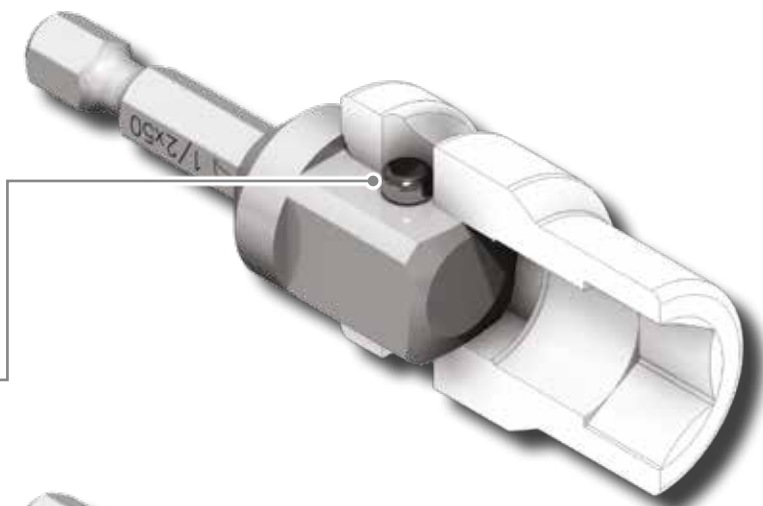

B = secondo DIN 3120 Forma A, con sfera in acciaio. Indicati per l'utilizzo con bussole CHROME; la sfera favorisce il montaggio e lo smontaggio della bussola.

B = according to DIN 3120 Form A Standard, with steel ball. Suitable for use with CHROME sockets; the ball facilitates assembly and disassembly of the socket.

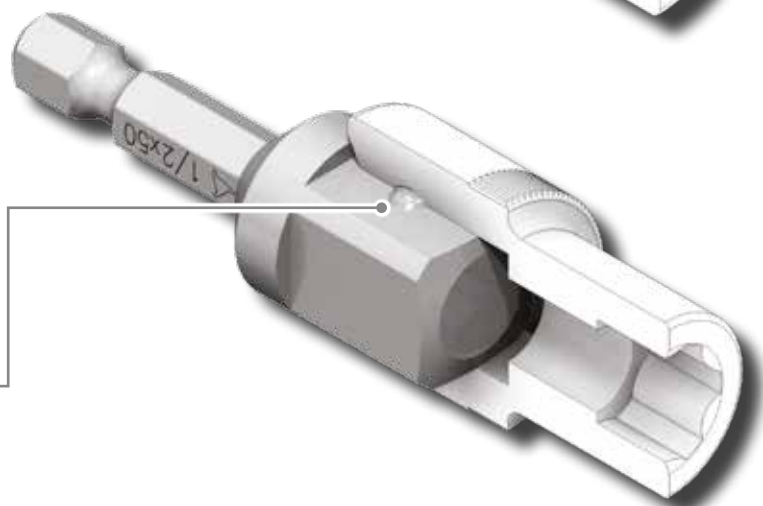

Realizzati con lo stesso acciaio di alta qualità utilizzato per gli inserti che offre un ottimo equilibrio tra durezza e tenacità.

Made with the same high-quality steel used for the bits, which provides an excellent combination of hardness and toughness.



Progettati per il massimo rendimento in coppia con le bussole IMPACT e CHROME della gamma LTI.

Designed for maximum performance in combination with IMPACT and CHROME sockets from the LTI range.



La gamma comprende anche la versione con attacco SDS PLUS in uso sui trapani martellatori per edilizia.

The range also includes the version with SDS PLUS attachment for use on hammer drills in the construction industry.

**62100****ADATTATORI 1/4" C PER BUSSOLE 1/4"****ADATTATORE 1/4" C PER BUSSOLE 1/4"**
1/4" C ADAPTER FOR 1/4" SOCKETS

EASYPACK | sacchetto PVC con Euro-hole - PVC bags with Euro-hole

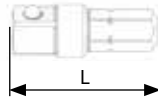
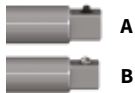

L mm	A/B	PCS.	COD.	€ cad./each
25	B	5	62100005	3,302

1.3

62101**ADATTATORI 1/4" E PER BUSSOLE 1/4"****ADATTATORE 1/4" E PER BUSSOLE 1/4"**
1/4" E ADAPTER FOR 1/4" SOCKETS

EASYPACK | sacchetto PVC con Euro-hole - PVC bags with Euro-hole

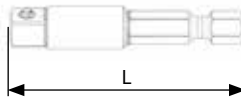

L mm	A/B/C	PCS.	COD.	€ cad./each
35	A	5	62101003	12,209
50	A	5	62101005	4,952
50	B	5	62101010	4,952
75	A	1	62101025	12,566
100	A	1	62101015	13,059
100	B	1	62101020	13,059
150	A	1	62101030	36,344
200	A	1	62101035	56,179

SELPACK
1 pc.

L mm	A/B	COD.	€ box
50	B	62101010001	6,603



1.3 PORTAINSERTI/ADATTATORI BIT HOLDERS/ADAPTERS

62111

ADATTATORI 1/4"E PER BUSSOLE 3/8"

ADATTATORE 1/4"E PER BUSSOLE 3/8"
1/4"E ADAPTER FOR 3/8" SOCKETS

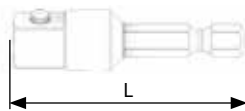

EASYPACK | sacchetto PVC con Euro-hole - PVC bags with Euro-hole

L mm	A/B	PCS.	COD.	€ cad./each
50	A	5	62111005	5,938
50	B	5	62111010	5,938
75	A	1	62111020	21,447
100	A	1	62111015	21,447
150	A	1	62111025	52,789
200	A	1	62111030	62,688



SELPACK
1 pc.

L mm	A/B	COD.	€ box
50	B	62111010001	7,589

62121

ADATTATORI 1/4"E PER BUSSOLE 1/2"

ADATTATORE 1/4"E PER BUSSOLE 1/2"
1/4"E ADAPTER FOR 1/2" SOCKETS

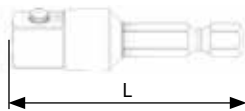

EASYPACK | sacchetto PVC con Euro-hole - PVC bags with Euro-hole

L mm	A/B	PCS.	COD.	€ cad./each
50	A	1	62121005	8,747
50	B	1	62121006	8,747



SELPACK
1 pc.

L mm	A/B	COD.	€ box
50	B	62121006001	10,398

1/4"

3/8"

1/2"

62103**ADATTATORI SDS PLUS® PER BUSSOLE 1/4"****ADATTATORE SDS-PLUS® PER BUSSOLE 1/4"**

SDS PLUS® ADAPTER FOR 1/4" SOCKETS

1/4"



EASYPACK | sacchetto PVC con Euro-hole - PVC bags with Euro-hole

L mm	A/B	PCS.	COD.	€ cad./each
57	B	1	62103005	12,209

62113**ADATTATORI SDS PLUS® PER BUSSOLE 3/8"****ADATTATORE SDS-PLUS® PER BUSSOLE 3/8"**

SDS PLUS® ADAPTER FOR 3/8" SOCKETS

3/8"

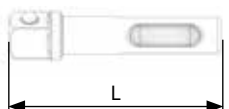

EASYPACK | sacchetto PVC con Euro-hole - PVC bags with Euro-hole

L mm	A/B	PCS.	COD.	€ cad./each
60	B	1	62113005	12,702

62122**ADATTATORI SDS PLUS® PER BUSSOLE 1/2"****ADATTATORE SDS-PLUS® PER BUSSOLE 1/2"**

SDS PLUS® ADAPTER FOR 1/2" SOCKETS

1/2"

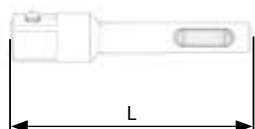

EASYPACK | sacchetto PVC con Euro-hole - PVC bags with Euro-hole

L mm	A/B	PCS.	COD.	€ cad./each
65	B	1	62122005	14,045



1.3 PORTAINSERTI/ADATTATORI BIT HOLDERS/ADAPTERS

62102

ADATTATORI 5/16" RAPIDO PER BUSSOLE 1/4"

ADATTATORE 5/16" RAPIDO PER BUSSOLE 1/4"

QUICK 5/16" ADAPTER FOR 1/4" SOCKETS

EASYPACK | sacchetto PVC con Euro-hole - PVC bags with Euro-hole



L mm	A/B	PCS.	COD.	€ cad./each
50	A	1	62102005	19,219

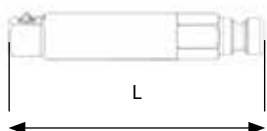

62112

ADATTATORI 5/16" RAPIDO PER BUSSOLE 3/8"

ADATTATORE 5/16" RAPIDO PER BUSSOLE 3/8"

QUICK 5/16" ADAPTER FOR 3/8" SOCKETS

EASYPACK | sacchetto PVC con Euro-hole - PVC bags with Euro-hole



L mm	A/B	PCS.	COD.	€ cad./each
50	A	1	62112005	37,117

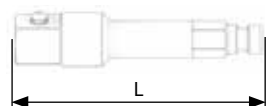

62114

ADATTATORI 7/16" RAPIDO PER BUSSOLE 3/8"

ADATTATORE 7/16" RAPIDO PER BUSSOLE 3/8"

QUICK 7/16" ADAPTER FOR 3/8" SOCKETS

EASYPACK | sacchetto PVC con Euro-hole - PVC bags with Euro-hole



L mm	A/B	PCS.	COD.	€ cad./each
70	A	1	62114005	32,665

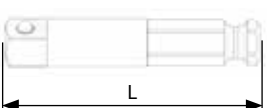



62601

ASSORTIMENTO 3 ADATTATORI

ASSORTIMENTO 3 ADATTATORI PER BUSSOLE 1/4", 3/8" E 1/2"

3 PCS. ADAPTERS SET FOR 1/4", 3/8" AND 1/2" SOCKETS



EASYPACK | sacchetto PVC con Euro-hole - PVC bags with Euro-hole

A/B	PCS.	COD.	€ cad./each
B	1	62601001	8,131



95 X 145 mm



EURO-HOLE

1.3

65011

MAGNETIZZATORI SMAGNETIZZATORI

BLOCCHETTO MAGNETIZZATORE / SMAGNETIZZATORE PER GIRAVITE

MAGNETIZER / DEMAGNETIZER FOR SCREWDRIVERS



EASYPACK | sacchetto PVC con Euro-hole - PVC bags with Euro-hole

L mm	ℓ mm	PCS.	COD.	€ cad./each
54	49	1	65011005	11,765



FOCUS ON



Ideale per magnetizzare temporaneamente giravite e lame di avvitatura. Inserire la punta nell'apposita fessura per alcuni secondi. Per smagnetizzare inserire la punta nell'altra fessura.

Ideal to temporarily magnetize screwdrivers and screwing blades. Insert the tip into the slot for a few seconds. To demagnetize, insert the tip into the other slot.

1.3 PORTAINSERTI/ADATTATORI

BIT HOLDERS/ADAPTERS

65011

BUSSOLE MAGNETICHE PER LAME O GIRAVITE

BUSSOLA MAGNETICA EXTRA-FORTE PER GIRAVITE E LAME
EXTRA-STRONG MAGNETIC SOCKET FOR SCREWDRIVERS AND POWER BITS

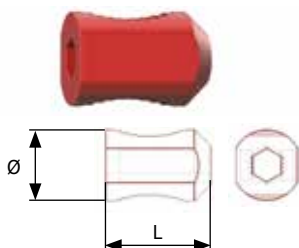

EASYPACK | sacchetto PVC con Euro-hole - PVC bags with Euro-hole

L mm	Ø mm	PCS.	COD.	€ cad./each
27	16	1	65011010	10,020



70 X 120 mm



FOCUS ON

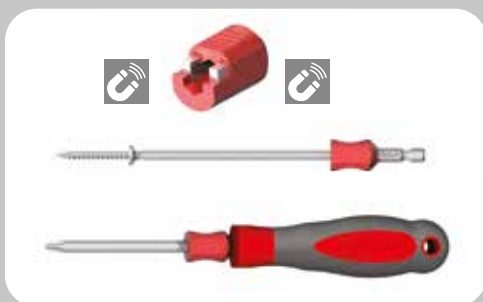

Diametro foro 7mm, doppio magnete, trattenimento fino a 400 gr. Agisce anche a 12cm dalla vite. Si consiglia di forzare la bussola sull'attacco esagonale per assicurarne la posizione. Indicato anche per giravite con lama fino a diametro 7.

Hole diameter of 7 mm, two magnets, retention up to 400 g. Also acts at a distance of up to 12cm from the screw. Recommended for mounting the socket onto the hexagon attachment to ensure its position. Suitable also for screwdrivers with minimum blade diameter of 7.

65011

PINZA PORTA-VITE PER VITI INOX

PINZA PORTA-VITE PER VITI INOX
SCREW HOLDER FOR STAINLESS STEEL SCREWS



EASYPACK | sacchetto PVC con Euro-hole - PVC bags with Euro-hole

Ø	PCS.	COD.	€ cad./each
10	1	65011020	2,137



FOCUS ON



Applicata sul portainseriti permette di trattenere sull'inserto viti che non possono essere trattenute da sistemi magnetici.

Applied on the bit holder it allows to retain on the insert screws that cannot be retained by magnetic systems.

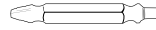
**66037****FastOut SET ESTRATTORI PER VITI****ASSORTIMENTO 4 PCS. ESTRATTORI PER VITI DANNEGGIATE**
SET OF 4 EXTRACTORS FOR DAMAGED SCREWS4
pcs.COD. **66037010****€ 18,726**

No. 4 - No. 7 1pc.	No. 8 - No. 10 1pc.	No. 11 - No. 14 1pc.	No. 16 - No. 24 1pc.
-----------------------	------------------------	-------------------------	-------------------------

1.3

61130**INSERTI ESTRATTORI PER VITI****INSERTI FORATORI/ESTRATTORI PER VITI DANNEGGIATE**
DRILL/EXTRACTOR BITS FOR DAMAGED SCREWS**60/62 HRC****EASYPACK** | sacchetto PVC con Euro-hole • PVC bags with Euro-hole

Ø mm	L mm	PCS.	COD.	€ cad./each
1	50	10	61130105	3,920
2	50	10	61130110	3,920
3	50	10	61130115	3,920
4	50	10	61130120	3,920



Il capitolo 2 è dedicato alle tipologie di inserti più speciali ed indicati per campi di applicazione particolari come il settore industriale, quello meccanico o dell'elettronica. In questi ambiti vengono infatti richiesti anche inserti ed accessori con attacchi differenti da quello presentato nel primo capitolo. Il reparto di produzione interno, dotato di moderne macchine per la lavorazione ed il trattamento termico, ci permette inoltre di studiare e realizzare utensili secondo le specifiche indicate dal cliente stesso. Sono ormai migliaia i codici di inserti ed accessori speciali che abbiamo fabbricato per clienti di tutto il mondo.

















Chapter 2 is devoted to specific types of bits, manufactured expressly for special applications in the industrial, mechanical, electronic or precision sectors. In fact, these sectors require bits and accessories with attachments and tips different from those presented in the first chapter. Our internal production department, equipped with modern machinery for machining and heat treatments, allows us to design and create tools according to customer specifications. We produce thousands of special bits and accessories for our customers around the world.

















2

INSERTI E CHIAVI SPECIALI SPECIAL BITS AND SETTERS

INSERTI SPECIALI SPECIAL BITS

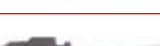
		INSERTI 10mm (3/8") 10mm (3/8") BITS	p. 240
		INSERTI 5/16" C 5/16" C BITS	p. 246
		INSERTI 4mm 4mm BITS	p. 251
		INSERTI 4MA 4MA BITS	p. 258
		INSERTI 5MA 5MA BITS	p. 260
		INSERTI 6MA 6MA BITS	p. 262
		INSERTI 10x32 UNF 10x32 UNF BITS	p. 264
		INSERTI 3/16x32 3/16x32 BITS	p. 266
		LAME 7/16" RAPIDO 7/16" QUICK POWER BITS	p. 267
		LAME 5/16" RAPIDO 5/16" QUICK POWER BITS	p. 268
		LAME 3mm 3mm POWER BITS	p. 270
		LAME A SPINA TROUGH HOLE POWER BITS	p. 270
		INSERTI DOPPI D.7mm D.7mm DOUBLE	p. 271

CHIAVI SPECIALI SPECIAL SETTERS

		CHIAVI AVVITABUSSOLE SCREW-IN TOOL FOR COUPLING SLEEVE	p. 272
		CHIAVI AVVITAPRIGIONIERI INTERNAL TRHEAD INSERTION TOOL	p. 273
		CHIAVI PORTA PUNTE/MASCHI DRILL/TAP SETTERS	p. 274
		CHIAVI PER CERNIERE ANUBA KEY-LOCKS FOR ANUBA HINGENS	p. 275
		CHIAVI PORTAMANDRINI CHUCK ADAPTERS	p. 276
		SDS-MAX/SDS-PLUS	p. 277
		RINVIO PER TRAPANI ANGLE DRIVER FOR DRILLS	p. 277

SPECIALI

INSERTI E CHIAVI SPECIALI PER L'INDUSTRIA, L'AUTOMAZIONE E LA MANUTENZIONE

Special bits and setters for the industrial, automation and maintenance sectors.

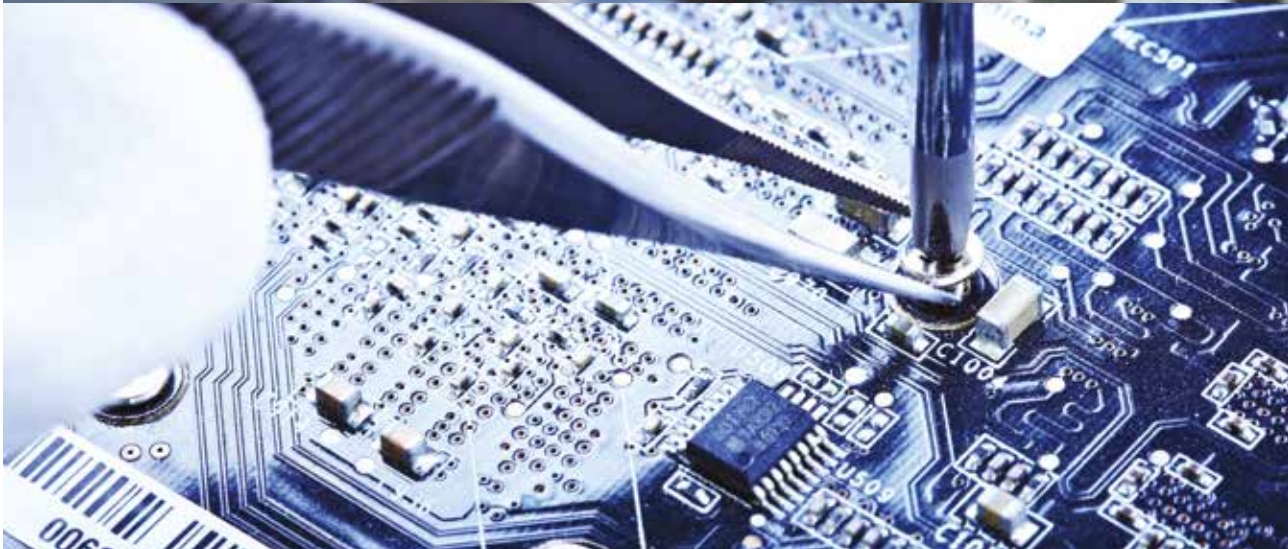

1

Nel campo meccanico, per la produzione e riparazione di motori, e nella cantieristica, ambiti nei quali è necessario l'uso di fasteners di diametri elevati e a massime prestazioni, vengono utilizzati inserti con attacco maggiorato ed impronte a 6 e 12 lobi che permettano una migliore distribuzione della coppia di serraggio. Un appropriato acciaio al Cromo Silicio Vanadio garantisce una elevata resistenza ed una maggiore elasticità.

Bits with larger attachments and tips with 6 and 12 lobes, which provide better distribution of the tightening torque, are commonly used in the mechanical industry for the production and repair of engines, and in shipbuilding yards. These areas require the use of fasteners with wide diameters and high performances. Chrome-silicon-vanadium steel guarantees high resistance and greater elasticity.

2

I dispositivi elettronici sono ormai nelle mani di tutti e, con loro, le micro viti sono largamente diffuse. Prerogativa di questo tipo di fasteners è l'estrema precisione: è molto facile rovinare l'impronta o il filetto. Per questo tipo di applicazioni abbiamo selezionato una serie di inserti con le impronte più comuni, realizzati con un acciaio apposito, estremamente tenace, per evitare deformazioni del l'impronta che possano danneggiare la cava della vite.

Suitable for the production of electronic devices where micro-screws are widely used. The special feature of this type of fastener is its extreme precision: it is very easy to ruin the tip or thread. For these types of applications, we selected a series of bits with more common tips, made with special, extremely strong, steel to prevent deformations of the tip that might damage the slot of the screw.

3

La produzione di utensili per applicazioni industriali e per impianti di assemblaggio automatizzati è sicuramente un settore nel quale il marchio LTI si è da sempre contraddistinto. Grazie a questa nostra specificità, da sempre apprezzata dai nostri clienti, ogni due giorni introduciamo un nuovo codice prodotto. Abbiamo quindi selezionato una gamma di utensili industriali sempre disponibili a magazzino e con un prezzo di listino fisso a prescindere dalla quantità, ponendo la massima attenzione alla qualità per garantire la massima affidabilità.

The LTI brand has always been a pioneer in the production of tools for industrial applications and for automated assembly systems. For this case, we also offer a range of industrial tools that are always in stock, placing maximum attention on the construction to guarantee maximum reliability.



2 INSERTI E CHIAVI SPECIALI

BITS AND SPECIAL SETTERS

61011

ESAGONO 10mm (3/8")

INSERTI 10mm (3/8") ESAGONALI PER MECCANICA
 10mm (3/8") HEX BITS FOR MECHANICS

56/58 HRC

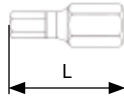

EASYPACK | sacchetto PVC con Euro-hole - PVC bags with Euro-hole

	L mm	PCS.	COD.	€ cad./each
4	30	5	61011005	1,733
	75	5	61011010	3,014
5	30	5	61011015	1,733
	75	5	61011020	3,014
6	30	5	61011025	1,733
	75	5	61011030	3,014
7	30	5	61011035	1,733
	75	5	61011040	3,014
8	30	5	61011045	1,733
	75	5	61011050	3,014
10	30	5	61011055	1,733
	75	5	61011060	3,014
12	30	5	61011065	2,208
	75	5	61011070	3,679
14	30	5	61011075	2,570
	75	5	61011080	3,840

61129

XZN - 10mm (3/8")

INSERTI 10mm (3/8") PER VITI XZN PER MECCANICA
 10mm (3/8") BITS FOR XZN MECHANICAL SCREWS

56/58 HRC

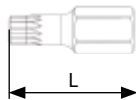

EASYPACK | sacchetto PVC con Euro-hole - PVC bags with Euro-hole

	L mm	PCS.	COD.	€ cad./each
M5	30	5	61129005	2,026
	75	5	61129010	3,245
M6	30	5	61129015	2,026
	75	5	61129020	3,245
M8	30	5	61129025	2,026
	75	5	61129030	3,245
M10	30	5	61129035	2,026
	75	5	61129040	3,245
M12	30	5	61129045	2,429
	75	5	61129050	3,921
M14	30	5	61129055	2,842
	75	5	61129060	4,325

**61100****TX - 10mm (3/8")****INSERTI 10mm (3/8") PER VITI TORX® PER MECCANICA**

10mm (3/8") BITS FOR TORX® MECHANICAL SCREWS

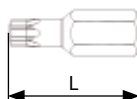
56/58 HRC

EASYPACK | sacchetto PVC con Euro-hole - PVC bags with Euro-hole

	L mm	PCS.	COD.	€ cad./each
TX10	30	5	61100005	1,764
	75	5	61100010	2,974
TX15	30	5	61100015	1,764
	75	5	61100020	2,974
TX20	30	5	61100025	1,764
	75	5	61100030	2,974
TX25	30	5	61100035	1,764
	75	5	61100040	2,974
TX27	30	5	61100045	1,764
	75	5	61100050	2,974
TX30	30	5	61100055	1,764
	75	5	61100060	2,974
TX40	30	5	61100065	1,764
	75	5	61100070	2,974
TX45	30	5	61100075	1,764
	75	5	61100080	2,974
TX50	30	5	61100085	1,764
	75	5	61100090	2,974
TX55	30	5	61100095	1,764
	75	5	61100100	2,974

61114**TXH - 10MM (3/8")****INSERTI 10mm (3/8") PER VITI TORX® CON FORO PER MECCANICA**

10mm (3/8") BITS FOR TORX® MECHANICAL SCREWS WITH HOLE

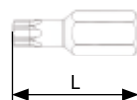
56/58 HRC

EASYPACK | sacchetto PVC con Euro-hole - PVC bags with Euro-hole

	L mm	PCS.	COD.	€ cad./each
TXH10	30	5	61114005	2,299
	75	5	61114010	3,518
TXH15	30	5	61114015	2,299
	75	5	61114020	3,518
TXH20	30	5	61114025	2,299
	75	5	61114030	3,518
TXH25	30	5	61114035	2,299
	75	5	61114040	3,518
TXH27	30	5	61114045	2,299
	75	5	61114050	3,518
TXH30	30	5	61114055	2,299
	75	5	61114060	3,518
TXH40	30	5	61114065	2,299
	75	5	61114070	3,518
TXH45	30	5	61114075	2,299
	75	5	61114080	3,518
TXH50	30	5	61114085	2,299
	75	5	61114090	3,518
TXH55	30	5	61114095	2,299
	75	5	61114100	3,518



2 INSERTI E CHIAVI SPECIALI

BITS AND SPECIAL SETTERS

61128

RIBE - 10mm (3/8")

INSERTI 10mm (3/8") PER VITI RIBE® PER MECCANICA

10mm (3/8") BITS FOR RIBE® MECHANICAL SCREWS

56/58 HRC

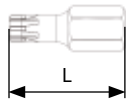

EASYPACK | sacchetto PVC con Euro-hole - PVC bags with Euro-hole

	L mm	PCS.	COD.	€ cad./each
M4	30	5	61128005	2,026
	75	5	61128010	3,245
M5	30	5	61128015	2,026
	75	5	61128020	3,245
M6	30	5	61128025	2,026
	75	5	61128030	3,245
M7	30	5	61128035	2,026
	75	5	61128040	3,245
M8	30	5	61128045	2,026
	75	5	61128050	3,245
M9	30	5	61128055	2,026
	75	5	61128060	3,245
M10	30	5	61128065	2,026
	75	5	61128070	3,245
M12	30	5	61128075	2,429
	75	5	61128080	3,921
M13	30	5	61128085	2,429
	75	5	61128090	3,921
M14	30	5	61128095	2,842
	75	5	61128100	4,325
M16	30	5	61128105	3,245
	75	5	61128110	6,482

61127

RIBE H - 10mm (3/8")

INSERTI 10mm (3/8") PER VITI RIBE® CON FORO PER MECCANICA

10mm (3/8") BITS FOR RIBE® MECHANICAL SCREWS WITH HOLE

56/58 HRC

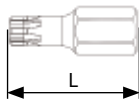

EASYPACK | sacchetto PVC con Euro-hole - PVC bags with Euro-hole

	L mm	PCS.	COD.	€ cad./each
MH5	30	5	61127005	2,570
	75	5	61127010	3,921
MH6	30	5	61127015	2,570
	75	5	61127020	3,921
MH7	30	5	61127025	2,570
	75	5	61127030	3,921
MH8	30	5	61127035	2,570
	75	5	61127040	3,921
MH9	30	5	61127045	2,570
	75	5	61127050	3,921
MH10	30	5	61127055	2,570
	75	5	61127060	3,921
MH12	30	5	61127065	2,974
	75	5	61127070	4,596



62081

PORTAINSERTI 3/8" CON SFERA

PORTAINSERTI CON SFERA 3/8" PER INSERTE 10mm

3/8" BIT-HOLDER WITH BALL FOR 10mm BITS

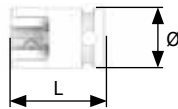

EASYPACK | sacchetto PVC con Euro-hole - PVC bags with Euro-hole

L mm	Ø mm	PCS.	COD.	€ cad./each
30	17	1	62081005	4,575

62082

PORTAINSERTI 3/8" SNODATO

PORTAINSERTI SNODATO CON BLOCCO 3/8" PER INSERTE 10mm

ARTICULATED 3/8" BIT HOLDER WITH LOCK FOR 10mm BITS



EASYPACK | sacchetto PVC con Euro-hole - PVC bags with Euro-hole

L mm	Ø mm	PCS.	COD.	€ cad./each
90	25	1	62082005	33,163

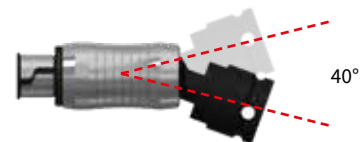

62083

PORTAINSERTI 1/2" CON SFERA

PORTAINSERTI CON SFERA 1/2" PER INSERTE 10mm

1/2" BIT-HOLDER WITH BALL FOR 10mm BITS

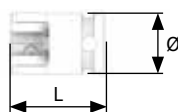

EASYPACK | sacchetto PVC con Euro-hole - PVC bags with Euro-hole

L mm	Ø mm	PCS.	COD.	€ cad./each
36	22	1	62083005	5,986



2 INSERTI E CHIAVI SPECIALI BITS AND SPECIAL SETTERS

66013

ASSORTIMENTI INSERTI 10mm (3/8") TX/TXH

ASSORTIMENTO 22 PCS. INSERTI 10mm (3/8")
SET OF 22 BITS 10mm (3/8")



22
pcs.

282 X 35 X 130 mm

COD. **66013005**

€ 54,199

61100x30mm

TX10	TX15	TX20	TX25	TX27	TX30	TX40	TX45	TX50	TX55
1pc.	1pc.	1pc.	1pc.	1pc.	1pc.	1pc.	1pc.	1pc.	1pc.

61100x75mm

TX10	TX15	TX20	TX25	TX27	TX30	TX40	TX45	TX50	TX55
1pc.	1pc.	1pc.	1pc.	1pc.	1pc.	1pc.	1pc.	1pc.	1pc.

COD. **66013010**

€ 64,788

61114x30mm

TXH10	TXH15	TXH20	TXH25	TXH27	TXH30	TXH40	TXH45	TXH50	TXH55
1pc.	1pc.	1pc.	1pc.	1pc.	1pc.	1pc.	1pc.	1pc.	1pc.

61114x75mm

TXH10	TXH15	TXH20	TXH25	TXH27	TXH30	TXH40	TXH45	TXH50	TXH55
1pc.	1pc.	1pc.	1pc.	1pc.	1pc.	1pc.	1pc.	1pc.	1pc.

INCLUSO
INCLUDED

COD. 62081005



COD. 62083005



66013

ASSORTIMENTI INSERTI 10mm (3/8") RIBE

ASSORTIMENTO 20 PCS. INSERTI 10mm (3/8")
SET OF 20 BITS 10mm (3/8")



20
pcs.

282 X 35 X 130 mm

COD. **66013015**

€ 62,854

61128x30mm

M6	M7	M8	M9	M10	M12	M13	M14	M16
1pc.	1pc.	1pc.	1pc.	1pc.	1pc.	1pc.	1pc.	1pc.

61128x75mm

M6	M7	M8	M9	M10	M12	M13	M14	M16
1pc.	1pc.	1pc.	1pc.	1pc.	1pc.	1pc.	1pc.	1pc.

INCLUSO
INCLUDED

COD. 62081005



COD. 62083005





66013

ASSORTIMENTI INSERTI 10mm (3/8")

ASSORTIMENTO 40 PCS. INSERTI 10mm (3/8")

SET OF 40 BITS 10mm (3/8")



40
pcs.

320 X 35 X 150 mm

INCLUSO
INCLUDED

COD. 62081005



COD. 62083005



COD. **66013016**

€ 102,900

61100x30mm

TX20	TX25	TX30	TX40	TX45	TX50	TX55
1pc.	1pc.	1pc.	1pc.	1pc.	1pc.	1pc.

61128x30mm

M5	M6	M7	M8	M9	M10	M12
1pc.	1pc.	1pc.	1pc.	1pc.	1pc.	1pc.

61129x30mm

M5	M6	M8	M10	M12
1pc.	1pc.	1pc.	1pc.	1pc.

61100x75mm

TX20	TX25	TX30	TX40	TX45	TX50	TX55
1pc.	1pc.	1pc.	1pc.	1pc.	1pc.	1pc.

61128x75mm

M5	M6	M7	M8	M9	M10	M12
1pc.	1pc.	1pc.	1pc.	1pc.	1pc.	1pc.

61129x75mm

M5	M6	M8	M10	M12
1pc.	1pc.	1pc.	1pc.	1pc.

2



2 INSERTI E CHIAVI SPECIALI

BITS AND SPECIAL SETTERS

61053

PH - 5/16" C

INSERTI 5/16" C (C8) PHILLIPS® PER MECCANICA E CARPENTERIA

PHILLIPS® 5/16" C (C8) BITS FOR MECHANICAL AND STRUCTURAL WORKS

56/58 HRC

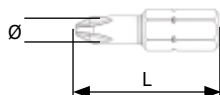

EASYPACK | sacchetto PVC con Euro-hole - PVC bags with Euro-hole

+	L mm	Ø mm	PCS.	COD.	€ cad./each
PH1	32	4,5	5	61053005	2,341
PH2	32	6	5	61053010	2,341
PH3	32	5/16	5	61053015	2,341
PH4	38	10	5	61053020	2,341

61077

PZ - 5/16" C

INSERTI 5/16" C (C8) POZIDRIV® PER MECCANICA E CARPENTERIA

POZIDRIV® 5/16" C (C8) BITS FOR MECHANICAL AND STRUCTURAL WORKS

56/58 HRC



EASYPACK | sacchetto PVC con Euro-hole - PVC bags with Euro-hole

+	L mm	Ø mm	PCS.	COD.	€ cad./each
PZ1	32	4,5	5	61077005	2,341
PZ2	32	6	5	61077010	2,341
PZ3	32	5/16	5	61077015	2,341
PZ4	38	10	5	61077020	2,341

**61024****TAGLIO - 5/16" C****INSERTI 5/16" C (C8) A TAGLIO PER MECCANICA E CARPENTERIA**

5/16" C (C8) SLOTTED BITS FOR MECHANICAL AND STRUCTURAL WORKS

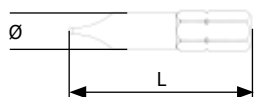
56/58 HRC

EASYPACK | sacchetto PVC con Euro-hole - PVC bags with Euro-hole

	Ø mm	L mm	PCS.	COD.	€ cad./each
1	6,5	41	5	61024005	2,571
1,2	7	41	5	61024010	2,571
1,2	8	41	5	61024015	2,571
1,6	10	41	5	61024020	3,198
2	13	41	5	61024025	4,318

61008**ESAGONO - 5/16" C****INSERTI 5/16" C (C8) ESAGONALI PER MECCANICA E CARPENTERIA**

5/16" C (C8) HEX BITS FOR MECHANICAL AND STRUCTURAL WORKS

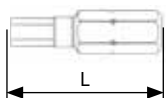
56/58 HRC

EASYPACK | sacchetto PVC con Euro-hole - PVC bags with Euro-hole

	L mm	PCS.	COD.	€ cad./each
3	30	5	61008005	2,616
4	30	5	61008010	2,616
5	30	5	61008015	2,616
6	30	5	61008020	2,616
8	30	5	61008025	2,616
10	30	5	61008030	2,616



2 INSERTI E CHIAVI SPECIALI

BITS AND SPECIAL SETTERS

61099

TX - 5/16\"C

INSERTI 5/16\"C (C8) PER VITI TORX® PER MECCANICA E CARPENTERIA
5/16\"C (C8) BITS FOR TORX® SCREWS FOR MECHANICAL AND STRUCTURAL WORKS

56/58 HRC

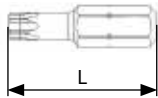

EASYPACK | sacchetto PVC con Euro-hole - PVC bags with Euro-hole

	L mm	PCS.	COD.	€ cad./each
TX20	35	5	61099005	2,500
TX25	35	5	61099010	2,500
TX27	35	5	61099015	2,500
TX30	35	5	61099020	2,500
TX40	35	5	61099025	2,500
TX45	35	5	61099030	2,500
TX50	35	5	61099035	2,500
TX55	35	5	61099040	2,500

65006

GIRAVITE A PERCUSSIONE

SET 8 PCS GIRAVITE A PERCUSSIONE CON INSERTI 5/16\"C ED ESTRATTORI
8 PCS IMPACT SCREWDRIVER WITH 5/16\"C BITS AND EXTRACTORS

35 Nm



**8
pcs.**

COD. **65006200**

€ 61,400

PH2	PH3	8	10
1pc.	1pc.	1pc.	1pc.



INCLUSO
INCLUDED

COD. 62064010

M8-M11 / M11-M14



**62063**

PORTAINSERTI 3/8" CON SFERA

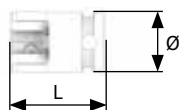
PORTAINSERTI CON SFERA 3/8" PER INSERTE 5/16"C**3/8" BIT-HOLDER WITH BALL FOR 5/16"C BITS****EASYPACK** | sacchetto PVC con Euro-hole • PVC bags with Euro-hole

L mm	Ø mm	PCS.	COD.	€ cad./each
28	17	1	62063010	4,575

62063

PORTAINSERTI 3/8" CON ANELLO C

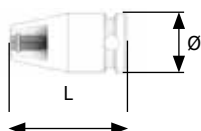
PORTAINSERTI CON ANELLO C 3/8" PER INSERTE 5/16"C**3/8" BIT-HOLDER WITH C RING FOR 5/16"C BITS****EASYPACK** | sacchetto PVC con Euro-hole • PVC bags with Euro-hole

L mm	Ø mm	PCS.	COD.	€ cad./each
35	19	1	62063005	12,701



2 INSERTI E CHIAVI SPECIALI

BITS AND SPECIAL SETTERS

62064

PORTAINSERTI 1/2" CON SFERA

PORTAINSERTI CON SFERA 1/2" PER INSERTI 5/16"C
 1/2" BIT-HOLDER WITH BALL FOR 5/16"C BITS

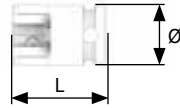

EASYPACK | sacchetto PVC con Euro-hole - PVC bags with Euro-hole

L mm	Ø mm	PCS.	COD.	€ cad./each
38	22	1	62064010	5,986

62064

PORTAINSERTI 1/2" CON ANELLO C

PORTAINSERTI CON ANELLO 1/2" PER INSERTI 5/16"C
 1/2" BIT-HOLDER WITH C RING FOR 5/16"C BITS

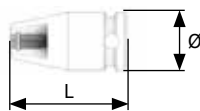

EASYPACK | sacchetto PVC con Euro-hole - PVC bags with Euro-hole

L mm	Ø mm	PCS.	COD.	€ cad./each
35	24	1	62064005	14,818

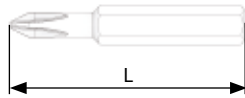
**61140****PH - 4mm (5/32"-C4)****INSERTI 4mm (5/32" C) PER MICRO-VITI PHILLIPS®**
4mm (5/32" C) BITS FOR PHILLIPS® MICRO-SCREWS**58/60 HRC****EASYPACK** | sacchetto PVC con Euro-hole - PVC bags with Euro-hole

	L mm	PCS.	COD.	€ cad./each
PH000	28	10	61140001	1,120
PH00	28	10	61140002	1,120
PH0	28	10	61140005	1,120
PH1	28	10	61140010	1,120
PH2	28	10	61140020	1,120

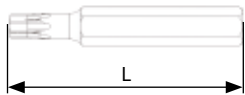
61142**TX - 4mm (5/32"-C4)****INSERTI 4mm (5/32" C) PER MICRO-VITI TORX®**
4mm (5/32" C) BITS FOR TORX® MICRO-SCREWS**58/60 HRC****EASYPACK** | sacchetto PVC con Euro-hole - PVC bags with Euro-hole

	L mm	PCS.	COD.	€ cad./each
TX03	28	10	61142005	1,176
TX04	28	10	61142010	1,176
TX05	28	10	61142015	1,176
TX06	28	10	61142020	1,176
TX07	28	10	61142025	1,176
TX08	28	10	61142030	1,176

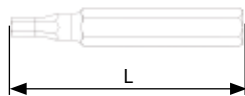
61143**ESAGONO 4mm (5/32"-C4)****INSERTI 4mm (5/32" C) PER MICRO-VITI ESAGONALI**
4mm (5/32" C) BITS FOR HEXAGON MICRO-SCREWS**58/60 HRC****EASYPACK** | sacchetto PVC con Euro-hole - PVC bags with Euro-hole

	L mm	PCS.	COD.	€ cad./each
0,7	28	10	61143005	1,266
0,9	28	10	61143010	1,266
1,3	28	10	61143015	1,266



2 INSERTI E CHIAVI SPECIALI BITS AND SPECIAL SETTERS

61144

TAGLIO 4mm (5/32"-C4)

INSERTI 4mm (5/32" C) PER MICRO-VITI A TAGLIO
4mm (5/32" C) BITS FOR SLOTTED MICRO-SCREWS

58/60 HRC

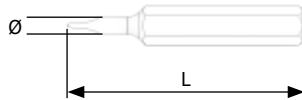

EASYPACK | sacchetto PVC con Euro-hole - PVC bags with Euro-hole

Ø mm	L mm	PCS.	COD.	€ cad./each
0,3	1,5	28	61144005	1,210
0,37	1,8	28	61144010	1,210
0,4	2	28	61144015	1,210
0,4	2,5	28	61144020	1,210

61146

PENTALOBE 4mm (5/32"-C4)

INSERTI 4mm (5/32" C) PER MICRO-VITI PENTALOBATE
4mm (5/32" C) BITS FOR 5-LOBED MICRO-SCREWS

58/60 HRC

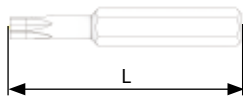

EASYPACK | sacchetto PVC con Euro-hole - PVC bags with Euro-hole

L mm	PCS.	COD.	€ cad./each
P1 28	10	61146005	1,680
P4 28	10	61146020	1,680



FOCUS ON



I dispositivi elettronici sono ormai nelle mani di tutti e, con loro, le micro viti sono largamente diffuse. Prerogativa di questo tipo di fasteners è l'estrema precisione.

Suitable for the production of electronic devices where micro-screws are widely used. The special feature of this type of fastener is its extreme precision.



66015

ASSORTIMENTI INSERTI DI PRECISIONE

ASSORTIMENTO 22 PCS. INSERTI PER MICRO-VITI CON IMPUGNATURA E PROLUNGA
SET OF 22 BITS FOR MICRO-SCREWS WITH HANDLE AND EXTENSION



22
pcs.

COD. **66015001**
€ 38,976

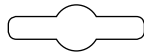

EURO-HOLE

135 X 35 X 70 mm

INCLUSO
INCLUDED

COD. 62001015



COD. 62001100



61140



PH000 1pc.	PH00 1pc.	PH0 1pc.	PH1 1pc.	PH2 1pc.
---------------	--------------	-------------	-------------	-------------

61142



TX03 1pc.	TX04 1pc.	TX05 1pc.	TX06 1pc.	TX07 1pc.	TX08 1pc.
--------------	--------------	--------------	--------------	--------------	--------------

61144



0,3x1,5 1pc.	0,37x 1,8 1pc.	0,4x2,0 1pc.	0,4x2,5 1pc.
-----------------	-------------------	-----------------	-----------------

61143



0,7 1pc.	0,9 1pc.	1,3 1pc.
-------------	-------------	-------------

61146



P1 1pc.	P4 1pc.
------------	------------



FOCUS ON



Per completare l'assortimento delle impronte per micro-viti più usate, abbiamo aggiunto un'impugnatura in alluminio con mandrino rapido di elevata qualità e praticità ed una prolunga magnetica.

To complete the range of tips for the most common micro-screws, we have added a practical aluminium handle with a chuck of the highest quality and a magnetic extension.



2 INSERTI E CHIAVI SPECIALI

BITS AND SPECIAL SETTERS

66015

ASSORTIMENTI INSERTI DI PRECISIONE

ASSORTIMENTO 17 PCS INSERTI PER MICRO VITI CON ACCESSORI
 17 PCS SET BITS FOR MICRO-SCREWS AND ACCESSORIES



17 pcs.

COD. **66015010**

€ 16,688

PH000 1pc.	PH00 1pc.	PH0 1pc.	TX02 1pc.	TX03 1pc.	TX05 1pc.	TX06 1pc.	
1,0x0,3 1pc.		2,0x0,4 1pc.		2,6 1pc.		P2 1pc.	
						P5 1pc.	

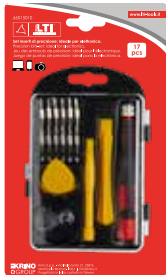

220 X 30 X 130 mm





66015

ASSORTIMENTI INSERTI DI PRECISIONE

ASSORTIMENTO 50 PCS INSERTI PER MICRO VITI CON ACCESSORI
50 PCS SET BITS FOR MICRO-SCREWS AND ACCESSORIES



50 pcs.

COD. **66015011**
 € 44,352

PH000 1pc.	PH00 1pc.	PH0 1pc.	PH1 1pc.	TX03 1pc.	TX04 1pc.	TX05 1pc.
TXH06 1pc.	TXH07 1pc.	TXH08 1pc.	TXH09 1pc.	TXH10 1pc.	TXH15 1pc.	
1,0x0,3 1pc.	1,5x0,3 1pc.	2,0x0,4 1pc.	2,5x0,4 1pc.	3,x4, 1pc.		
0 1pc.	1 1pc.	P2 1pc.	P5 1pc.	P6 1pc.		
0,9 1pc.	1,3 1pc.	1,5 1pc.	2 1pc.	2,5 1pc.	3 1pc.	
0,8 1pc.	0 1pc.	1 1pc.	1,6 1pc.	2 1pc.	2,2 1pc.	2,3 1pc.
2,5 1pc.	3 1pc.	3,5 1pc.	4 1pc.	4,5 1pc.	5 1pc.	



EURO-HOLE

240 X 45 X 110 mm





2 INSERTI E CHIAVI SPECIALI BITS AND SPECIAL SETTERS

62001

PORTAINSERTI 3mm MAGNETICI

PORTAINSERTI MAGNETICO 3mm PER INSERTI 4mm (5/32" C)

3mm MAGNETIC BIT-HOLDER FOR 4mm (5/32" C) BITS

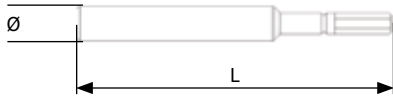

EASYPACK | sacchetto PVC con Euro-hole - PVC bags with Euro-hole

L mm	Ø mm	PCS.	COD.	€ cad./each
55	6,5	5	62001005	44,100

62001

PORTAINSERTI 1/4"E MAGNETICI

PORTAINSERTI MAGNETICO 1/4"E PER INSERTI 4mm (5/32" C)

1/4"E MAGNETIC BIT-HOLDER FOR BITS 4mm (5/32" C)

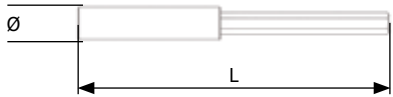

EASYPACK | sacchetto PVC con Euro-hole - PVC bags with Euro-hole

L mm	Ø mm	PCS.	COD.	€ cad./each
75	8,5	1	62001010	13,877

**62001**

PROLUNGHE 4mm (5/32" C)

PROLUNGA CON ANELLO C 4mm (5/32" C) PER INSERTI 4mm (5/32" C) CON ANELLO C
4mm (5/32" C) EXTENSION FOR 4mm (5/32" C) BITS WITH C RING

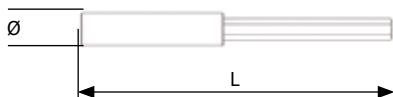

EASYPACK | sacchetto PVC con Euro-hole - PVC bags with Euro-hole

L mm	Ø mm	PCS.	COD.	€ cad./each
70	7,5	1	62001015	6,938

62001

IMPUGNATURE DI PRECISIONE IN ALLUMINIO

IMPUGNATURA CON BLOCCO PER INSERTI 4mm (5/32" C)
HANDLE WITH LOCK FOR 4mm (5/32" C) BITS

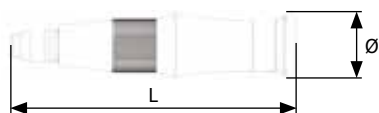

EASYPACK | sacchetto PVC con Euro-hole - PVC bags with Euro-hole

L mm	Ø mm	PCS.	COD.	€ cad./each
90	20	1	62001100	25,519

2



2 INSERTI E CHIAVI SPECIALI

BITS AND SPECIAL SETTERS

61035

PH - M4

INSERTI M4 PHILLIPS® PER AVVITATORI AUTOALIMENTATI

PHILLIPS® M4 BITS FOR FIXTURED SCREWDRIVERS

59/61 HRC

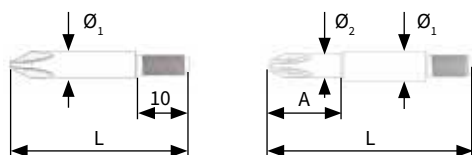

EASYPACK | sacchetto PVC con Euro-hole - PVC bags with Euro-hole

	L mm	Ø ₁ mm	Ø ₂ mmxA	PCS.	COD.	€ cad./each
	33	5		10	61035005	6,003
PH1	34	5		10	61035010	6,003
	45	6	5x15	10	61035015	6,306
PH2	34	6		10	61035020	6,003
	45	6		10	61035025	6,306

61061

PZ - M4

INSERTI M4 POZIDRIV® PER AVVITATORI AUTOALIMENTATI

POZIDRIV® M4 BITS FOR FIXTURED SCREWDRIVERS

59/61 HRC

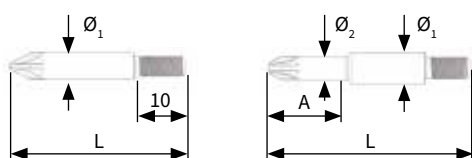

EASYPACK | sacchetto PVC con Euro-hole - PVC bags with Euro-hole

	L mm	Ø ₁ mm	Ø ₂ mmxA	PCS.	COD.	€ cad./each
	33	5		10	61061005	6,003
PZ1	34	5		10	61061010	6,003
	45	6	5x15	10	61061015	6,306
PZ2	34	6		10	61061020	6,003
	45	6		10	61061025	6,306

61091

TX - M4

INSERTI M4 PER VITI TORX® PER AVVITATORI AUTOALIMENTATI

M4 BITS FOR TORX® SCREWS FOR FIXTURED SCREWDRIVERS

59/61 HRC

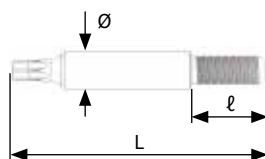

EASYPACK | sacchetto PVC con Euro-hole - PVC bags with Euro-hole

	L mm	ℓ mm	Ø mm	PCS.	COD.	€ cad./each
TX08	33	10	5	10	61091004	7,504
TX09	33	10	5	10	61091005	7,504
TX10	33	10	5	10	61091010	7,504
TX15	33	10	6	10	61091015	7,504
TX20	33	10	6	10	61091020	7,504
TX25	33	10	6	10	61091025	7,504

**62005**

PORTAINSERTI 1/4"E PER INSERTI M4

PORTAINSERTI 1/4"E PER INSERTI M4

1/4"E BIT-HOLDER FOR M4 BITS

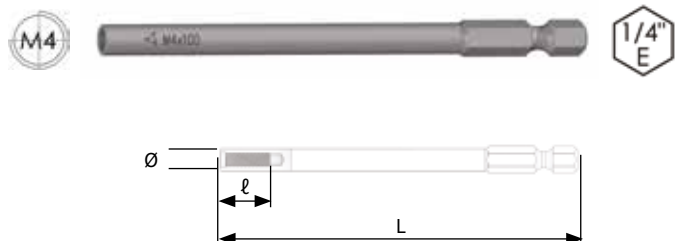

EASYPACK | sacchetto PVC con Euro-hole - PVC bags with Euro-hole

L mm	ℓ mm	Ø mm	PCS.	COD.	€ cad./each
75	15	6	5	62005005	27,104
100	15	6	5	62005010	30,800
175	15	6	5	62005015	36,064



FOCUS ON



Connessione di tipo rinforzato, ottimizza la resistenza del filetto evitando la necessità di ridurre la durezza.

Il sistema inserto + portainseriti risulta estremamente indicato nelle applicazioni industriali con avvitatori automatici/autoalimentati e su impianti di avvitatura complessi. In questi casi sono estremamente importanti l'affidabilità del prodotto e la sua capacità di resistere all'usura. Per questi motivi i nostri inserti vengono realizzati con tolleranze minime su macchine estremamente precise con l'obiettivo di garantire la massima qualità. La connessione di tipo rinforzato permette inoltre di mantenere elevata la durezza dell'inserto.

Reinforced connection optimises the resistance of the thread, preventing the need to reduce the hardness.

The bit + bit-holder system is very suitable in industrial applications that use automatic/fixtured screwdrivers and complex screwing systems. In these cases, product reliability and wear resistance are extremely important. For these reasons, our bits are manufactured with minimum tolerances on high-precision machines aimed at ensuring maximum quality. The reinforced connection also allows maintaining excellent hardness of the bit.



2 INSERTI E CHIAVI SPECIALI

BITS AND SPECIAL SETTERS

61036

PH - M5

INSERTI M5 PHILLIPS® PER AVVITATORI AUTOALIMENTATI

PHILLIPS® M5 BITS FOR FIXTURED SCREWDRIVERS

59/61 HRC

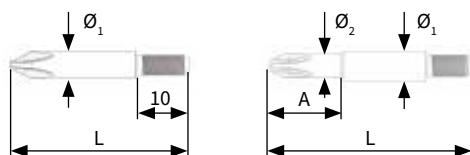

EASYPACK | sacchetto PVC con Euro-hole - PVC bags with Euro-hole

	L mm	Ø ₁ mm	Ø ₂ mmxA	PCS.	COD.	€ cad./each
PH1	34	6,5		10	61036005	5,342
	45	6	5x15	10	61036010	5,701
	31	7		10	61036013	5,342
PH2	33	6		10	61036014	5,342
	33	7		10	61036015	5,342
	34	6,5		10	61036020	5,342
	45	6		10	61036023	5,701
	45	6,5		10	61036025	5,701

61062

PZ - M5

INSERTI M5 POZIDRIV® PER AVVITATORI AUTOALIMENTATI

POZIDRIV® M5 BITS FOR FIXTURED SCREWDRIVERS

59/61 HRC

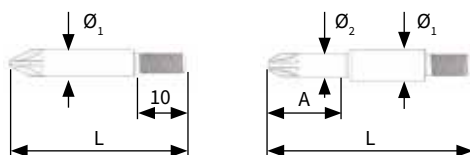

EASYPACK | sacchetto PVC con Euro-hole - PVC bags with Euro-hole

	L mm	Ø ₁ mm	Ø ₂ mmxA	PCS.	COD.	€ cad./each
PZ1	34	6,5		10	61062005	5,342
	45	6	5x15	10	61062010	5,701
	31	7		10	61062013	5,342
	33	6		10	61062014	5,342
PZ2	33	7		10	61062015	5,342
	34	6,5		10	61062020	5,342
	45	6		10	61062023	5,701
	45	6,5		10	61062025	5,701

61110

TXH - M5

INSERTI M5 PER VITI TORX® ANTI-MANOMISSIONE PER AVVITATORI AUTOALIMENTATI

M5 BITS FOR TORX® TAMPER-RESISTANT SCREWS FOR FIXTURED SCREWDRIVERS

59/61 HRC

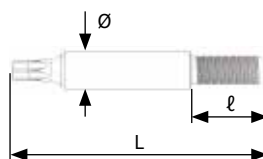

EASYPACK | sacchetto PVC con Euro-hole - PVC bags with Euro-hole

	L mm	ℓ mm	Ø mm	PCS.	COD.	€ cad./each
TXH15	33	10	7	10	61110005	9,307
TXH20	33	10	7	10	61110010	9,307
TXH25	33	10	7	10	61110015	9,307



61092

TX - M5

INSERTI M5 PER VITI TORX® PER AVVITATORI AUTOALIMENTATI

M5 BITS FOR TORX® SCREWS FOR FIXTURED SCREWDRIVERS

59/61 HRC

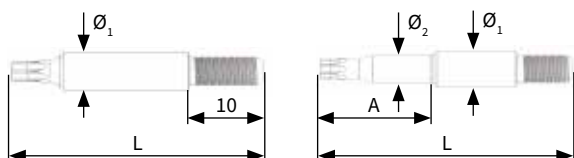

EASYPACK | sacchetto PVC con Euro-hole - PVC bags with Euro-hole

	L mm	Ø ₁ mm	Ø ₂ mmxA	PCS.	COD.	€ cad./each
TX10	33	6,5		10	61092002	7,202
	45	6		10	61092004	7,650
	45	6,5	5x20	10	61092005	7,650
TX15	33	6,5		10	61092010	7,202
	45	6		10	61092014	7,650
	45	6,5	5x20	10	61092015	7,650
TX20	33	6,5		10	61092020	7,202
	45	6		10	61092024	7,650
	45	6,5		10	61092025	7,650
TX25	33	6,5		10	61092030	7,202
	45	6		10	61092034	7,650
	45	7		10	61092035	7,650
TX30	33	7		10	61092037	7,202
	45	7		10	61092040	7,650
TX40	45	7		10	61092045	7,650

62006

PORTAINSERI 1/4"E PER INSERTI M5

PORTAINSERI 1/4"E PER INSERTI M5

1/4"E BIT-HOLDER FOR M5 BITS

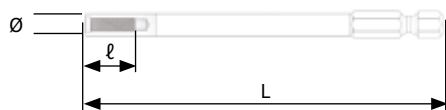

EASYPACK | sacchetto PVC con Euro-hole - PVC bags with Euro-hole

L mm	ℓ mm	Ø mm	PCS.	COD.	€ cad./each
85	15	7	5	62006035	27,664
125	15	7	5	62006010	28,000
130	15	7	5	62006005	28,224
135	15	7	5	62006040	29,120
150	15	7	5	62006015	30,016
165	15	7	5	62006045	30,800
175	15	7	5	62006020	31,584
200	15	7	5	62006025	36,064



2 INSERTI E CHIAVI SPECIALI

BITS AND SPECIAL SETTERS

61037

PH - M6

INSERTI M6 PHILLIPS® PER AVVITATORI AUTOALIMENTATI

PHILLIPS® M6 BITS FOR FIXTURED SCREWDRIVERS

59/61 HRC

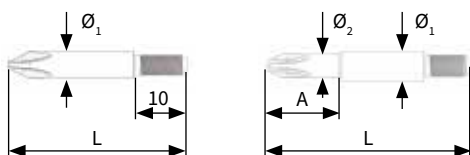

EASYPACK | sacchetto PVC con Euro-hole - PVC bags with Euro-hole

	L mm	Ø ₁ mm	Ø ₂ mmxA	PCS.	COD.	€ cad./each
PH2	33	8		10	61037002	7,358
	45	8		10	61037010	7,650
PH3	44	7	5x10	10	61037005	7,650
	34	8	7,5x18	10	61037015	7,358
	45	8		10	61037020	7,650

61063

PZ - M6

INSERTI M6 POZIDRIV® PER AVVITATORI AUTOALIMENTATI

POZIDRIV® M6 BITS FOR FIXTURED SCREWDRIVERS

59/61 HRC

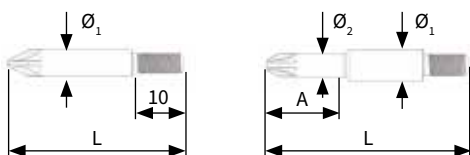

EASYPACK | sacchetto PVC con Euro-hole - PVC bags with Euro-hole

	L mm	Ø ₁ mm	Ø ₂ mmxA	PCS.	COD.	€ cad./each
PZ2	33	8		10	61063002	7,358
	45	8		10	61063005	7,650
PZ3	34	8,5	7,5x18	10	61063010	7,358
	45	8		10	61063015	7,650

61093

TX - M6

INSERTI M6 PER VITI TORX® PER AVVITATORI AUTOALIMENTATI

M6 BITS FOR TORX® SCREWS FOR FIXTURED SCREWDRIVERS

59/61 HRC

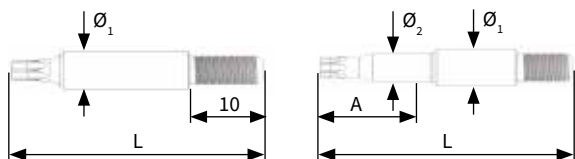

EASYPACK | sacchetto PVC con Euro-hole - PVC bags with Euro-hole

	L mm	Ø ₁ mm	Ø ₂ mmxA	PCS.	COD.	€ cad./each
TX15	45	8		10	61093002	8,098
	33	8	4x16	10	61093003	7,806
TX20	45	8	5x25	10	61093005	8,098
	33	8		10	61093010	7,806
TX25	45	8		10	61093012	8,098
	33	8		10	61093014	7,806
TX30	45	8		10	61093015	8,098
	45	8		10	61093020	8,098

**62007**

PORTAINSERTI 1/4"E PER INSERTI M6

PORTAINSERTI 1/4"E PER INSERTI M6

1/4"E BIT-HOLDER FOR M6 BITS

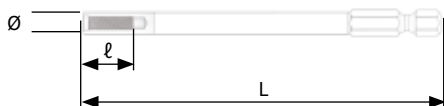

EASYPACK | sacchetto PVC con Euro-hole - PVC bags with Euro-hole

L mm	ℓ mm	Ø mm	PCS.	COD.	€ cad./each
100	15	10	5	62007005	30,912
165	15	8	5	62007010	36,064
200	15	8	5	62007015	36,064



FOCUS ON

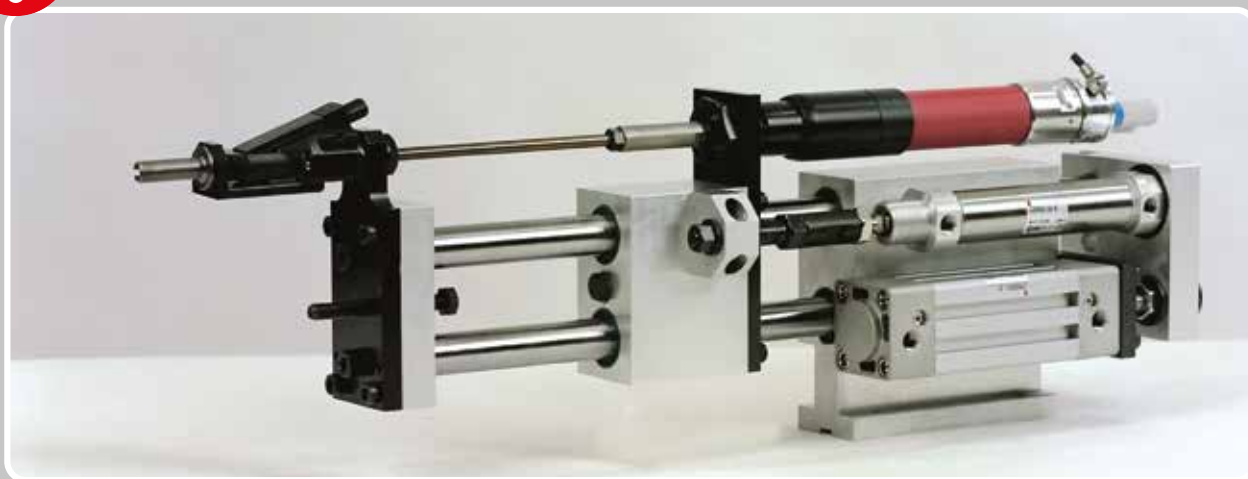

Esempio di avvitatore autoalimentato con applicazione di portainseri ed inserto filettati (per gentile concessione di MTA TECH S.r.l.)
Example of self-powered screwdriver with application of bit holder and threaded insert (by kind permission of MTA TECH S.r.l.)

I nostri portainseri filettati sono realizzati con lo stesso acciaio di alta qualità che utilizziamo per gli inserti. Il trattamento termico è calibrato per ottenere anche in questo caso il miglior equilibrio tra durezza e tenacità. Come ultima fase di lavorazione, prima dello stoccaggio, viene controllata la rettilinearità di questi prodotti e viene eventualmente eseguita un'operazione di raddrizzatura al fine di garantire una concentricità non inferiore a 0,1mm.

Our threaded bit holders are made with the same high-quality steel used for the bits. The heat treatment is calibrated to obtain the best balance between hardness and toughness. As a final machining phase before storage, the straightness of these products is checked and if necessary, they are straightened to ensure concentricity of not less than 0.1 mm.



2 INSERTI E CHIAVI SPECIALI

BITS AND SPECIAL SETTERS

61039

PH - UNF 10X32

INSERTI UNF 10X32 PHILLIPS® PER AVVITATORI AUTOALIMENTATI

PHILLIPS® UNF 10x32 BITS FOR FIXTURED SCREWDRIVERS

59/61 HRC

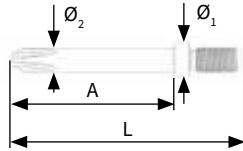

EASYPACK | sacchetto PVC con Euro-hole - PVC bags with Euro-hole

	L mm	Ø ₁ mm	Ø ₂ mmxA	PCS.	COD.	€ cad./each
PH1	45	6,5	4,5x32	10	61039005	7,806
PH2	45	6,5	4,5x32	10	61039010	7,806

61065

PZ - UNF 10X32

INSERTI UNF 10X32 POZIDRIV® PER AVVITATORI AUTOALIMENTATI

POZIDRIV® UNF 10x32 BITS FOR FIXTURED SCREWDRIVERS

59/61 HRC

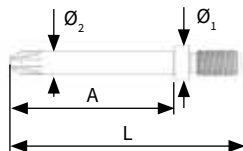

EASYPACK | sacchetto PVC con Euro-hole - PVC bags with Euro-hole

	L mm	Ø ₁ mm	Ø ₂ mmxA	PCS.	COD.	€ cad./each
PZ1	45	6,5	4,5x32	10	61065005	7,806
PZ2	45	6,5	4,5x32	10	61065010	7,806

61090

TX - UNF 10X32

INSERTI UNF 10X32 PER VITI TORX® PER AVVITATORI AUTOALIMENTATI

UNF 10x32 BITS FOR TORX® SCREWS FOR FIXTURED SCREWDRIVERS

59/61 HRC

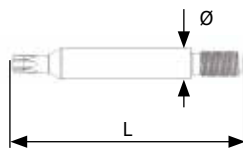

EASYPACK | sacchetto PVC con Euro-hole - PVC bags with Euro-hole

	L mm	Ø mm	PCS.	COD.	€ cad./each
TX10	45	6	10	61090005	8,098
TX15	45	6	10	61090010	8,098
TX20	45	6	10	61090015	8,098
TX25	45	6	10	61090020	8,098
TX30	45	6	10	61090025	8,098



62009

PORTAINSERTI 1/4"E PER INSERTI UNF 10X32

PORTAINSERTI 1/4"E PER INSERTI UNF 10X32

1/4"E BIT-HOLDER FOR UNF 10x32 BITS

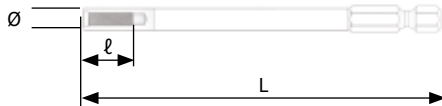

EASYPACK | sacchetto PVC con Euro-hole - PVC bags with Euro-hole

L mm	ℓ mm	Ø mm	PCS.	COD.	€ cad./each
100	15	7	5	62009005	28,000
117	15	7	5	62009010	29,120
175	15	7	5	62009015	39,760



FOCUS ON



Versione specifica per macchine assemblaggio serramenti
(a richiesta).

Specific version for assembly machines.

2



Esempio di avvitatore autoalimentato con applicazione di portainseri ed inserto filettati (per gentile concessione di MTA TECH S.r.l.).

Example of self-powered screwdriver with application of bit holder and threaded insert (by kind permission of MTA TECH S.r.l.).



2 INSERTI E CHIAVI SPECIALI BITS AND SPECIAL SETTERS

61038 PH - BSF 3/16X32

INSERTI BSF 3/16X32 (WITHWORTH) PHILLIPS® PER AVVITATORI AUTOALIMENTATI
PHILLIPS® BSF 3/16x32 BITS (WITHWORTH) FOR FIXTURED SCREWDRIVERS

59/61 HRC

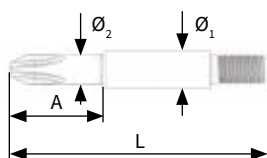

EASYPACK | sacchetto PVC con Euro-hole - PVC bags with Euro-hole

	L mm	Ø ₁ mm	Ø ₂ mmxA	PCS.	COD.	€ cad./each
PH1	45	6	5x15	10	61038005	9,598
PH2	45	6		10	61038010	9,598

61064 PZ - BSF 3/16X32

INSERTI BSF 3/16X32 (WITHWORTH) POOZIDRIV PER AVVITATORI AUTOALIMENTATI
POZIDRIV® BSF 3/16x32 BITS (WITHWORTH) FOR FIXTURED SCREWDRIVERS

59/61 HRC

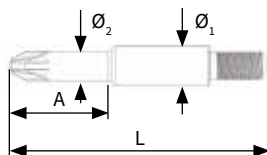

EASYPACK | sacchetto PVC con Euro-hole - PVC bags with Euro-hole

	L mm	Ø ₁ mm	Ø ₂ mmxA	PCS.	COD.	€ cad./each
PZ1	45	6	5x15	10	61064005	9,598
PZ2	45	6		10	61064010	9,598

62008 PORTAINSERI 1/4"E PER INSERTI BSF 3/16X32

PORTAINSERI 1/4"E PER INSERTI BSF 3/16X32
1/4" E BIT-HOLDER FOR BSF 3/16x32 BITS



EASYPACK | sacchetto PVC con Euro-hole - PVC bags with Euro-hole

L mm	l mm	Ø mm	PCS.	COD.	€ cad./each
84	15	7	5	62008005	33,040



61012

ESAGONO 7/16" RAPIDO

LAME 7/16" RAPIDO ESAGONALI PER AVVITATORI
QUICK 7/16" HEXAGONAL POWER BITS FOR DRIVERS

56/58 HRC

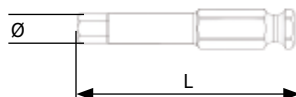

EASYPACK | sacchetto PVC con Euro-hole - PVC bags with Euro-hole

	L mm	PCS.	COD.	€ cad./each
3	70	5	61012005	21,392
4	70	5	61012010	21,392
5	70	5	61012015	21,392
6	70	5	61012025	21,392
8	70	5	61012035	21,392
10	70	5	61012045	21,392

2

62085

PORTAINSERTI 1/2" X 7/16" IMPACT MANDRINO RAPIDO

PORTAINSERTI IMPACT 1/2" PER 7/16" CON MANDRINO DI BLOCCO
1/2" FOR 7/16" IMPACT BIT-HOLDER WITH CHUCK

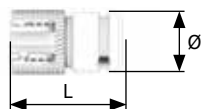

EASYPACK | sacchetto PVC con Euro-hole - PVC bags with Euro-hole

L mm	Ø mm	PCS.	COD.	€ cad./each
45	25	1	62085005	154,409



2 INSERTI E CHIAVI SPECIALI

BITS AND SPECIAL SETTERS

61055

PH - 5/16" RAPIDO

LAME 5/16" RAPIDO PHILLIPS® PER AVVITATORI
QUICK PHILLIPS® 5/16" POWER BITS FOR DRIVERS

58/60 HRC

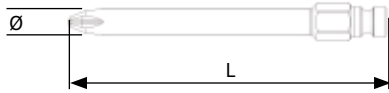

EASYPACK | sacchetto PVC con Euro-hole - PVC bags with Euro-hole

	L mm	Ø mm	PCS.	COD.	€ cad./each
PH1	50	4,5	5	61055005	5,555
	75	4,5	5	61055010	6,608
	100	4,5	5	61055015	8,400
	150	4,5	5	61055020	10,203
PH2	50	6	5	61055025	5,555
	75	6	5	61055030	6,608
	100	6	5	61055035	8,400
PH3	150	6	5	61055040	10,203
	50	8	5	61055045	7,202
	75	8	5	61055050	8,098
	100	8	5	61055055	11,424

61080

PZ - 5/16" RAPIDO

LAME 5/16" RAPIDO POZIDRIV® PER AVVITATORI
QUICK POZIDRIV® 5/16" POWER BITS FOR DRIVERS

58/60 HRC

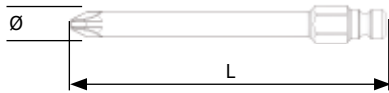

EASYPACK | sacchetto PVC con Euro-hole - PVC bags with Euro-hole

	L mm	Ø mm	PCS.	COD.	€ cad./each
PZ1	50	4,5	5	61080005	5,555
	75	4,5	5	61080010	6,608
	100	4,5	5	61080015	8,400
PZ2	50	6	5	61080020	5,555
	75	6	5	61080025	6,608
	100	6	5	61080030	8,400
PZ3	50	8	5	61080035	7,202
	75	8	5	61080040	8,098
	100	8	5	61080045	11,424

61010

ESAGONO 5/16" RAPIDO

LAME 5/16" RAPIDO ESAGONALI PER AVVITATORI
QUICK 5/16" HEXAGONAL POWER BITS FOR DRIVERS

58/60 HRC

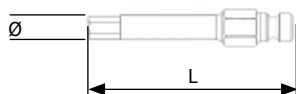

EASYPACK | sacchetto PVC con Euro-hole - PVC bags with Euro-hole

	L mm	Ø mm	PCS.	COD.	€ cad./each
2	70	3	5	61010005	11,099
2,5	70	4	5	61010007	11,099
3	70	4	5	61010010	11,099
4	70	5	5	61010015	11,099
5	70	6	5	61010020	11,099
6	70	7	5	61010025	11,099
7	70	8	5	61010030	11,099
8	70	5/16	5	61010035	11,099
9	70	11	5	61010040	11,099
10	70	12	5	61010045	11,099

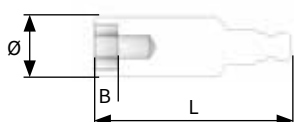
**63008****CHIAVI A BUSSOLA ALTA RESISTENZA - 5/16" RAPIDO****CHIAVI 5/16" RAPIDO A BUSSOLA NON MAGNETICHE ALTA RESISTENZA****QUICK 5/16" NON-MAGNETIC NUT SETTERS HIGH-RESISTANCE****56/58 HRC**

EASYPACK | sacchetto PVC con Euro-hole - PVC bags with Euro-hole

	L mm	Ø mm	B	PCS.	COD.	€ cad./each
7	50	11	4,5	5	63008035	11,760
	75	11	4,5	5	63008040	15,232
	100	11	4,5	5	63008045	16,800
8	50	13	5,5	5	63008050	11,760
	75	13	5,5	5	63008055	15,232
	100	13	5,5	5	63008060	16,800
10	50	15	6,5	5	63008065	12,768
	75	15	6,5	5	63008070	16,464
	100	15	6,5	5	63008075	18,368

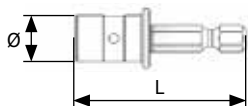
62068**ADATTATORI 1/4"E PER LAME 5/16" RAPIDO****ADATTATORE 1/4"E PER LAME 5/16" RAPIDO****1/4"E ADAPTER FOR QUICK 5/16" POWER BITS**

EASYPACK | sacchetto PVC con Euro-hole - PVC bags with Euro-hole

L mm	Ø mm	PCS.	COD.	€ cad./each
46	17	1	62068005	44,923

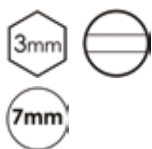

2 INSERTI E CHIAVI SPECIALI BITS AND SPECIAL SETTERS

61031 PH - 3mm

LAME 3mm (A3) PHILLIPS® PER AVVITATORI
PHILLIPS® 3mm (A3) POWER BITS FOR DRIVERS

59/60 HRC



EASYPACK | sacchetto PVC con Euro-hole - PVC bags with Euro-hole

	L mm	Ø mm	PCS.	COD.	€ cad./each
PH1	75	4	5	61031005	16,576
PH2	55	5	5	61031010	13,552

61040 PH - ATTACCO A SPINA

LAME A SPINA PASSANTE PHILLIPS® PER AVVITATORI
PHILLIPS® ROUND DRIVE WITH THROUGH HOLE POWER BITS FOR DRIVERS

59/60 HRC

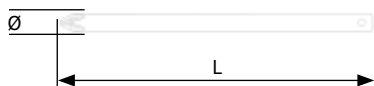

EASYPACK | sacchetto PVC con Euro-hole - PVC bags with Euro-hole

	L mm	Ø mm	PCS.	COD.	€ cad./each
PH1	125	4	5	61040005	19,264
	125	4,5	5	61040010	19,264
	125	5	5	61040015	19,264
	125	5,5	5	61040020	19,264
	125	6	5	61040025	19,264
PH2	125	6,5	5	61040030	19,264
	125	7	5	61040035	19,264
	125	8	5	61040040	22,512



TIPS

Su richiesta realizziamo anche gli adattatori con attacco 1/4" ed innesto alesato. Per avvitatori autoalimentati tipo vegetti.

On request, we also produce adapters with 1/4" attachment and bored coupling. For self-powered screwdrivers.

61066 PZ - ATTACCO A SPINA

LAME A SPINA PASSANTE POZIDRIV® PER AVVITATORI
POZIDRIV® ROUND DRIVE WITH THROUGH HOLE POWER BITS FOR DRIVERS

59/60 HRC

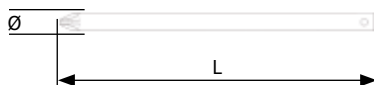

EASYPACK | sacchetto PVC con Euro-hole - PVC bags with Euro-hole

	L mm	Ø mm	PCS.	COD.	€ cad./each
PZ1	125	4	5	61066005	19,264
	125	4,5	5	61066010	19,264
	125	5	5	61066015	19,264
	125	5,5	5	61066020	19,264
	125	6	5	61066025	19,264
PZ2	125	6,5	5	61066030	19,264
	125	7	5	61066035	19,264
	125	8	5	61066040	22,512

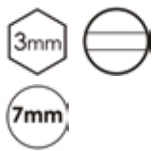

61042 PH DOPPIO - D.7

LAME D.7 DOPPIA IMPRONTA PHILLIPS®
 PHILLIPS® D.7 DOUBLE TIP POWER BITS

58/60 HRC

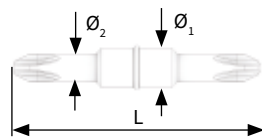

EASYPACK | sacchetto PVC con Euro-hole - PVC bags with Euro-hole

+	L mm	\varnothing_1 mm	\varnothing_2 mm	PCS.	COD.	€ cad./each
1x1	50	7	4,5	5	61042005	12,096
2x2	50	7		5	61042010	12,096
3x3	50	7		5	61042015	12,096

61068 PZ DOPPIO - D.7

LAME D.7 DOPPIA IMPRONTA POZIDRIV®
 POZIDRIV® D.7 DOUBLE TIP POWER BITS

59/61 HRC

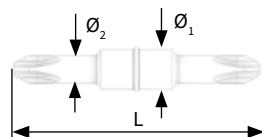

EASYPACK | sacchetto PVC con Euro-hole - PVC bags with Euro-hole

+	L mm	\varnothing_1 mm	\varnothing_2 mm	PCS.	COD.	€ cad./each
1x1	50	7	4,5	5	61068005	12,096
2x2	50	7		5	61068010	12,096

62042 PORTAINSERTI 1/4" E PER INSERTI DOPPI D.7

ADATTATORE 1/4" E PER DOPPI D. 7
 1/4" E ADAPTER FOR D. 7 DOUBLE

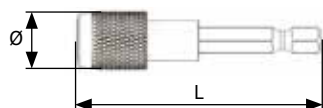

EASYPACK | sacchetto PVC con Euro-hole - PVC bags with Euro-hole

L mm	\varnothing mm	PCS.	COD.	€ cad./each
54	14	1	62042005	37,867



2 INSERTI E CHIAVI SPECIALI

BITS AND SPECIAL SETTERS

63015

CHIAVI 1/4"E PER BUSSOLE FILETTATE

CHIAVI 1/4"E AVVITA BUSSOLE

1/4"E SCREW-IN TOOL FOR COUPLING SLEEVE

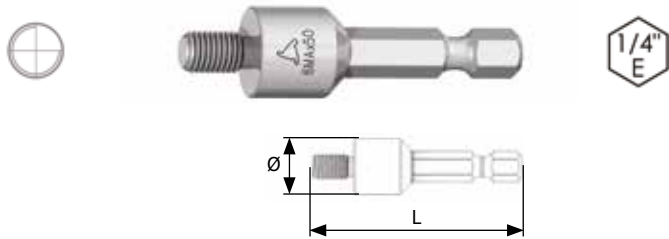

EASYPACK | sacchetto PVC con Euro-hole - PVC bags with Euro-hole

⊕	L mm	Ø mm	PCS.	COD.	€ cad./each
4MA	50	10	5	63015005	28,448
5MA	50	10	5	63015010	28,448
6MA	50	10	5	63015015	28,448
8MA	50	12	5	63015020	28,448
10MA	50	14	5	63015025	28,448

63016

CHIAVI 1/4"E PER BUSSOLE FILETTATE

CHIAVI 1/4"E AVVITA BUSSOLE A SGANCIO RAPIDO

1/4"E QUICK RELEASE SCREW-IN TOOL FOR COUPLING SLEEVE

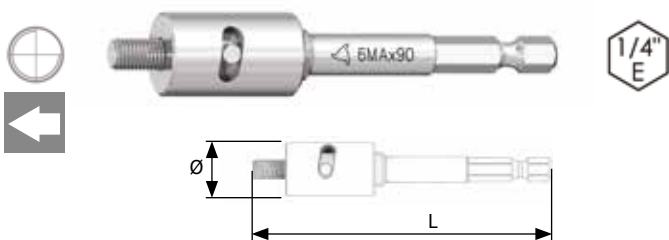

EASYPACK | sacchetto PVC con Euro-hole - PVC bags with Euro-hole

⊕	L mm	Ø mm	PCS.	COD.	€ cad./each
4MA	90	16	1	63016005	45,024
5MA	90	16	1	63016010	45,024
6MA	90	16	1	63016015	45,024
8MA	90	16	1	63016020	45,024
10MA	90	16	1	63016025	45,024



FOCUS ON

①



① In fase di avvitatura la ghiera ruota e si sposta verso la bussola filettata.

②



② In fase di svitamento la ghiera ruota in senso inverso allontanandosi dalla bussola filettata così da liberarla.

① In the phase of screwing, the ring nut rotates and moves toward the threaded socket.

② In the phase of unscrewing, the ring nut rotates in the opposite direction and moves away from the threaded socket, in order to free it.

**63021**

CHIAVI 1/4" E PER PRIGIONIERI FILETTATI

CHIAVI 1/4" E AVVITA PRIGIONIERI
1/4" E INTERNAL TRHEAD INSERTION TOOL

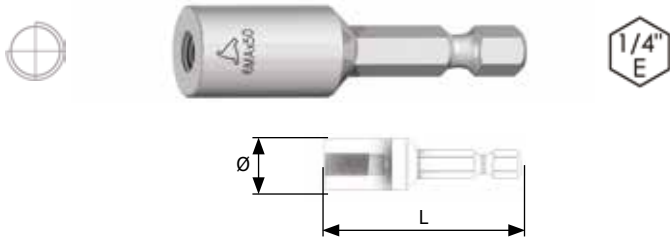

EASYPACK | sacchetto PVC con Euro-hole - PVC bags with Euro-hole

⊕	L mm	Ø mm	PCS.	COD.	€ cad./each
5MA	50	10	5	63021005	28,448
6MA	50	12	5	63021010	28,448
8MA	50	14	5	63021015	28,448
10MA	50	16	5	63021020	28,448

**2****63022**

CHIAVI 1/4" E PER PRIGIONIERI FILETTATI

CHIAVI 1/4" E AVVITA PRIGIONIERI A SGANCIO RAPIDO
1/4" E QUICK RELEASE INTERNAL TRHEAD INSERTION TOOL

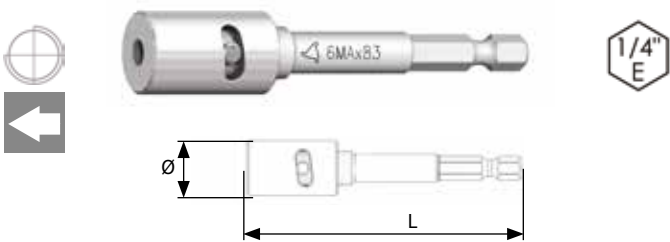

EASYPACK | sacchetto PVC con Euro-hole - PVC bags with Euro-hole

⊕	L mm	Ø mm	PCS.	COD.	€ cad./each
5MA	70	16	1	63022005	48,384
6MA	70	16	1	63022010	48,384
7MA	70	16	1	63022015	48,384
8MA	70	16	1	63022020	48,384
10MA	70	16	1	63022025	48,384



FOCUS ON



① In fase di avvitatura il corpo interno si avvicina al prigioniero bloccandolo in battuta.

② In fase di svitamento il corpo interno si ritrae dalla battuta liberando il prigioniero.

① In the phase of screwing, the inner body moves towards the captive screw, locking it into place.

② In the phase of unscrewing, the inner body withdraws from the stop, freeing the captive screw.



2 INSERTI E CHIAVI SPECIALI

BITS AND SPECIAL SETTERS

62155

ADATTATORI PER PUNTE

ADATTATORI 1/4" E PER PUNTE DA TRAPANO

1/4" E ADAPTERS FOR DRILL BITS



EASYPACK | sacchetto PVC con Euro-hole - PVC bags with Euro-hole

Ø	L mm	PCS.	COD.	€ cad./each
3	50	5	62155005	41,149
4	50	5	62155010	41,149
5	50	5	62155015	41,149



63025

ADATTATORI PER MASCHI

ADATTATORI 1/4" E PER MASCHI

1/4" E ADAPTERS FOR TAPS



EASYPACK | sacchetto PVC con Euro-hole - PVC bags with Euro-hole

Ø	L mm	PCS.	COD.	€ cad./each
3M	50	5	63025005	31,696
4M	50	5	63025010	31,696
5M	50	5	63025015	31,696
6M	50	5	63025020	31,696
8M	50	5	63025025	31,696



FOCUS ON



MASCHIO/TAP

ITEM	DIN352	DIN371	DIN376	DIN374
63025005	M3	M3	M5	M5
63025010	M4	M4	M6	M6
63025015	M5-M8	M5-M6	M8	M8
63025020	M5-M8	M5-M6	M8	M8
63025025		M8		

**63014**

CHIAVI PER CERNIERE ANUBA

CHIAVI 1/4" E PER CERNIERE ANUBA
1/4" E KEY-LOCKS FOR ANUBA HINGENS

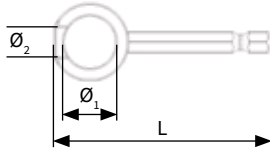

EASYPACK | sacchetto PVC con Euro-hole • PVC bags with Euro-hole

\varnothing_1 mm	L mm	\varnothing_2 mm	PCS.	COD.	€ cad./each
11	62	6	5	63014010	37,520
13	64	8	5	63014015	37,520
14	65	8	5	63014020	37,520

**2**

Installazione di infissi e coperture con cerniera.
Installation of windows and doors with hinges.



2 INSERTI E CHIAVI SPECIALI BITS AND SPECIAL SETTERS

62151

ADATTATORI 1/4" E PER MANDRINI

ADATTATORI 1/4" E PER MANDRINI, CON VITE SINISTRA DI BLOCCO

1/4" E ADAPTERS FOR CHUCKS, WITH LEFT BLOCK SCREWS

EASYPACK | sacchetto PVC con Euro-hole • PVC bags with Euro-hole



	L mm	PCS.	COD.	€ cad./each
3/8" x 24	50	5	62151005	7,922
1/2" x 20	50	5	62151010	9,733

62152

ADATTATORI SDS-PLUS PER MANDRINI

ADATTATORI SDS-PLUS PER MANDRINI, CON VITE SINISTRA DI BLOCCO

SDS-PLUS ADAPTERS FOR CHUCKS, WITH LEFT BLOCK SCREWS

EASYPACK | sacchetto PVC con Euro-hole • PVC bags with Euro-hole

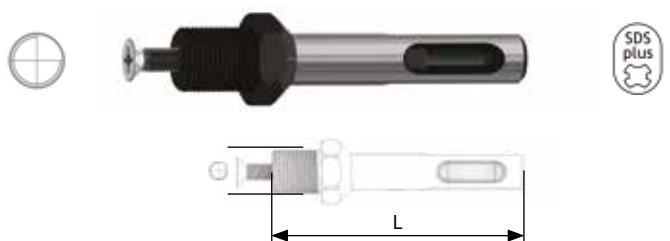

	L mm	PCS.	COD.	€ cad./each
1/2" x 20	65	5	62152005	10,731



62122

ADATTATORI RAPIDO SDS MAX / SDS PLUS®

ADATTATORE SDS-MAX PER PUNTE SDS-PLUS
 SDS-MAX ADAPTER FOR SDS-PLUS DRILL BITS



EASYPACK | sacchetto PVC con Euro-hole - PVC bags with Euro-hole

L mm	PCS.	COD.	€ cad./each
220	1	62122101	88,211

2

62180

RINVII ANGOLARI 90° PROFESSIONALI PER PUNTE

RINVIO AD ANGOLO 90° CON MANDRINO AUTOSERRANTE PER PUNTE
 90° ANGLE DRIVER WITH SELF-LOCKING CHUCK FOR DRILL BITS

max 5000 rpm

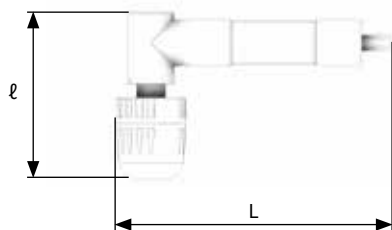
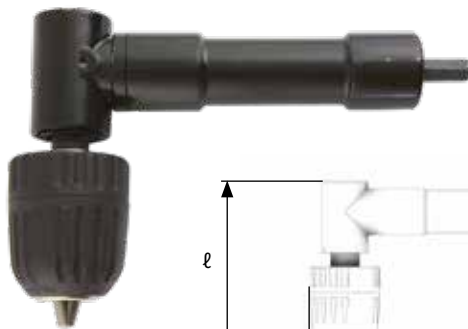

EASYPACK | sacchetto PVC con Euro-hole - PVC bags with Euro-hole

Ø	L mm	l mm	PCS.	COD.	€ cad./each
1,5-10	155	100	1	62180006	55,194



125 X 200 mm



Le bussole con attacco quadro sono l'utensile utilizzato per l'avvitatura nel settore automotive e della carpenteria pesante. Con gli avvitatori a massa battente è indispensabile, anche per motivi di sicurezza, utilizzare bussole ed accessori IMPACT, mentre negli altri casi possono essere utilizzate bussole ed accessori cromati. In questo capitolo presentiamo entrambe le soluzioni, a completamento delle linee di utensili per avvitatori nell'ottica di un servizio adeguato ed esaustivo per tutta la nostra clientela.

Sockets with square attachment are used for screwing applications in the automotive and heavy carpentry industries. With impact wrenches it is essential, also for safety reasons, to use IMPACT sockets and accessories, while standard sockets and accessories can be used in other cases. In this chapter we present both solutions to complement the range of tools for screwdrivers with a view to provide an adequate and exhaustive service.

3

BUSSOLE E ACCESSORI SOCKETS AND ACCESSORIES



BUSSOLE E ACCESSORI IMPACT

SOCKETS AND ACCESSORIES IMPACT



 **3/8"**

p. 281



 **1/2"**

p. 288



 **KMA**

p. 300



 **KM**

p. 303



 **3/4"**

p. 306



 **1"**

p. 312



 **1-1/2"**

p. 316

BUSSOLE E ACCESSORI CHROME

SOCKETS AND ACCESSORIES CHROME



 **1/4"**

p. 321



 **3/8"**

p. 334



 **1/2"**

p. 352



 **3/4"**

p. 372



ASSORTIMENTI
SETS

p. 377

IMPACT

BUSSOLE E ACCESSORI IMPACT *IMPACT sockets and accessories*

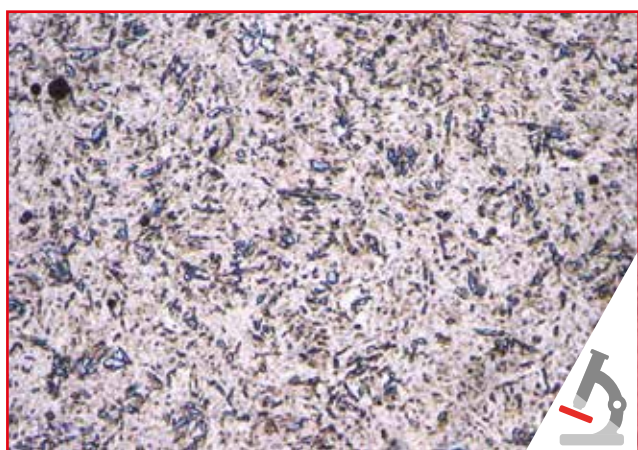
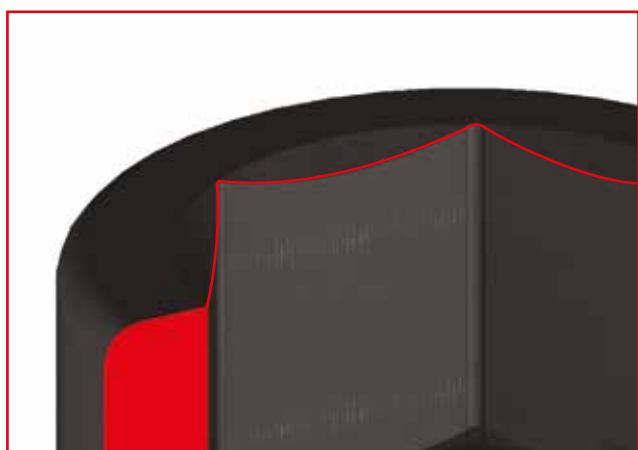

Costruite in acciaio da bonifica al Nickel Cromo Molibdeno, secondo gli standard internazionali. Rivestimento protettivo anti-ossidazione.

Manufactured in Nickel-Chrome-Molybdenum tempered steel, according to international standards. Protective anti-oxidation coating.



Spigoli del quadro e dell'esagono arrotondati per distribuire meglio lo sforzo di torsione e minimizzare il rischio di rottura.

Edges of the square and hexagon are rounded to better distribute torsional stress and minimise the risk of breakage.



Specificatamente indicate per gli usi industriali, con avvitatori ad impulsi e/o a massa battente.

Suitable for industrial use, with pulse and/or impact wrenches.



64011

IMPACT 3/8"

BUSSOLE IMPACT 3/8" CAVA ESAGONALE
3/8" IMPACT SOCKETS 6POINTS HEXAGON RECESS

40/44 HRC

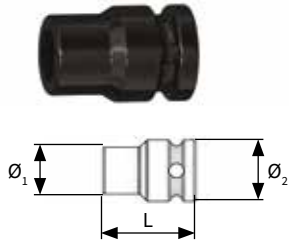

EASYPACK | sacchetto PVC con Euro-hole - PVC bags with Euro-hole

	L mm	Ø ₁ mm	Ø ₂ mm	PCS.	COD.	€ cad./each
7	32	12,5	19	1	64011010	4,260
8	32	13,5	19	1	64011015	4,260
9	32	15	19	1	64011020	4,260
10	32	16	19	1	64011030	4,260
11	32	17,5	19	1	64011035	4,260
12	32	19	19	1	64011045	4,260
13	32	20	22	1	64011055	4,793
14	32	21	22	1	64011060	4,793
15	32	22	22	1	64011070	5,342
16	32	24	22	1	64011080	5,342
17	32	25	22	1	64011085	5,936
18	32	26	22	1	64011095	5,936
19	32	27,5	22	1	64011100	5,936
20	32	28	22	1	64011105	7,112
21	32	30	22	1	64011115	7,112
22	32	32	22	1	64011120	7,616
23	32	32	22	1	64011130	17,920

64011

ASSORTIMENTI BUSSOLE 3/8" IMPACT

SERIE 12 PCS. BUSSOLE 3/8" IMPACT
12 PCS. 3/8" IMPACT SOCKETS SET

12
pcs.

COD. **64011201**
€ 53,400



64011

8	9	10	11	12	13	14	15	16	17	18	19
1pc.	1pc.	1pc.	1pc.	1pc.	1pc.	1pc.	1pc.	1pc.	1pc.	1pc.	1pc.

3



3 BUSSOLE E ACCESSORI

SOCKETS AND ACCESSORIES

64013

IMPACT 3/8" SERIE LUNGA

BUSSOLE IMPACT 3/8" CAVA ESAGONALE - TIPO LUNGO

3/8" IMPACT SOCKETS 6POINTS HEXAGON RECESS - LONG SERIES

40/44 HRC

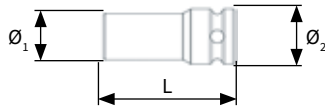

EASYPACK | sacchetto PVC con Euro-hole - PVC bags with Euro-hole

	L mm	Ø ₁ mm	Ø ₂ mm	PCS.	COD.	€ cad./each
6	63	11	19	1	64013005	9,744
7	63	12,5	19	1	64013010	9,744
8	63	14,5	19	1	64013015	7,795
9	63	15	19	1	64013020	7,795
10	63	16	19	1	64013030	7,795
11	63	17,5	19	1	64013035	7,795
12	63	19	19	1	64013045	7,795
13	63	20	22	1	64013055	8,198
14	63	21	22	1	64013060	8,646
15	63	22	22	1	64013070	8,646
16	63	24	22	1	64013080	8,646
17	63	25	22	1	64013085	8,646
18	63	26	22	1	64013095	9,727
19	63	27,5	22	1	64013100	9,727
20	63	28	22	1	64013105	10,483
21	63	30	22	1	64013115	11,340
22	63	32	22	1	64013120	12,600

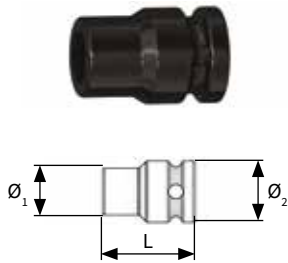
**64015****IMPACT 3/8" MAGNETICHE****BUSSOLE IMPACT 3/8" CAVA ESAGONALE MAGNETICHE**
3/8" IMPACT SOCKETS 6POINTS HEXAGON RECESS WITH MAGNET**40/44 HRC**

EASYPACK | sacchetto PVC con Euro-hole - PVC bags with Euro-hole

	L mm	Ø ₁ mm	Ø ₂ mm	PCS.	COD.	€ cad./each
7	30	12,5	19	1	64015005	6,502
8	30	14,5	19	1	64015010	6,502
9	30	15	19	1	64015015	6,502
10	30	16	19	1	64015020	6,502
11	30	17,5	19	1	64015025	6,502
12	30	19	19	1	64015030	6,502
13	30	19	22	1	64015035	6,502
17	30	25	22	1	64015040	7,207

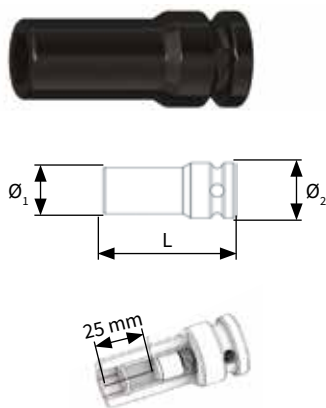
**64017****IMPACT 3/8" SERIE LUNGA MAGNETE RETRTATTILE****BUSSOLE IMPACT 3/8" CAVA ESAGONALE - TIPO LUNGO CON MAGNETE RETRATTILE**
3/8" IMPACT SOCKETS 6POINTS HEXAGON RECESS WITH SLIDING MAGNET- LONG SERIES**40/44 HRC**

EASYPACK | sacchetto PVC con Euro-hole - PVC bags with Euro-hole

	L mm	Ø ₁ mm	Ø ₂ mm	PCS.	COD.	€ cad./each
7	65	12,5	19	1	64017005	40,202
8	65	14,5	19	1	64017010	40,202
9	65	15	19	1	64017015	40,202
10	50	15	19	1	64017025	40,202
10	65	16	19	1	64017030	40,202
11	65	17,5	19	1	64017035	40,202
12	65	19	19	1	64017045	40,202
13	65	19	22	1	64017055	42,369

**3**



3 BUSSOLE E ACCESSORI

SOCKETS AND ACCESSORIES

64125

CAVA TX(E) IMPACT 3/8"

BUSSOLE IMPACT 3/8" CAVA PER VITI TX(E)

3/8" IMPACT SOCKETS RECESS FOR TORX(E) BOLTS AND NUTS

40/44 HRC

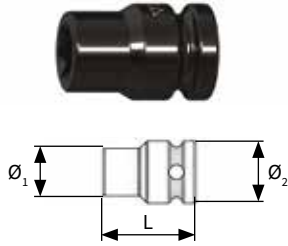

EASYPACK | sacchetto PVC con Euro-hole - PVC bags with Euro-hole

	L mm	Ø ₁ mm	Ø ₂ mm	PCS.	COD.	€ cad./each
E5	32	9	19	1	64125005	10,349
E6	32	10	19	1	64125010	10,349
E7	32	10	19	1	64125015	10,349
E8	32	10,5	19	1	64125020	10,349
E10	32	12,5	19	1	64125025	10,349
E12	32	15	19	1	64125030	10,349
E14	32	17,5	22	1	64125035	10,349
E16	32	19	22	1	64125040	10,349



64133

IMPACT 3/8" CON INSERTO TX FISSATO

BUSSOLE IMPACT 3/8" CON INSERTO PER VITI TORX® FISSATO

3/8" IMPACT SOCKETS WITH FIXED BIT FOR TORX® SCREWS

40/44 HRC

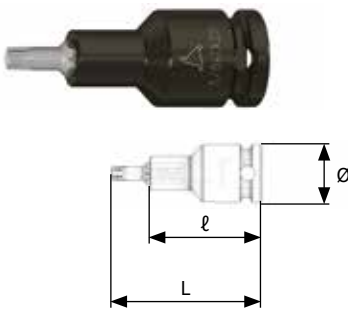

EASYPACK | sacchetto PVC con Euro-hole - PVC bags with Euro-hole

	L mm	l mm	Ø mm	PCS.	COD.	€ cad./each
TX10	50	37	19	1	64133005	11,099
TX15	50	37	19	1	64133015	11,099
TX20	50	37	19	1	64133025	11,099
TX25	50	37	19	1	64133035	11,099
TX27	50	37	19	1	64133045	11,099
TX30	50	37	19	1	64133055	11,099
TX40	50	37	19	1	64133065	11,099
TX45	50	37	19	1	64133075	12,544
TX50	50	37	19	1	64133080	13,216



**64131**

IMPACT 3/8" CON INSERTO ESAGONALE FISSATO

BUSSOLE IMPACT 3/8" CON INSERTO ESAGONALE FISSATO

3/8" IMPACT SOCKETS WITH FIXED HEXAGONAL BIT

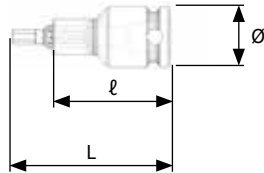
40/44 HRC**EASYPACK** | sacchetto PVC con Euro-hole - PVC bags with Euro-hole

Ø	L mm	l mm	Ø mm	PCS.	COD.	€ cad./each
3	50	37	19	1	64131005	11,099
4	50	37	19	1	64131015	11,099
5	50	37	19	1	64131025	11,099
6	50	37	19	1	64131035	11,099
8	50	37	19	1	64131045	11,099
10	50	37	19	1	64131055	11,099



p. 318

64132

IMPACT 3/8" CON INSERTO ESAGONALE SFERICO FISSATO

BUSSOLE IMPACT 3/8" CON INSERTO ESAGONALE IMPRONTA TIPO SFERICO FISSATO

3/8" IMPACT SOCKETS WITH FIXED HEXAGONAL BALL BIT

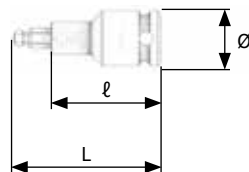
40/44 HRC**EASYPACK** | sacchetto PVC con Euro-hole - PVC bags with Euro-hole

Ø	L mm	l mm	Ø mm	PCS.	COD.	€ cad./each
3	50	37	19	1	64132005	12,208
4	50	37	19	1	64132015	12,208
5	50	37	19	1	64132025	12,208
6	50	37	19	1	64132035	12,208



p. 318

3



3 BUSSOLE E ACCESSORI

SOCKETS AND ACCESSORIES

62181

PROLUNGHE

PROLUNGA IMPACT PER BUSSOLE 3/8"
IMPACT EXTENSION FOR 3/8" SOCKETS

40/44 HRC



EASYPACK | sacchetto PVC con Euro-hole - PVC bags with Euro-hole

L mm	A/B/C	Ø mm	PCS.	COD.	€ cad./each
75	A	19	1	62181010	11,290
75	B	19	1	62181015	11,290
100	A	19	1	62181025	18,032
150	A	19	1	62181055	15,758
150	B	19	1	62181060	15,758
200	A	19	1	62181070	18,267



62183

PROLUNGHE SNODATE

PROLUNGA IMPACT SNODATE PER BUSSOLE 3/8"
IMPACT UNIVERSAL JOINT FOR 3/8" SOCKETS

40/44 HRC



EASYPACK | sacchetto PVC con Euro-hole - PVC bags with Euro-hole

L mm	A/B/C	Ø mm	PCS.	COD.	€ cad./each
48	C	19	1	62183005	21,168
48	A	19	1	62183010	21,168



62184

PROLUNGHE SNODATE CON BLOCCO

PROLUNGA IMPACT SNODATA PER BUSSOLE 3/8" - CON BLOCCO
IMPACT UNIVERSAL JOINT FOR 3/8" SOCKETS - WITH LOCK

40/44 HRC



EASYPACK | sacchetto PVC con Euro-hole - PVC bags with Euro-hole

L mm	A/B/C	Ø mm	PCS.	COD.	€ cad./each
90	B	19	1	62184005	11,917

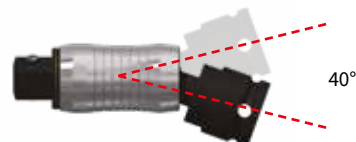

**62182**

PROLUNGHE SGANCIO RAPIDO

PROLUNGA IMPACT PER BUSSOLE 3/8" - CON SGANCIO RAPIDO

IMPACT EXTENSION FOR 3/8" SOCKETS - WITH QUICK RELEASE

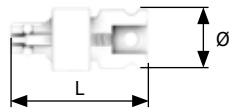
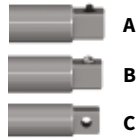
40/44 HRC

EASYPACK | sacchetto PVC con Euro-hole - PVC bags with Euro-hole

L mm	A/B/C	Ø mm	PCS.	COD.	€ cad./each
46	B	20	1	62182005	103,219

**62104**

RIDUZIONI

RIDUZIONE IMPACT 3/8" PER BUSSOLE DA 1/4"

3/8" IMPACT REDUCTION FOR 1/4" SOCKETS

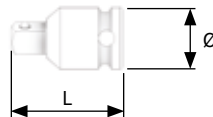
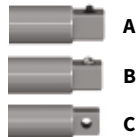
40/44 HRC

EASYPACK | sacchetto PVC con Euro-hole - PVC bags with Euro-hole

L mm	A/B/C	Ø mm	PCS.	COD.	€ cad./each
25	A	19	1	62104005	11,553
25	B	19	1	62104010	11,553

**62124**

ADATTATORI/AUMENTATORI

ADATTATORE/AUMENTATORE IMPACT 3/8" PER BUSSOLE DA 1/2"

3/8" IMPACT ADAPTER/INCREASER FOR 1/2" SOCKETS

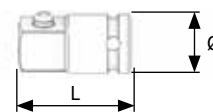
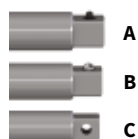
40/44 HRC

EASYPACK | sacchetto PVC con Euro-hole - PVC bags with Euro-hole

L mm	A/B/C	Ø mm	PCS.	COD.	€ cad./each
38	C	19	1	62124005	11,630
38	B	19	1	62124010	11,630





3 BUSSOLE E ACCESSORI

SOCKETS AND ACCESSORIES

64031

IMPACT 1/2"

BUSSOLE IMPACT 1/2" CAVA ESAGONALE

1/2" IMPACT SOCKETS 6 POINTS HEXAGON RECESS

40/44 HRC

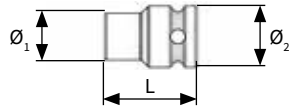

EASYPACK | sacchetto PVC con Euro-hole - PVC bags with Euro-hole

	L mm	Ø ₁ mm	Ø ₂ mm	PCS.	COD.	€ cad./each
8	38	14,5	25	1	64031005	5,242
9	38	15,7	25	1	64031010	5,242
10	38	17	25	1	64031020	5,242
11	38	18,2	25	1	64031025	5,242
12	38	19,5	25	1	64031035	5,242
13	38	20,7	25	1	64031045	5,242
14	38	22	25	1	64031050	5,242
15	38	23,2	30	1	64031060	5,796
16	38	24,5	30	1	64031070	5,796
17	38	25,7	30	1	64031075	5,796
18	38	27	30	1	64031085	6,440
19	38	28,2	30	1	64031090	6,440
20	38	30	30	1	64031095	7,728
21	38	30	30	1	64031105	7,728
22	38	32	30	1	64031110	8,232
23	38	34	30	1	64031120	8,904
24	38	34	30	1	64031130	9,688
25	43	36	30	1	64031135	10,657
26	43	36	30	1	64031145	11,396
27	43	38	30	1	64031150	11,872
28	43	41	30	1	64031155	12,376
29	43	40	30	1	64031165	12,376
30	43	42	30	1	64031170	13,888
32	43	44	30	1	64031185	13,888
37	50	52	38	1	64031220	23,038
38	50	52	38	1	64031225	24,024

64031

ASSORTIMENTI BUSSOLE 1/2" IMPACT

SERIE 12 PCS. BUSSOLE 1/2" IMPACT IN CASSETTA METALLICA

12 PCS. 1/2" IMPACT SOCKETS SET WITH METAL CASE



12
pcs.

COD. **64031301**

€ 86,400

64031

10	11	12	13	14	17	19	22	24	27	30	32
1pc.	1pc.	1pc.	1pc.	1pc.	1pc.	1pc.	1pc.	1pc.	1pc.	1pc.	1pc.

**64033****IMPACT 1/2" SERIE LUNGA****BUSSOLE IMPACT 1/2" CAVA ESAGONALE - TIPO LUNGO**

1/2" IMPACT SOCKETS 6 POINTS HEXAGON RECESS - LONG SERIES

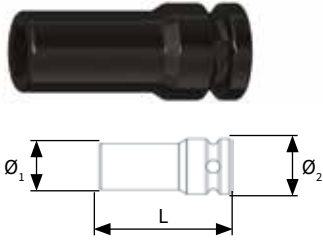
40/44 HRC

EASYPACK | sacchetto PVC con Euro-hole - PVC bags with Euro-hole

	L mm	Ø ₁ mm	Ø ₂ mm	PCS.	COD.	€ cad./each
8	78	14,5	25	1	64033005	9,475
9	78	15,7	25	1	64033010	9,475
10	78	17	25	1	64033020	9,475
11	78	18,2	25	1	64033025	9,475
12	78	19,5	25	1	64033035	9,475
13	78	20,7	25	1	64033045	10,030
14	78	22	25	1	64033050	10,030
15	78	23,2	30	1	64033060	10,534
16	78	24,5	30	1	64033070	10,534
17	78	25,7	30	1	64033075	10,534
18	78	27	30	1	64033085	10,534
19	78	28,2	30	1	64033090	11,704
20	78	30	30	1	64033095	11,390
21	78	30	30	1	64033105	12,348
22	78	32	30	1	64033110	12,348
23	78	34	30	1	64033120	12,751
24	78	34	30	1	64033130	13,406
25	78	36	30	1	64033135	15,120
26	78	36	30	1	64033145	16,800
27	78	38	30	1	64033150	16,800
28	78	40	30	1	64033155	18,480
29	78	40	30	1	64033165	19,858
30	78	42	30	1	64033170	19,858
31	78	44	30	1	64033175	23,352
32	78	44	30	1	64033185	23,352
33	80	45	30	1	64033190	24,528
34	80	49	35	1	64033200	24,528
35	80	49	38	1	64033205	27,384
36	80	49	35	1	64033210	27,384
37	80	52	38	1	64033220	30,184

64033**ASSORTIMENTI BUSSOLE 1/2" IMPACT LUNGHE****SERIE 12 PCS. BUSSOLE 1/2" IMPACT TIPO LUNGO IN CASSETTA MATAALICA**

12 PCS. 1/2" IMPACT SOCKETS LONG SERIES SET WITH METAL CASE

12
pcs.COD. **64033301**

€ 140,800



64033

10	11	12	13	14	17	19	22	24	27	30	32
1pc.	1pc.	1pc.	1pc.	1pc.	1pc.	1pc.	1pc.	1pc.	1pc.	1pc.	1pc.



3 BUSSOLE E ACCESSORI

SOCKETS AND ACCESSORIES

64034

IMPACT 1/2" X CERCHI LEGA

BUSSOLE IMPACT 1/2" RIVESTITE PER CERCHI LEGA

1/2" IMPACT SOCKETS WITH PLASTIC COVER FOR WHEELS

40/44 HRC

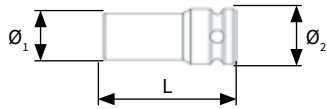

EASYPACK | sacchetto PVC con Euro-hole - PVC bags with Euro-hole

	L mm	Ø ₁ mm	Ø ₂ mm	PCS.	COD.	€ cad./each
17	78	27	30	1	64034075	10,111
19	78	29	30	1	64034090	10,818
21	78	31	30	1	64034105	11,525
22	78	33	32	1	64034110	12,939
24	78	35	34	1	64034130	18,507

64330

ASSORTIMENTI BUSSOLE IMPACT 1/2" X CERCHI LEGA

SET 3 PZ. BUSSOLE IMPACT 1/2" RIVESTITE PER CERCHI LEGA

3 PCS. 1/2" IMPACT SOCKETS WITH PLASTIC COVER FOR WHEELS SET



3
pcs.

COD: **64330002**

€ 32,200

64034		
17 1pc.	19 1pc.	21 1pc.

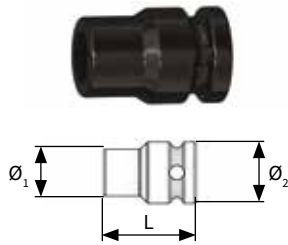
**64035****IMPACT 1/2" MAGNETICHE****BUSSOLE IMPACT 1/2" CAVA ESAGONALE MAGNETICHE**
1/2" IMPACT SOCKETS 6POINTS HEXAGON RECESS WITH MAGNET**40/44 HRC**

EASYPACK | sacchetto PVC con Euro-hole - PVC bags with Euro-hole

Ø	L mm	Ø ₁ mm	Ø ₂ mm	PCS.	COD.	€ cad./each
10	38	17	25	1	64035005	7,840
12	38	20	25	1	64035010	7,840
13	38	21	25	1	64035015	7,840
15	38	24	25	1	64035020	9,959
17	38	26	30	1	64035025	9,959
19	38	27,5	30	1	64035030	9,959
20	38	30	30	1	64035035	10,416
22	38	32	30	1	64035040	11,088
24	45	35	30	1	64035045	13,048

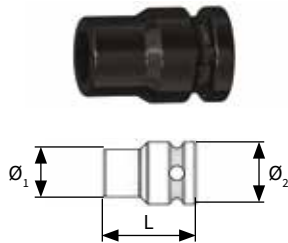
**64040****IMPACT 1/2" PARETI SOTTILI****BUSSOLE IMPACT 1/2" CAVA ESAGONALE - PARETI SOTTILI**
1/2" HEXAGONAL RECESS IMPACT SOCKETS - THIN WALLS**40/44 HRC**

EASYPACK | sacchetto PVC con Euro-hole - PVC bags with Euro-hole

Ø	L mm	Ø ₁ mm	Ø ₂ mm	PCS.	COD.	€ cad./each
13	38	20,5	25	1	64040005	16,240
14	38	21,5	25	1	64040010	16,240
15	38	23,5	30	1	64040020	16,240
16	38	24,5	30	1	64040030	18,032
17	38	25	30	1	64040035	18,032
18	38	25	30	1	64040045	18,032
19	38	27	30	1	64040050	18,032
20	38	28	30	1	64040055	22,624
21	38	29,5	30	1	64040065	23,184
22	38	30	30	1	64040070	23,744
23	38	31,5	30	1	64040080	25,536
24	38	33	30	1	64040090	27,888

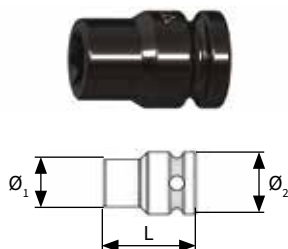
**64126****CAVA TX(E) IMPACT 1/2"****BUSSOLE IMPACT 1/2" CAVA PER VITI TX(E)**
1/2" IMPACT SOCKETS RECESS FOR TORX(E) BOLTS AND NUTS**40/44 HRC**

EASYPACK | sacchetto PVC con Euro-hole - PVC bags with Euro-hole

Ø	L mm	Ø ₁ mm	Ø ₂ mm	PCS.	COD.	€ cad./each
E10	40	14	25	1	64126005	13,328
E11	40	15,5	25	1	64126010	13,328
E12	40	16	25	1	64126015	13,328
E14	40	18	25	1	64126020	13,328
E16	40	20	25	1	64126025	13,328
E18	40	22	25	1	64126030	13,328
E20	40	24	30	1	64126035	17,248
E22	40	26	30	1	64126040	17,248
E24	40	30	30	1	64126045	17,248





3 BUSSOLE E ACCESSORI

SOCKETS AND ACCESSORIES

64137

IMPACT 1/2" INTEGRALE ESAGONO MASCHIO

BUSSOLE IMPACT 1/2" ESAGONO MASCHIO INTEGRALI

1/2" IMPACT SOCKETS ONE-PIECE MALE HEXAGON

40/44 HRC

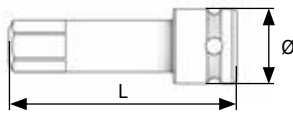

EASYPACK | sacchetto PVC con Euro-hole - PVC bags with Euro-hole

Ø	L mm	Ø mm	PCS.	COD.	€ cad./each
5	60	25	1	64137005	12,074
6	60	25	1	64137010	12,074
7	60	25	1	64137020	12,074
8	60	25	1	64137030	12,074
10	60	25	1	64137045	12,074
12	60	30	1	64137060	12,074
14	60	30	1	64137075	12,074
17	60	30	1	64137100	12,074
19	60	30	1	64137110	12,074



64137

ASSORTIMENTI BUSSOLE 1/2" MASCHIO ESAGONALE

SERIE 9 PCS. BUSSOLE 1/2" INTEGRALI MASCHIO ESAGONALE IN CASSETTA METALLICA

9PCS. SE 1/2" IMPACT SOCKETS ONE-PIECE MALE HEXAGON WITH METAL CASE



9
pcs.

COD. **64137301**

€ 97,800

64137

5	6	7	8	10	12	14	17	19
1pc.	1pc.	1pc.	1pc.	1pc.	1pc.	1pc.	1pc.	1pc.

**64138**

IMPACT 1/2" INTEGRALE MASCHIO TX

BUSSOLE IMPACT 1/2" INTEGRALI MASCHIO TX

1/2" IMPACT SOCKETS ONE-PIECE MALE TX

40/44 HRC



EASYPACK | sacchetto PVC con Euro-hole - PVC bags with Euro-hole

	L mm	Ø mm	PCS.	COD.	€ cad./each
TX25	60	25	1	64138005	12,150
TX27	60	25	1	64138010	12,150
TX30	60	25	1	64138015	12,150
TX40	60	25	1	64138020	12,150
TX45	60	25	1	64138025	12,150
TX50	60	30	1	64138030	12,150
TX55	60	30	1	64138035	12,150
TX60	60	30	1	64138040	12,150
TX70	60	30	1	64138045	12,150

3**64138**

ASSORTIMENTI BUSSOLE 1/2" MASCHIO TX

SERIE 9 PCS. BUSSOLE 1/2" INTEGRALI MASCHIO TX IN CASSETTA METALLICA

9PCS. SE 1/2" IMPACT SOCKETS ONE-PIECE MALE TX WITH METAL CASE



9
pcs.

COD. **64138301**

€ 98,400

64138

TX25	TX27	TX30	TX40	TX45	TX50	TX55	TX60	TX70
1pc.	1pc.	1pc.	1pc.	1pc.	1pc.	1pc.	1pc.	1pc.



3 BUSSOLE E ACCESSORI SOCKETS AND ACCESSORIES

64136

IMPACT 1/2" CON INSERTO TX FISSATO

BUSSOLE IMPACT 1/2" CON INSERTO PER VITI TORX® FISSATO

1/2" IMPACT SOCKETS WITH FIXED BIT FOR TORX® SCREWS

40/44 HRC

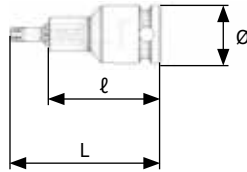

EASYPACK | sacchetto PVC con Euro-hole - PVC bags with Euro-hole

	L mm	ℓ mm	Ø mm	PCS.	COD.	€ cad./each
TX20	55	32	25	1	64136005	27,552
TX25	55	32	25	1	64136010	27,552
TX27	55	32	25	1	64136015	27,552
TX30	55	32	25	1	64136020	27,552
TX40	55	32	25	1	64136025	27,552
TX45	55	32	25	1	64136030	27,552
TX50	55	32	25	1	64136035	27,552
TX55	55	32	25	1	64136040	29,008



64135

IMPACT 1/2" CON INSERTO ESAGONALE FISSATO

BUSSOLE IMPACT 1/2" CON INSERTO ESAGONALE FISSATO

1/2" IMPACT SOCKETS WITH FIXED HEXAGONAL BIT

40/44 HRC

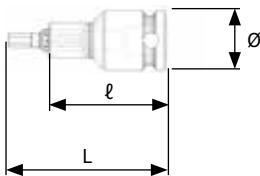

EASYPACK | sacchetto PVC con Euro-hole - PVC bags with Euro-hole

	L mm	ℓ mm	Ø mm	PCS.	COD.	€ cad./each
5	55	32	25	1	64135005	27,216
6	55	32	25	1	64135010	27,216
8	55	32	25	1	64135020	27,216
10	55	32	25	1	64135025	27,776

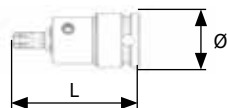

**64183****IMPACT 1/2" CON INSERTO TX****BUSSOLE IMPACT 1/2" CON INSERTO PER VITI TORX® ESTRAIBILE****1/2" IMPACT SOCKETS WITH EXTRACTABLE BIT FOR TORX® SCREWS****40/44 HRC**

EASYPACK| sacchetto PVC con Euro-hole - PVC bags with Euro-hole

	L mm	Ø mm	PCS.	COD.	€ cad./each
TX30	54	25	1	64183005	20,496
TX40	54	25	1	64183010	20,496
TX50	57	25	1	64183015	21,952
TX55	57	25	1	64183020	25,984
TX60	57	30	1	64183025	25,984
TX70	57	30	1	64183030	56,784

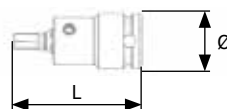
**64181****IMPACT 1/2" CON INSERTO ESAGONALE****BUSSOLE IMPACT 1/2" CON INSERTO ESAGONALE ESTRAIBILE****1/2" IMPACT SOCKETS WITH EXTRACTABLE HEXAGONAL BIT****40/44 HRC**

EASYPACK| sacchetto PVC con Euro-hole - PVC bags with Euro-hole

	L mm	Ø mm	PCS.	COD.	€ cad./each
5	54	25	1	64181005	19,040
6	54	25	1	64181010	19,040
8	57	25	1	64181015	19,040
10	57	30	1	64181020	25,200
12	57	30	1	64181025	25,200
14	57	30	1	64181030	25,200
17	57	30	1	64181035	35,168
19	75	30	1	64181040	35,168
22	75	30	1	64181045	35,168

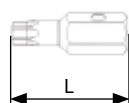
**64184****INSERTI TX PER BUSSOLE IMPACT 1/2"****INSERTI PER VITI TORX® DI RICAMBIO PER BUSSOLE****TORX® SCREWS SPARE BITS FOR SOCKETS****40/44 HRC**

EASYPACK| sacchetto PVC con Euro-hole - PVC bags with Euro-hole

	L mm	E	PCS.	COD.	€ cad./each
TX30	32	11	1	64184005	6,698
TX40	32	11	1	64184010	6,698
TX50	35	11	1	64184015	8,098
TX55	35	16	1	64184020	8,098
TX60	35	16	1	64184025	8,098
TX70	35	16	1	64184030	38,864



3 BUSSOLE E ACCESSORI

SOCKETS AND ACCESSORIES

64182

INSERTI ESAGONALI PER BUSSOLE IMPACT 1/2"

INSERTI ESAGONALI DI RICAMBIO PER BUSSOLE
 HEXAGONAL SPARE BITS FOR SOCKETS

40/44 HRC

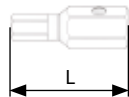

EASYPACK | sacchetto PVC con Euro-hole - PVC bags with Euro-hole

	L mm	E	PCS.	COD.	€ cad./each
5	32	11	1	64182005	5,197
6	32	11	1	64182010	5,197
8	35	11	1	64182015	5,197
10	35	16	1	64182020	7,381
12	35	16	1	64182025	7,381
14	35	16	1	64182030	7,381
17	51	22	1	64182035	12,992
19	51	22	1	64182040	12,992
22	51	22	1	64182070	12,992

64185

BUSSOLE IMPACT 1/2" PER INSERTI

BUSSOLE IMPACT 1/2" PORTA INSERTI, CON GRANO
 1/2" IMPACT SOCKETS BIT-HOLDER, WITH GRAIN

40/44 HRC

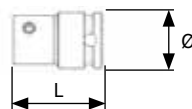

EASYPACK | sacchetto PVC con Euro-hole - PVC bags with Euro-hole

	L mm	Ø mm	PCS.	COD.	€ cad./each
11	35	25	1	64185005	13,888
16	35	30	1	64185010	17,808
22	40	30	1	64185015	22,064



**62191**

PROLUNGHE

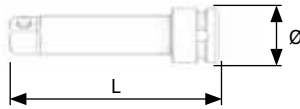
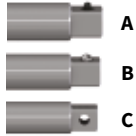
PROLUNGA IMPACT PER BUSSOLE 1/2"
IMPACT EXTENSION FOR 1/2" SOCKETS**40/44 HRC**

EASYPACK | sacchetto PVC con Euro-hole - PVC bags with Euro-hole

L mm	A/B/C	Ø mm	PCS.	COD.	€ cad./each
75	C	25	1	62191015	13,863
75	A	25	1	62191005	13,863
75	B	25	1	62191010	13,863
125	C	25	1	62191030	17,873
125	A	25	1	62191020	17,926
125	B	25	1	62191025	17,864
250	C	25	1	62191055	22,958
250	A	25	1	62191045	23,038
250	B	25	1	62191050	23,038

62193

PROLUNGHE SNODATE

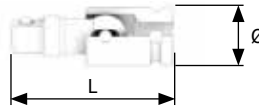
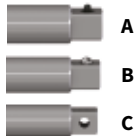
PROLUNGA IMPACT SNODATA PER BUSSOLE 1/2"
IMPACT UNIVERSAL JOINT FOR 1/2" SOCKETS**40/44 HRC**

EASYPACK | sacchetto PVC con Euro-hole - PVC bags with Euro-hole

L mm	A/B/C	Ø mm	PCS.	COD.	€ cad./each
63	C	25	1	62193005	28,728
63	A	25	1	62193010	28,728
63	B	25	1	62193015	28,728

3



3 BUSSOLE E ACCESSORI

SOCKETS AND ACCESSORIES

62192

PROLUNGHE SGANCIO RAPIDO

PROLUNGA IMPACT PER BUSSOLE 1/2" - CON SGANCIO RAPIDO
IMPACT EXTENSION FOR 1/2" SOCKETS - WITH QUICK RELEASE

40/44 HRC

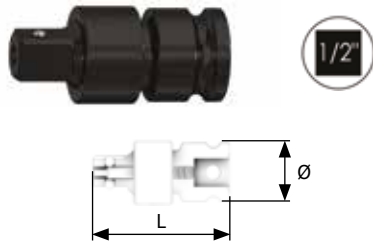
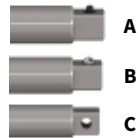

EASYPACK | sacchetto PVC con Euro-hole - PVC bags with Euro-hole

L mm	A/B/C	Ø mm	PCS.	COD.	€ cad./each
60	B	20	1	62192005	130,222



62116

RIDUZIONI

RIDUZIONE IMPACT 1/2" PER BUSSOLE DA 3/8"
1/2" IMPACT REDUCTION FOR 3/8" SOCKETS

40/44 HRC

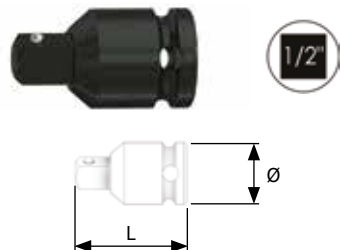
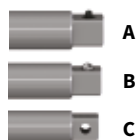

EASYPACK | sacchetto PVC con Euro-hole - PVC bags with Euro-hole

L mm	A/B/C	Ø mm	PCS.	COD.	€ cad./each
36	A	25	1	62116005	12,141
36	B	25	1	62116010	12,141
36	C	25	1	62116015	12,141
150	B	25	1	62116025	45,696



62135

ADATTATORI/AUMENTATORI

ADATTATORE/AUMENTATORE IMPACT 1/2" PER BUSSOLE DA 3/4"
1/2" IMPACT ADAPTER/INCREASER FOR 3/4" SOCKETS

40/44 HRC

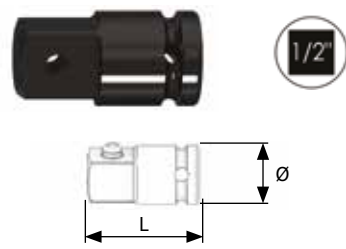
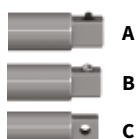

EASYPACK | sacchetto PVC con Euro-hole - PVC bags with Euro-hole

L mm	A/B/C	Ø mm	PCS.	COD.	€ cad./each
48	C	30	1	62135005	16,884





3

Dettaglio di un'impianto di trasformazione degli idrocarburi.
Detail of a hydrocarbon transformation system.



3 BUSSOLE E ACCESSORI

SOCKETS AND ACCESSORIES

64101

BUSSOLE DENTI ESTERNI PER GHIERE AUTOBLOCCANTI-KMA

BUSSOLE PER GHIERE FILETTATE AUTOBLOCCANTI, DENTI ESTERNI
SOCKETS FOR SELF-LOCKING THREADED NUTS, EXTERNAL TEETH

40/44 HRC

EASYPACK | sacchetto PVC con Euro-hole - PVC bags with Euro-hole



KMA	Ø ₁ mm	Ø ₂ mm	PCS.	COD.	€ cad./each
3/8" 0	15,5	20	1	64101005	43,680
3/8" 1	19	24	1	64101010	43,680
1/2" 2	22	27	1	64101015	49,728
1/2" 3	25	30	1	64101020	52,752
1/2" 4	28	36	1	64101025	57,680
1/2" 5	34	42	1	64101030	58,800
1/2" 6	39	48	1	64101035	60,592
1/2" 7	45	54	1	64101040	64,848
1/2" 8	51	61	1	64101045	65,520
3/4" 9	56	67	1	64101050	78,848
3/4" 10	62	73	1	64101055	84,896
3/4" 11	69	82	1	64101060	102,480
3/4" 12	74	87	1	64101065	116,480
3/4" 13	78	92	1	64101070	145,488
3/4" 14	85,5	98	1	64101075	169,792



DIMENSIONI GHIERE | lock-nuts dimensions

M	KMA	Ø ₁ mm	Ø ₂ mm	
M10x0,75	0	14	18	4
M12x1	1	18	22	4
M15x1	2	21	25	4
M17x1	3	24	28	4
M20x1	4	27	32	4
M25x1,5	5	33	38	4
M30x1,5	6	38	44	4
M35x1,5	7	44	50	4
M40x1,5	8	50	56	4
M45x1,5	9	55	62	4
M50x1,5	10	61	68	4
M55x2	11	68	75	6
M60x2	12	73	80	6
M65x2	13	77	85	6
M70x2	14	84	92	6

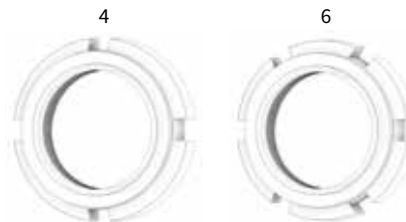
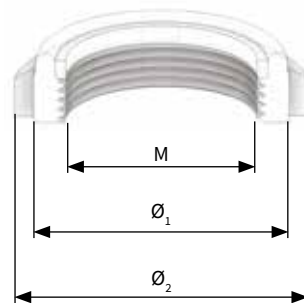

FOCUS ON



Le ghiera filettate autobloccanti (KMA - GUK - GUP) si riconoscono dalla presenza di un anello interno di nylon che, al momento dell'avvitamento, crea un effetto bloccante tra vite e madre-vite.

The self-locking threaded ring nuts (KMA - GUK - GUP) are recognised by the presence of an inner nylon ring that, at the time of screwing, creates a blocking effect between the screw and mother-screw.



64102

BUSSOLE DENTI INTERNI PER GHIERE AUTOBLOCCANTI-KMA

BUSSOLE PER GHIERE FILETTATE AUTOBLOCCANTI, DENTI INTERNI
SOCKETS FOR SELF-LOCKING THREADED NUTS, INTERNAL TEETH

40/44 HRC

EASYPACK | sacchetto PVC con Euro-hole - PVC bags with Euro-hole

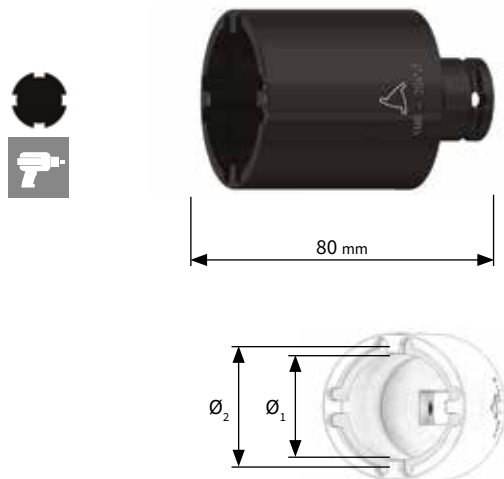

	KMA	Ø ₁ mm	Ø ₂ mm	PCS.	COD.	€ cad./each
3/8"	0	15,5	18,5	1	64102005	62,496
3/8"	1	19	22,5	1	64102010	62,496
1/2"	2	22	25,5	1	64102015	74,928
1/2"	3	25	29	1	64102020	81,200
1/2"	4	28	33	1	64102025	87,472
1/2"	5	34	39	1	64102030	93,632
1/2"	6	39	46	1	64102035	99,904
1/2"	7	45	53	1	64102040	112,336
1/2"	8	51	59	1	64102045	118,720
3/4"	9	56	66	1	64102050	131,152
3/4"	10	62	71	1	64102055	137,312
3/4"	11	69	76	1	64102060	152,992
3/4"	12	74	81	1	64102065	162,288
3/4"	13	78	86	1	64102070	209,104



DIMENSIONI BUSSOLE | sockets dimensions

M	KMA	S	H	P	
M10x0,75	0	2,5	5	65	4
M12x1	1	2,5	5	65	4
M15x1	2	3,5	6	65	4
M17x1	3	3,5	6	65	4
M20x1	4	3,5	7	60	4
M25x1,5	5	4,5	7	60	4
M30x1,5	6	4,5	7	60	4
M35x1,5	7	4,5	8	45	4
M40x1,5	8	5,5	9	45	4
M45x1,5	9	5,5	9	35	4
M50x1,5	10	5,5	9	35	4
M55x2	11	6,5	9	35	6
M60x2	12	6,5	9	35	6
M65x2	13	6,5	10	35	6
M70x2	14	7,0	10	35	6

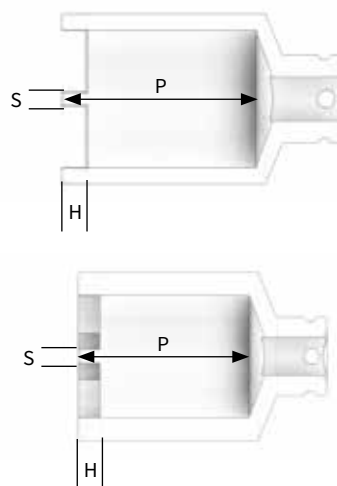



3 BUSSOLE E ACCESSORI

SOCKETS AND ACCESSORIES

64103

ASSORTIMENTI BUSSOLE PER GHIERE AUTOBLOCCANTI-KMA

ASSORTIMENTI 11 PCS. BUSSOLE PER GHIERE AUTOBLOCCANTI
KIT WITH 11 SOCKETS FOR SELF-LOCKING NUTS



250 X 120 X 180 mm

11
pcs.

COD. **64103005**
€ 701,904

64101 KMA

0	1	2	3	4	5	6	7	8	9	10
1pc.	1pc.	1pc.	1pc.	1pc.	1pc.	1pc.	1pc.	1pc.	1pc.	1pc.

COD. **64103010**
€ 1.102,304

64102 KMA

0	1	2	3	4	5	6	7	8	9	10
1pc.	1pc.	1pc.	1pc.	1pc.	1pc.	1pc.	1pc.	1pc.	1pc.	1pc.

64104

ESPOSITORE BUSSOLE PER GHIERE AUTOBLOCCANTI-KMA

ESPOSITORE 11 PCS. BUSSOLE PER GHIERE AUTOBLOCCANTI
DISPLAY WITH 11 SOCKETS FOR SELF-LOCKING NUTS



240 X 150 X 205 mm

11
pcs.

COD. **64104005**
€ 802,368

64101 KMA

0	1	2	3	4	5	6	7	8	9	10
1pc.	1pc.	1pc.	1pc.	1pc.	1pc.	1pc.	1pc.	1pc.	1pc.	1pc.

COD. **64104010**
€ 1.202,768

64102 KMA

0	1	2	3	4	5	6	7	8	9	10
1pc.	1pc.	1pc.	1pc.	1pc.	1pc.	1pc.	1pc.	1pc.	1pc.	1pc.



64105



BUSSOLE DENTI ESTERNI PER GHIERE KM

BUSSOLE PER GHIERE FILETTATE, DENTI ESTERNI
SOCKETS FOR THREADED NUTS, EXTERNAL TEETH

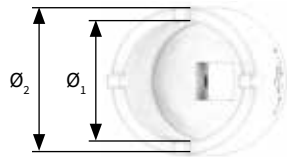
40/44 HRC





EASYPACK | sacchetto PVC con Euro-hole - PVC bags with Euro-hole

			Ø ₁ mm	Ø ₂ mm	PCS.	COD.	€ cad./each
3/8"	0	KM	15,5	20	1	64105005	43,680
3/8"	1		19	24	1	64105010	43,680
1/2"	2		22	27	1	64105015	49,728
1/2"	3		25	30	1	64105020	52,752
1/2"	4		29	36	1	64105025	57,680
1/2"	5		35	42	1	64105030	58,800
1/2"	6		42	49	1	64105035	60,592
1/2"	7		49	56	1	64105040	64,848
1/2"	8		54	63	1	64105045	65,520
3/4"	9		61	70	1	64105050	78,848
3/4"	10		66	75	1	64105055	84,896
3/4"	11		70	82	1	64105060	102,480
3/4"	12		75	87	1	64105065	116,480
3/4"	13		80	92	1	64105070	145,488
3/4"	14		86	98	1	64105075	169,792



DIMENSIONI GHIERE | lock-nuts dimensions

M		Ø ₁ mm	Ø ₂ mm	
M10x0,75	0	14	18	4
M12x1	1	18	22	4
M15x1	2	21	25	4
M17x1	3	24	28	4
M20x1	4	28	32	4
M25x1,5	5	34	38	4
M30x1,5	6	41	45	4
M35x1,5	7	48	52	4
M40x1,5	8	53	58	4
M45x1,5	9	60	65	4
M50x1,5	10	65	70	4
M55x2	11	69	75	4
M60x2	12	74	80	4
M65x2	13	79	85	4
M70x2	14	86	92	4

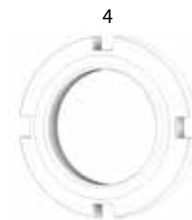
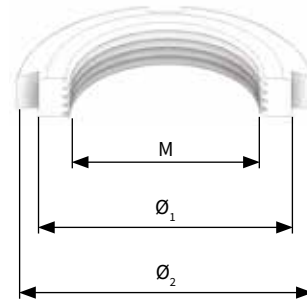

FOCUS ON



Ghiere filettate (DIN 981 - KM), interamente in acciaio.
 Threaded ring nuts (DIN 981 - KM), entirely in steel.



3 BUSSOLE E ACCESSORI

SOCKETS AND ACCESSORIES

64106

BUSSOLE DENTI INTERNI PER GHIERE KM

BUSSOLE PER GHIERE FILETTATE, DENTI INTERNI

SOCKETS FOR THREADED NUTS, INTERNAL TEETH

40/44 HRC

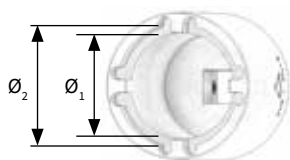



EASYPACK | sacchetto PVC con Euro-hole - PVC bags with Euro-hole

		Ø ₁ mm	Ø ₂ mm	PCS.	COD.	€ cad./each
3/8"	0	15,5	18,5	1	64106005	62,496
3/8"	1	19	22,5	1	64106010	62,496
1/2"	2	22	25,5	1	64106015	74,928
1/2"	3	25	29	1	64106020	81,200
1/2"	4	29	33	1	64106025	87,472
1/2"	5	35	39	1	64106030	93,632
1/2"	6	42	46	1	64106035	99,904
1/2"	7	49	53	1	64106040	112,336
1/2"	8	54	59	1	64106045	118,720
3/4"	9	61	66	1	64106050	131,152
3/4"	10	66	71	1	64106055	137,312
3/4"	11	70	76	1	64106060	152,992
3/4"	12	75	81	1	64106065	162,288
3/4"	13	80	86	1	64106070	209,104



DIMENSIONI BUSSOLE | sockets dimensions

M		S	H	P	
M10x0,75	0	2,5	5	65	4
M12x1	1	2,5	5	65	4
M15x1	2	3,5	6	65	4
M17x1	3	3,5	6	65	4
M20x1	4	3,5	7	60	4
M25x1,5	5	4,5	8	60	4
M30x1,5	6	4,5	8	60	4
M35x1,5	7	4,5	9	45	4
M40x1,5	8	5,5	10	45	4
M45x1,5	9	5,5	11	35	4
M50x1,5	10	5,5	12	35	4
M55x2	11	6,5	12	35	4
M60x2	12	6,5	12	35	4
M65x2	13	6,5	13	35	4
M70x2	14	7,0	13	35	4

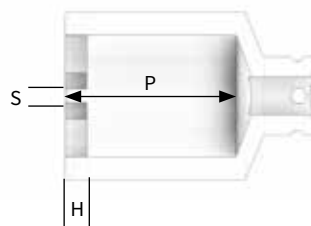
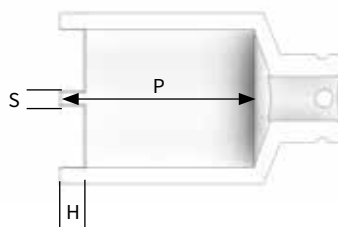

**64107**

ASSORTIMENTI BUSSOLE PER GHIERE KM

ASSORTIMENTI 11 PCS. BUSSOLE PER GHIERE
KIT WITH 11 SOCKETS FOR NUTS

250 X 120 X 180 mm

11
pcs.COD. **64107005**

€ 701,904



0	1	2	3	4	5	6	7	8	9	10
1pc.	1pc.	1pc.	1pc.	1pc.	1pc.	1pc.	1pc.	1pc.	1pc.	1pc.

COD. **64107010**

€ 1.102,304



0	1	2	3	4	5	6	7	8	9	10
1pc.	1pc.	1pc.	1pc.	1pc.	1pc.	1pc.	1pc.	1pc.	1pc.	1pc.

64108

ESPOSITORE BUSSOLE PER GHIERE KM

ESPOSITORE 11 PCS. BUSSOLE PER GHIERE
DISPLAY WITH 11 SOCKETS FOR NUTS

240 X 150 X 205 mm

11
pcs.COD. **64108005**

€ 802,368



0	1	2	3	4	5	6	7	8	9	10
1pc.	1pc.	1pc.	1pc.	1pc.	1pc.	1pc.	1pc.	1pc.	1pc.	1pc.

COD. **64108010**

€ 1.202,768

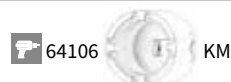

0	1	2	3	4	5	6	7	8	9	10
1pc.	1pc.	1pc.	1pc.	1pc.	1pc.	1pc.	1pc.	1pc.	1pc.	1pc.



3 BUSSOLE E ACCESSORI

SOCKETS AND ACCESSORIES

64061

IMPACT 3/4"

BUSSOLE IMPACT 3/4" CAVA ESAGONALE
3/4" IMPACT SOCKETS 6POINTS HEXAGON RECESS

40/44 HRC

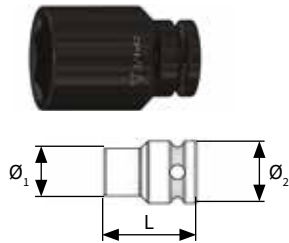

EASYPACK | sacchetto PVC con Euro-hole - PVC bags with Euro-hole

	L mm	Ø ₁ mm	Ø ₂ mm	PCS.	COD.	€ cad./each
15	45	29	44	1	64061025	19,327
16	45	29	44	1	64061035	19,327
17	50	30	44	1	64061040	17,069
18	52	31,3	44	1	64061050	17,069
19	52	32,5	44	1	64061055	17,181
20	52	33,8	44	1	64061060	17,311
21	52	35	44	1	64061070	17,311
22	52	36,3	44	1	64061075	17,311
23	52	37,5	44	1	64061085	17,311
24	52	38,8	44	1	64061095	17,311
25	52	40	44	1	64061100	17,926
26	52	41,3	44	1	64061110	17,926
27	52	42,5	44	1	64061115	18,418
28	52	43,5	44	1	64061120	18,418
29	52	45	44	1	64061130	18,418
30	52	46	44	1	64061135	18,418
31	52	49	44	1	64061140	20,266
32	52	48,8	44	1	64061150	20,266
33	56	50	44	1	64061155	24,270
34	56	51,3	44	1	64061165	25,010
35	56	52,5	44	1	64061170	25,010
36	56	53,8	44	1	64061175	25,010
37	55	55	44	1	64061185	26,118
38	56	56,3	44	1	64061190	26,118
39	58	57,5	44	1	64061195	29,383
40	58	58,5	44	1	64061205	30,246
41	58	60	44	1	64061210	30,246
42	58	61,3	44	1	64061215	31,847
43	62	62,5	44	1	64061220	31,847
44	62	63,8	44	1	64061225	34,496
45	63	65	44	1	64061235	35,448
46	63	66,3	44	1	64061240	36,652
47	68	67,5	54	1	64061245	38,993
48	68	68,8	54	1	64061255	44,475
49	70	70	54	1	64061260	44,475
50	72	71,3	54	1	64061265	44,475
51	70	73	54	1	64061270	47,309
52	72	73,8	54	1	64061275	47,309
54	72	76,3	54	1	64061285	54,824
55	74	77,5	54	1	64061290	54,270
56	74	78,8	54	1	64061300	58,458
57	75	82	54	1	64061305	58,766
58	75	82	54	1	64061310	59,875
59	75	82	54	1	64061315	59,875
60	80	83,8	54	1	64061320	61,723
61	75	86	54	1	64061330	70,162



p. 318

64061

ASSORTIMENTI BUSSOLE 3/4" IMPACT

SERIE 9 PCS. BUSSOLE 3/4" IMPACT IN CASSETTA METALLICA

9 PCS. 3/4" IMPACT SOCKETS SET WITH METAL CASE



9
pcs.

COD. **64061401**

€ 190,800

64061 

19	22	24	27	30	32	36	41	46
1pc.	1pc.	1pc.	1pc.	1pc.	1pc.	1pc.	1pc.	1pc.



3 BUSSOLE E ACCESSORI

SOCKETS AND ACCESSORIES

64063

IMPACT 3/4" SERIE LUNGA

BUSSOLE IMPACT 3/4" CAVA ESAGONALE - TIPO LUNGO

3/4" IMPACT SOCKETS 6POINTS HEXAGON RECESS - LONG SERIES

40/44 HRC

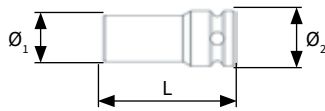

EASYPACK | sacchetto PVC con Euro-hole - PVC bags with Euro-hole

	L mm	Ø ₁ mm	Ø ₂ mm	PCS.	COD.	€ cad./each
17	90	30	44	1	64063040	24,360
19	90	32	44	1	64063055	24,360
21	90	35	44	1	64063070	24,360
22	90	36,5	44	1	64063075	24,360
23	90	38	44	1	64063085	24,864
24	90	39	44	1	64063095	24,864
25	90	40	44	1	64063100	24,864
26	90	41	44	1	64063110	24,864
27	90	42,5	44	1	64063115	24,864
28	90	43,5	44	1	64063120	29,176
29	90	45	44	1	64063130	29,176
30	90	46	44	1	64063135	29,176
31	90	49	44	1	64063140	30,072
32	90	49	44	1	64063150	30,072
33	90	50	44	1	64063155	38,584
34	90	52	44	1	64063165	38,584
35	90	52	44	1	64063170	38,584
36	90	54	44	1	64063175	38,584
37	90	54	44	1	64063185	41,384
38	92	56,5	44	1	64063190	41,384
39	90	57	44	1	64063195	44,184
40	92	59	44	1	64063205	44,184
41	92	60	44	1	64063210	45,640
43	92	62,5	44	1	64063220	45,640
44	92	64	44	1	64063225	57,120
45	92	65	44	1	64063235	57,120
46	92	66,5	44	1	64063240	57,120
47	90	67	54	1	64063245	57,120
48	92	69	54	1	64063255	65,184
49	90	70	54	1	64063260	65,184
50	95	71,5	54	1	64063265	65,184
51	90	73	54	1	64063270	65,184
54	95	73	54	1	64063285	80,360
55	100	78	54	1	64063290	83,720
56	100	78	54	1	64063300	85,680
57	100	82	54	1	64063305	86,128
58	100	82	54	1	64063310	87,696
59	100	82	54	1	64063315	87,696
60	105	84	54	1	64063320	94,976
61	100	86	54	1	64063330	119,616



64139

IMPACT 3/4" INTEGRALE ESAGONO MASCHIO

BUSSOLE IMPACT 3/4" ESAGONO MASCHIO INTEGRALI

3/4" IMPACT SOCKETS ONE-PIECE MALE HEXAGON

40/44 HRC

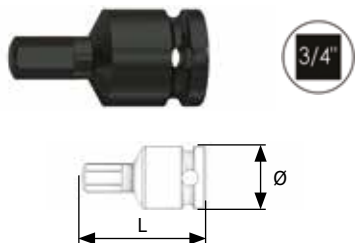

EASYPACK | sacchetto PVC con Euro-hole - PVC bags with Euro-hole

Ø	L mm	Ø mm	PCS.	COD.	€ cad./each
10	60	38	1	64139005	22,848
11	60	38	1	64139010	22,848
12	60	38	1	64139015	22,848
14	60	38	1	64139025	25,088
15	60	38	1	64139030	25,088
16	60	38	1	64139035	25,088
17	60	38	1	64139040	25,088
18	60	38	1	64139045	25,088
20	65	44	1	64139055	30,016
21	65	44	1	64139060	30,016
23	65	44	1	64139070	30,016
24	65	44	1	64139075	30,016

62205

PROLUNGHE

PROLUNGA IMPACT PER BUSSOLE 3/4"

IMPACT EXTENSION FOR 3/4" SOCKETS

40/44 HRC

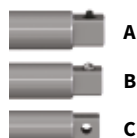

EASYPACK | sacchetto PVC con Euro-hole - PVC bags with Euro-hole

L mm	A/B/C	Ø mm	PCS.	COD.	€ cad./each
75	C	44	1	62205005	69,888
175	C	44	1	62205020	32,426
250	C	44	1	62205025	38,248
325	C	44	1	62205030	49,990

62207

PROLUNGHE SNODATE

PROLUNGA IMPACT SNODATA PER BUSSOLE 3/4"

IMPACT UNIVERSAL JOINT FOR 3/4" SOCKETS

40/44 HRC

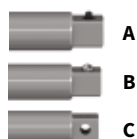
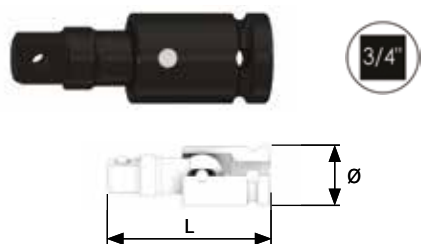

EASYPACK | sacchetto PVC con Euro-hole - PVC bags with Euro-hole

L mm	A/B/C	Ø mm	PCS.	COD.	€ cad./each
90	C	44	1	62207005	62,832



3 BUSSOLE E ACCESSORI

SOCKETS AND ACCESSORIES

62206

PROLUNGHE SGANCIO RAPIDO

PROLUNGA IMPACT PER BUSSOLE 3/4" - CON SGANCIO RAPIDO
IMPACT EXTENSION FOR 3/4" SOCKETS - WITH QUICK RELEASE

40/44 HRC

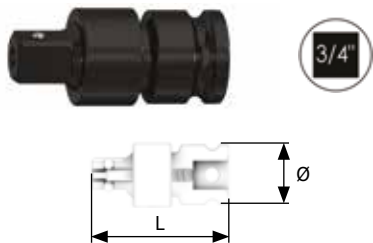
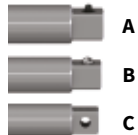

EASYPACK | sacchetto PVC con Euro-hole - PVC bags with Euro-hole

L mm	A/B/C	Ø mm	PCS.	COD.	€ cad./each
80	B	44	1	62206005	205,520



62126

RIDUZIONI

RIDUZIONE IMPACT 3/4" PER BUSSOLE DA 1/2"
3/4" IMPACT REDUCTION FOR 1/2" SOCKETS

40/44 HRC

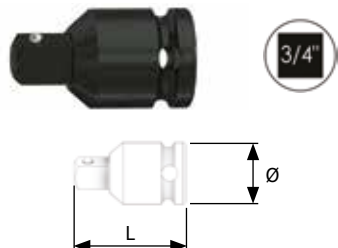
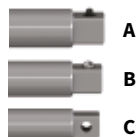

EASYPACK | sacchetto PVC con Euro-hole - PVC bags with Euro-hole

L mm	A/B/C	Ø mm	PCS.	COD.	€ cad./each
56	C	44	1	62126005	25,800
56	B	44	1	62126010	25,800
175	B	44	1	62126015	68,992



62141

ADATTATORI/AUMENTATORI

ADATTATORE/AUMENTATORE IMPACT 3/4" PER BUSSOLE DA 1"
3/4" IMPACT ADAPTER/INCREASER FOR 1" SOCKETS

40/44 HRC

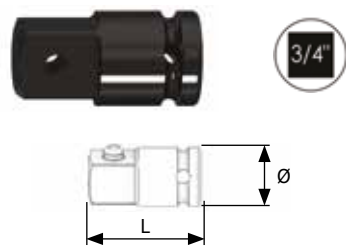
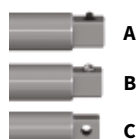

EASYPACK | sacchetto PVC con Euro-hole - PVC bags with Euro-hole

L mm	A/B/C	Ø mm	PCS.	COD.	€ cad./each
63	C	44	1	62141005	31,902





3

Vista di impianti di pompe industriali.
An industrial pump.



3 BUSSOLE E ACCESSORI

SOCKETS AND ACCESSORIES

64071

IMPACT 1"

BUSSOLE IMPACT 1" CAVA ESAGONALE
1" IMPACT SOCKETS 6POINTS HEXAGON RECESS

40/44 HRC

EASYPACK | sacchetto PVC con Euro-hole - PVC bags with Euro-hole

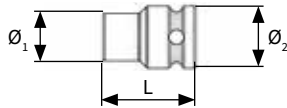

●	L mm	Ø ₁ mm	Ø ₂ mm	PCS.	COD.	€ cad./each
19	58	36,5	54	1	64071005	48,012
20	58	38	54	1	64071010	48,012
21	60	39	54	1	64071015	48,012
22	60	40	54	1	64071020	48,012
23	60	41,5	54	1	64071025	48,012
24	60	42,5	54	1	64071030	51,557
25	60	44	54	1	64071035	51,557
26	60	45	54	1	64071040	51,557
27	60	46,5	54	1	64071045	51,557
28	60	47,5	54	1	64071050	51,557
29	60	49	54	1	64071055	51,557
30	62	50	54	1	64071060	51,557
31	63	51	54	1	64071065	51,555
32	63	52,5	54	1	64071070	51,557
33	63	54	54	1	64071075	51,557
34	63	55	54	1	64071080	53,329
35	63	56,5	54	1	64071085	53,329
36	67	57,5	54	1	64071090	55,101
37	67	59	54	1	64071095	56,873
38	67	60	54	1	64071100	58,645
39	67	60	54	1	64071105	58,682
41	70	64	54	1	64071115	65,733
42	70	65	54	1	64071120	67,505
46	76	70	54	1	64071140	67,505
47	76	71,5	54	1	64071145	76,365
48	70	73	54	1	64071150	78,329

●	L mm	Ø ₁ mm	Ø ₂ mm	PCS.	COD.	€ cad./each
49	70	73	54	1	64071155	79,959
50	82	75	54	1	64071160	84,802
51	70	73	54	1	64071165	85,626
52	82	77,5	54	1	64071170	90,778
54	82	80	54	1	64071175	90,778
55	87	81,5	54	1	64071180	95,312
56	87	82,5	54	1	64071185	104,380
57	87	82	54	1	64071190	111,798
58	87	85	54	1	64071195	112,623
59	80	86	54	1	64071200	112,623
60	91	87,5	54	1	64071205	118,084
61	85	88	54	1	64071210	134,776
62	85	92	54	1	64071215	129,418
65	94	94	54	1	64071220	129,418
70	100	100	86	1	64071230	136,219
75	104	106,5	86	1	64071240	179,290
76	100	105	86	1	64071245	229,264
77	100	105	86	1	64071250	266,152
80	108	112,5	86	1	64071255	229,264
85	110	119	86	1	64071260	295,004
86	105	115	86	1	64071265	339,414
90	112	125	86	1	64071270	347,348
95	115	129	86	1	64071275	399,177
100	115	134	86	1	64071280	440,187
105	120	142	127	1	64071285	486,452
110	125	147	127	1	64071290	571,151
115	125	153	127	1	64071295	656,365



**64072****IMPACT 1" SERIE LUNGA****BUSSOLE IMPACT 1" CAVA ESAGONALE - TIPO LUNGO**

1" IMPACT SOCKETS 6POINTS HEXAGON RECESS - LONG SERIES

40/44 HRC

EASYPACK | sacchetto PVC con Euro-hole - PVC bags with Euro-hole

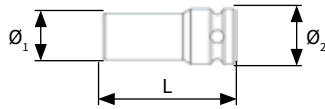

	L mm	Ø ₁ mm	Ø ₂ mm	PCS.	COD.	€ cad./each
19	110	36,5	54	1	64072005	74,294
20	110	38	54	1	64072010	74,294
21	110	39	54	1	64072015	74,294
22	110	40	54	1	64072020	74,294
23	110	41,5	54	1	64072025	74,294
24	110	42,5	54	1	64072030	74,294
25	110	44	54	1	64072035	74,294
26	110	45	54	1	64072040	74,294
27	110	46,5	54	1	64072045	74,294
28	110	47,5	54	1	64072050	74,294
29	110	49	54	1	64072055	74,294
30	110	50	54	1	64072060	74,294
32	110	52,5	54	1	64072070	74,294
33	110	54	54	1	64072075	74,294
34	110	55	54	1	64072080	79,349
35	110	56,5	54	1	64072085	79,349
36	110	57,5	54	1	64072090	81,034
37	110	59	54	1	64072095	82,719
38	110	60	54	1	64072100	94,513
41	110	64	54	1	64072115	94,513
42	110	65	54	1	64072120	99,567
46	110	70	54	1	64072140	102,937
47	110	71,5	54	1	64072145	121,471

	L mm	Ø ₁ mm	Ø ₂ mm	PCS.	COD.	€ cad./each
50	115	75	54	1	64072160	128,210
51	115	73	54	1	64072165	113,804
52	115	77,5	54	1	64072170	129,895
54	115	80	54	1	64072175	134,950
55	115	81,5	54	1	64072180	146,744
56	115	82,5	54	1	64072185	151,799
58	115	85	54	1	64072195	155,168
59	105	86	54	1	64072200	153,586
60	120	87,5	54	1	64072205	155,168
65	125	94	54	1	64072220	183,811
70	130	100	86	1	64072230	214,139
75	135	106,5	86	1	64072240	273,110
80	140	112,5	86	1	64072255	293,329
85	140	119	86	1	64072260	311,862
90	143	125	86	1	64072270	404,531
95	145	129	86	1	64072275	530,897
100	145	134	86	1	64072280	584,813





3 BUSSOLE E ACCESSORI

SOCKETS AND ACCESSORIES

62211

PROLUNGHE

PROLUNGA IMPACT PER BUSSOLE 1"
IMPACT EXTENSION FOR 1" SOCKETS

40/44 HRC

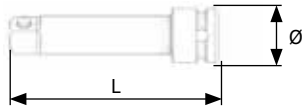
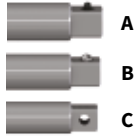

EASYPACK | sacchetto PVC con Euro-hole - PVC bags with Euro-hole

L mm	A/B/C	Ø mm	PCS.	COD.	€ cad./each
100	C	54	1	62211005	93,363
175	C	54	1	62211015	98,706
250	C	54	1	62211020	109,200
330	C	54	1	62211025	128,710



62212

PROLUNGHE SNODATE

PROLUNGA IMPACT SNODATE PER BUSSOLE 1"
IMPACT UNIVERSAL JOINT FOR 1" SOCKETS

40/44 HRC

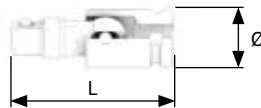
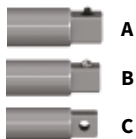

EASYPACK | sacchetto PVC con Euro-hole - PVC bags with Euro-hole

L mm	A/B/C	Ø mm	PCS.	COD.	€ cad./each
110	C	54	1	62212005	223,216



**62137**

RIDUZIONI

RIDUZIONE IMPACT 1" PER BUSSOLE DA 3/4"

1" IMPACT REDUCTION FOR 3/4" SOCKETS

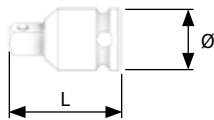
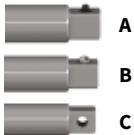
40/44 HRC**EASYPACK** | sacchetto PVC con Euro-hole - PVC bags with Euro-hole

L mm	A/B/C	Ø mm	PCS.	COD.	€ cad./each
75	C	54	1	62137005	47,502

**62145**

ADATTATORI/AUMENTATORI

ADATTATORE/AUMENTATORE IMPACT 1" PER BUSSOLE DA 1-1/2"

1" IMPACT ADAPTER/INCREASER FOR 1-1/2" SOCKETS

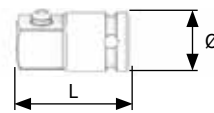
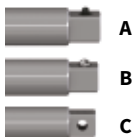
40/44 HRC**EASYPACK** | sacchetto PVC con Euro-hole - PVC bags with Euro-hole

L mm	A/B/C	Ø mm	PCS.	COD.	€ cad./each
85	C	54	1	62145005	107,094

**3**



3 BUSSOLE E ACCESSORI

SOCKETS AND ACCESSORIES

64081

IMPACT 1-1/2"

BUSSOLE IMPACT 1-1/2" CAVA ESAGONALE
1-1/2" IMPACT SOCKETS 6POINTS HEXAGON RECESS

40/44 HRC

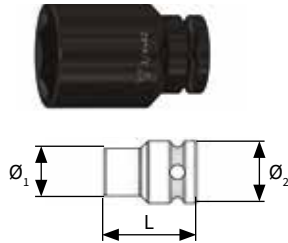

EASYPACK | sacchetto PVC con Euro-hole - PVC bags with Euro-hole

	L mm	Ø ₁ mm	Ø ₂ mm	PCS.	COD.	€ cad./each
32	75	60	86	1	64081005	117,993
33	75	60	86	1	64081010	117,993
34	75	60	86	1	64081015	117,993
35	75	60	86	1	64081020	117,993
36	80	64	86	1	64081025	126,867
37	80	64	86	1	64081030	126,867
38	80	64	86	1	64081035	126,867
39	80	70	86	1	64081040	126,867
40	80	70	86	1	64081045	126,867
41	80	70	86	1	64081050	126,867
42	80	70	86	1	64081055	126,867
43	80	75	86	1	64081060	126,867
44	80	75	86	1	64081065	126,867
45	80	75	86	1	64081070	126,867
46	80	75	86	1	64081075	126,867
47	80	75	86	1	64081080	126,867
48	80	80	86	1	64081085	129,545
49	80	80	86	1	64081090	129,545
50	80	80	86	1	64081095	129,545
51	80	80	86	1	64081100	129,545
52	90	80	86	1	64081105	129,545
54	90	86	86	1	64081110	129,545
55	90	86	86	1	64081115	129,545
56	90	86	86	1	64081120	144,558
57	90	86	86	1	64081125	144,558
58	90	92	86	1	64081130	144,558
59	90	92	86	1	64081135	144,558
60	90	92	86	1	64081140	159,247
61	95	96	86	1	64081145	159,247
62	95	96	86	1	64081150	159,247
65	95	100	86	1	64081155	177,378
67	100	100	86	1	64081160	184,301
70	100	105	86	1	64081165	238,791
73	105	109	86	1	64081170	278,763
75	105	109	86	1	64081175	288,900
76	110	115	86	1	64081180	308,618
77	110	115	86	1	64081185	338,416
80	110	115	86	1	64081190	338,416
85	115	121	86	1	64081195	358,116
86	115	127	86	1	64081200	378,446
90	120	130	86	1	64081205	390,534
95	120	135	127	1	64081210	596,747
100	125	140	127	1	64081215	668,334
105	125	150	127	1	64081220	757,862
110	135	155	127	1	64081225	823,482
115	135	160	127	1	64081230	823,482
120	145	165	127	1	64081235	907,023
125	145	170	127	1	64081240	916,834
130	160	180	127	1	64081245	966,083



**62215**

PROLUNGHE

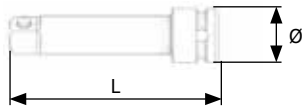
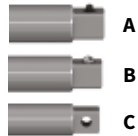
PROLUNGA IMPACT PER BUSSOLE 1-1/2"
IMPACT EXTENSION FOR 1-1/2" SOCKETS**40/44 HRC**

EASYPACK | sacchetto PVC con Euro-hole - PVC bags with Euro-hole

L mm	A/B/C	Ø mm	PCS.	COD.	€ cad./each
150	C	84	1	62215005	376,824
250	C	84	1	62215010	404,230
380	C	84	1	62215015	577,685
455	C	84	1	62215020	654,696

**62216**

PROLUNGHE SNODATE

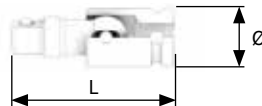
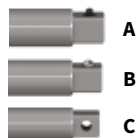
PROLUNGA IMPACT SNODATA PER BUSSOLE 1-1/2"
IMPACT UNIVERSAL JOINT FOR 1-1/2" SOCKETS**40/44 HRC**

EASYPACK | sacchetto PVC con Euro-hole - PVC bags with Euro-hole

L mm	A/B/C	Ø mm	PCS.	COD.	€ cad./each
168	C	86	1	62216005	623,650

**62142**

RIDUZIONI

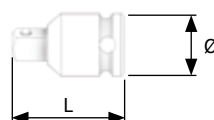
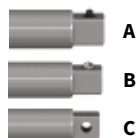
RIDUZIONE 3/4" PER BUSSOLE DA 1/2"
3/4" REDUCTION FOR 1/2" SOCKETS**40/44 HRC**

EASYPACK | sacchetto PVC con Euro-hole - PVC bags with Euro-hole

L mm	A/B/C	Ø mm	PCS.	COD.	€ cad./each
95	C	86	1	62142005	183,310





3 BUSSOLE E ACCESSORI

SOCKETS AND ACCESSORIES

64999

O-RING ANELLO FERMO

ANELLO FERMO PER SPINA DI BLOCCAGGIO

IMPACT SOCKET RETAINING RING

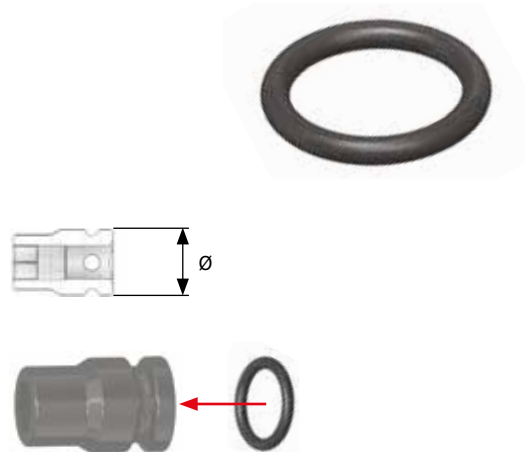

EASYPACK | sacchetto PVC con Euro-hole - PVC bags with Euro-hole

	Ø mm	PCS.	COD.	€ cad./each	
	1/4"	13	5	64999001	0,235
	3/8"	19	5	64999002	0,302
	3/8"	22	5	64999003	0,336
	1/2"	25	5	64999004	0,482
	1/2"	30	5	64999005	0,605
	1/2"	35-38	5	64999006	0,784
	3/4"	44	5	64999007	0,963
	3/4" - 1"	54	5	64999008	1,120
	1" - 1/2"	86	5	64999009	2,072
	1" - 1/2"	127	5	64999010	4,290

64999

SPINA DI BLOCCAGGIO

SPINA DI BLOCCAGGIO PER BUSSOLE IMPACT

IMPACT SOCKET RETAINING PIN

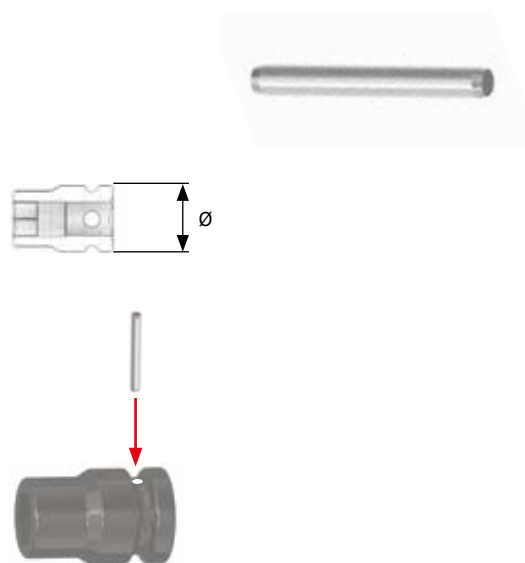

EASYPACK | sacchetto PVC con Euro-hole - PVC bags with Euro-hole

	Ø mm	PCS.	COD.	€ cad./each	
	1/4"	13	5	64999021	0,840
	3/8"	19	5	64999022	0,840
	3/8"	22	5	64999023	0,840
	1/2"	25	5	64999024	0,840
	1/2"	30	5	64999025	0,840
	1/2"	35-38	5	64999026	0,907
	3/4"	44	5	64999027	1,400
	3/4" - 1"	54	5	64999028	1,960
	1" - 1/2"	86	5	64999029	2,901
	1" - 1/2"	127	5	64999030	3,002



3

Vista di un impianto di estrazione petrolifero in alto mare
Offshore oil drilling platform.

CHROME

BUSSOLE E ACCESSORI CHROME *CHROME sockets and accessories*



Realizzate in acciaio al Cromo Vanadio di alta qualità. Collare godronato per una miglior presa e resistente rivestimento superficiale di cromatura.

Made in high quality Chrome-Vanadium steel. Knurled collar for better grip and resistant chrome-plated surface coating.



Impronta esagonale tipo SUPER- LOCK: il contatto con il dado non avviene sullo spigolo ma sulla faccia dell'esagono, che offre una maggior superficie di appoggio.

SUPER-LOCK hex tip: the contact with the nut does not take place on the edge, but on the face of the hexagon, which offers a larger support surface.



Indicate per applicazioni manuali in ambito professionale.

Suitable for professional manual applications.



64008 SUPERLOCK 1/4"

BUSSOLE 1/4" CAVA ESAGONALE TIPO SUPER-LOCK
1/4" SOCKETS SUPER-LOCK HEXAGON RECESS

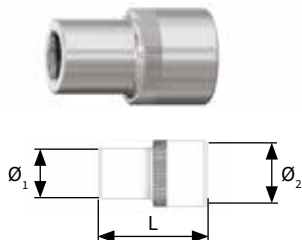

EASYPACK | sacchetto PVC con Euro-hole - PVC bags with Euro-hole

●	L mm	Ø ₁ mm	Ø ₂ mm	PCS.	COD.	€ cad./each
4	25	7	12	1	64008005	2,178
4,5	25	7,2	12	1	64008010	2,178
5	25	8	12	1	64008015	2,178
5,5	25	8,7	12	1	64008020	2,178
6	25	9,3	12	1	64008025	2,178
7	25	10,5	12	1	64008030	2,178
8	25	12	12	1	64008035	2,178
9	25	13	12	1	64008040	2,212
10	25	14	12	1	64008045	2,245
11	25	16	14	1	64008050	2,387
12	25	17	15	1	64008055	2,521
13	25	18	16	1	64008060	2,696
14	25	20	18	1	64008065	2,838

●	L mm	COD.	€ box
4	25	64008005001	2,828
4,5	25	64008010001	2,828
5	25	64008015001	2,828
5,5	25	64008020001	2,828
6	25	64008025001	2,828
7	25	64008030001	2,828
8	25	64008035001	2,828
9	25	64008040001	2,862
10	25	64008045001	2,895
11	25	64008050001	3,037
12	25	64008055001	3,171
13	25	64008060001	3,346
14	25	64008065001	3,488



SELFPACK
1 pc.

64008 ASSORTIMENTI BUSSOLE 1/4" SUPERLOCK

SERIE 10 PCS. BUSSOLE 1/4" SUPERLOCK
10 PCS. SET 1/4" SOCKETS SOPERLOCK

10
pcs.

COD. **64008201**
€ 20,849

64008



200 X 35 X 18 mm

5 1pc.	5,5 1pc.	6 1pc.	7 1pc.	8 1pc.	9 1pc.	10 1pc.	11 1pc.	12 1pc.	13 1pc.
-----------	-------------	-----------	-----------	-----------	-----------	------------	------------	------------	------------



3 BUSSOLE E ACCESSORI SOCKETS AND ACCESSORIES

64009 ESAGONALE 1/4"

BUSSOLE 1/4" CAVA ESAGONALE
1/4" SOCKETS 6POINTS HEXAGON RECESS

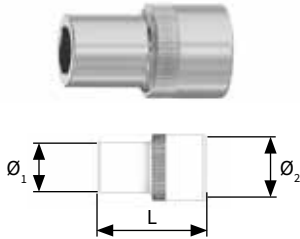

EASYPACK | sacchetto PVC con Euro-hole - PVC bags with Euro-hole

Ø	L mm	Ø ₁ mm	Ø ₂ mm	PCS.	COD.	€ cad./each
4	25	6,8	12	1	64009006	2,178
4,5	25	7,1	12	1	64009010	2,178
5	25	7,8	12	1	64009015	2,178
5,5	25	8,3	12	1	64009020	2,178
6	25	9,1	12	1	64009025	2,178
7	25	10,3	12	1	64009030	2,178
8	25	11,5	12	1	64009035	2,178
9	25	13	12	1	64009040	2,212
10	25	14	12	1	64009045	2,245
11	25	16	13	1	64009050	2,387
12	25	17	14	1	64009055	2,521
13	25	18	15	1	64009060	2,696
14	25	20	16	1	64009065	2,838

Ø	L mm	COD.	€ box
4	25	64009006001	2,828
4,5	25	64009010001	2,828
5	25	64009015001	2,828
5,5	25	64009020001	2,828
6	25	64009025001	2,828
7	25	64009030001	2,828
8	25	64009035001	2,828
9	25	64009040001	2,862
10	25	64009045001	2,895
11	25	64009050001	3,037
12	25	64009055001	3,171
13	25	64009060001	3,346
14	25	64009065001	3,488



SELPACK
1 pc.

64009 ASSORTIMENTI BUSSOLE 1/4" ESAGONALI

SERIE 13 PCS. BUSSOLE 1/4" ESAGONALI
13 PCS. SET 1/4" SOCKETS 6POINTS HEXAGONAL

13
pcs.

COD. **64009201**
€ 27,150



200 X 35 X 18 mm

64009

4	4,5	5	5,5	6	7	8	9	10	11	12	13	14
1pc.	1pc.	1pc.	1pc.	1pc.	1pc.	1pc.	1pc.	1pc.	1pc.	1pc.	1pc.	1pc.

**64010**

ESAGONALE 1/4" LUNGHE

BUSSOLE 1/4" CAVA ESAGONALE TIPO LUNGO**1/4" SOCKETS 6POINTS HEXAGON RECESS LONG SERIES**

EASYPACK | sacchetto PVC con Euro-hole - PVC bags with Euro-hole

Ø	L mm	Ø ₁ mm	Ø ₂ mm	PCS.	COD.	€ cad./each
4	50	6,8	12	1	64010005	3,392
4,5	50	7,1	12	1	64010010	3,392
5	50	7,8	12	1	64010015	3,392
5,5	50	8,3	12	1	64010020	3,392
6	50	9,1	12	1	64010025	3,392
7	50	10,3	12	1	64010030	3,392
8	50	11,5	12	1	64010035	3,392
9	50	13	12	1	64010040	3,459
10	50	14	12	1	64010045	3,560
11	50	16	13	1	64010050	3,983
12	50	17	14	1	64010055	4,117
13	50	18	15	1	64010060	4,329
14	50	20	16	1	64010065	5,029

64010

ASSORTIMENTI BUSSOLE 1/4" ESAGONALI LUNGHE

SERIE 13 PCS. BUSSOLE 1/4" ESAGONALI TIPO LUNGO**13 PCS. SET 1/4" SOCKETS 6POINTS HEXAGONAL LONG SERIES**

200 X 35 X 18 mm

13
pcs.COD. **64010201****€ 43,400**

64010

4	4,5	5	5,5	6	7	8	9	10	11	12	13	14
1pc.	1pc.	1pc.	1pc.	1pc.	1pc.	1pc.	1pc.	1pc.	1pc.	1pc.	1pc.	1pc.



3 BUSSOLE E ACCESSORI

SOCKETS AND ACCESSORIES

64127

CAVA TX(E) 1/4"

BUSSOLE 1/4" CAVA PER VITI TORX(E)

1/4" SOCKETS RECESS FOR TORX(E) BOLTS AND NUTS

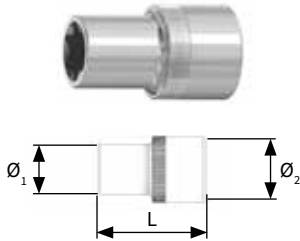

EASYPACK | sacchetto PVC con Euro-hole - PVC bags with Euro-hole

	L mm	Ø ₁ mm	Ø ₂ mm	PCS.	COD.	€ cad./each
E4	25	5,4	12	1	64127005	2,941
E5	25	6,7	12	1	64127010	2,941
E6	25	7,7	12	1	64127015	2,941
E7	25	8,3	12	1	64127020	2,941
E8	25	9,6	12	1	64127025	2,941
E10	25	11,3	13,7	1	64127030	3,340

64127

ASSORTIMENTI BUSSOLE 1/4" CAVA TX(E)

SERIE 6 PCS. BUSSOLE 1/4" CAVA PER VITI TX(E)

6 PCS. SET 1/4" SOCKETS FOR TORX(E) BOLTS AND NUTS



200 X 35 X 18 mm

6
pcs.

COD. **64127201**

€ 17,200

64127

E4 1pc.	E5 1pc.	E6 1pc.	E7 1pc.	E8 1pc.	E10 1pc.
------------	------------	------------	------------	------------	-------------

**64149**

BUSSOLE CON INSERTO TAGLIO

BUSSOLE 1/4" CON INSERTO A TAGLIO

1/4" SOCKETS WITH SLOTTED BIT

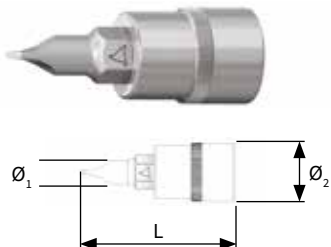

EASYPACK | sacchetto PVC con Euro-hole - PVC bags with Euro-hole

	Ø ₁ mm	L mm	Ø ₂ mm	PCS.	COD.	€ cad./each	
	0,6	4,0	32	12	1	64149005	2,742
	0,8	5,5	32	12	1	64149010	2,742
	1,2	7,0	32	12	1	64149015	2,742



SELFPACK
1 pc.

	L mm	COD.	€ box	
	0,6	32	64149005001	3,392
	0,8	32	64149010001	3,392
	1,2	32	64149015001	3,392

64150

BUSSOLE CON INSERTO PH

BUSSOLE 1/4" CON INSERTO PHILLIPS®

1/4" SOCKETS WITH PHILLIPS® BIT

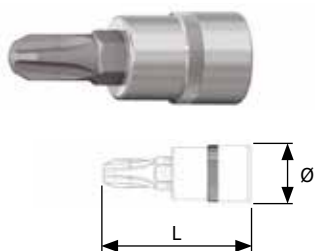

EASYPACK | sacchetto PVC con Euro-hole - PVC bags with Euro-hole

	L mm	Ø mm	PCS.	COD.	€ cad./each	
	PH1	32	12	1	64150005	2,532
	PH2	32	12	1	64150010	2,532
	PH3	36	12	1	64150015	2,532



SELFPACK
1 pc.

	L mm	COD.	€ box	
	PH1	32	64150005001	3,182
	PH2	32	64150010001	3,182
	PH3	32	64150015001	3,182



3 BUSSOLE E ACCESSORI

SOCKETS AND ACCESSORIES

64151

BUSSOLE CON INSERTO PZ

BUSSOLE 1/4" CON INSERTO POZIDRIV®
1/4" SOCKETS WITH POZIDRIV® BIT

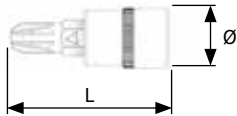

EASYPACK | sacchetto PVC con Euro-hole - PVC bags with Euro-hole

	L mm	Ø mm	PCS.	COD.	€ cad./each
PZ1	32	12	1	64151005	2,532
PZ2	32	12	1	64151010	2,532
PZ3	36	12	1	64151015	2,532



SELFPACK
1 pc.



	L mm	COD.	€ box
PZ1	32	64151005001	3,182
PZ2	32	64151010001	3,182
PZ3	32	64151015001	3,182

64147

BUSSOLE CON INSERTO TX

BUSSOLE 1/4" CON INSERTO PER VITI TORX®
1/4" SOCKETS WITH BIT FOR TORX® SCREWS

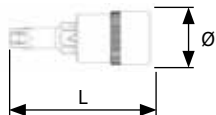

EASYPACK | sacchetto PVC con Euro-hole - PVC bags with Euro-hole

	L mm	Ø mm	PCS.	COD.	€ cad./each
TX10	32	12	1	64147005	2,742
TX15	32	12	1	64147010	2,742
TX20	32	12	1	64147015	2,742
TX25	32	12	1	64147020	2,742
TX27	32	12	1	64147025	2,742
TX30	32	12	1	64147030	2,742
TX40	32	12	1	64147035	2,742



SELFPACK
1 pc.



	L mm	COD.	€ box
TX10	32	64147005001	3,392
TX15	32	64147010001	3,392
TX20	32	64147015001	3,392
TX25	32	64147020001	3,392
TX27	32	64147025001	3,392
TX30	32	64147030001	3,392
TX40	32	64147035001	3,392



64145

BUSSOLE CON INSERTO ESAGONALE

BUSSOLE 1/4" CON INSERTO ESAGONALE
1/4" SOCKETS WITH HEXAGONAL BIT

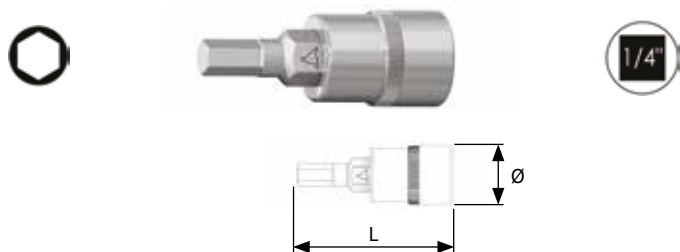

EASYPACK | sacchetto PVC con Euro-hole - PVC bags with Euro-hole

Ø	L mm	Ø mm	PCS.	COD.	€ cad./each
3	32	12	1	64145005	2,742
4	32	12	1	64145010	2,742
5	32	12	1	64145015	2,742
6	32	12	1	64145020	2,742
7	32	12	1	64145025	2,742
8	32	12	1	64145030	2,742

Ø	L mm	COD.	€ box
3	32	64145005001	3,392
4	32	64145010001	3,392
5	32	64145015001	3,392
6	32	64145020001	3,392
7	32	64145025001	3,392
8	32	64145030001	3,392



SELFPACK
1 pc.

64148

ASSORTIMENTI BUSSOLE 1/4" CON INSERTO

ASSORTIMENTI BUSSOLE 1/4" CON INSERTO
1/4" SOCKETS SETS WITH BIT



200 X 46 X 13 mm

7
pcs.

COD. **64148005**

€ 17,299

64147

TX10	TX15	TX20	TX25	TX27	TX30	TX40
1pc.	1pc.	1pc.	1pc.	1pc.	1pc.	1pc.



200 X 46 X 13 mm

6
pcs.

COD. **64148010**

€ 14,817

64145

3	4	5	6	7	8
1pc.	1pc.	1pc.	1pc.	1pc.	1pc.



3 BUSSOLE E ACCESSORI

SOCKETS AND ACCESSORIES

62173

PROLUNGHE

PROLUNGA PER BUSSOLE 1/4"
EXTENSION FOR 1/4" SOCKETS

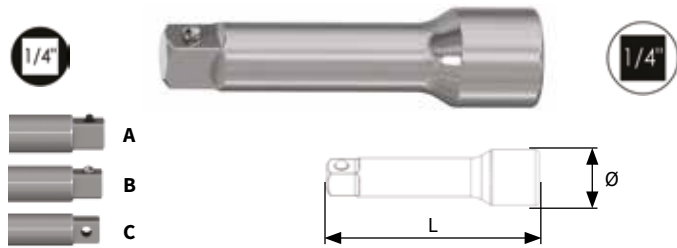

EASYPACK | sacchetto PVC con Euro-hole - PVC bags with Euro-hole

L mm	A/B/C	Ø mm	PCS.	COD.	€ cad./each
50	B	12	1	62173005	3,302
150	B	12	1	62173010	5,778



L mm	COD.	€ box
50	62173005001	3,917
150	62173010001	6,416

SELPACK
1 pc.

62173

PROLUNGHE SEMI-SNODO

PROLUNGA A DUE VIE - RETTILINEA + ANGOLARE PER BUSSOLE 1/4"
EXTENSION 2WAY - STRAIGHT + WOBBLE FOR 1/4" SOCKETS

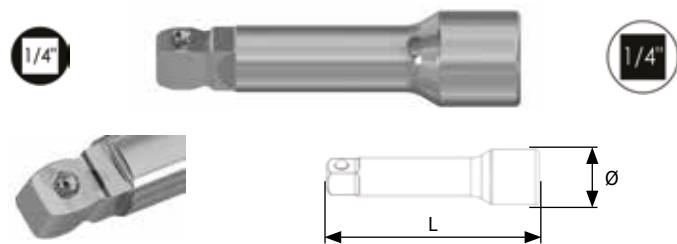

EASYPACK | sacchetto PVC con Euro-hole - PVC bags with Euro-hole

L mm	Ø mm	PCS.	COD.	€ cad./each
52	12,5	1	62173105	5,000
100	12,5	1	62173110	6,200

62174

PROLUNGHE SNODATE

PROLUNGA PER BUSSOLE 1/4" SNODATA
UNIVERSAL JOINT FOR 1/4" SOCKETS

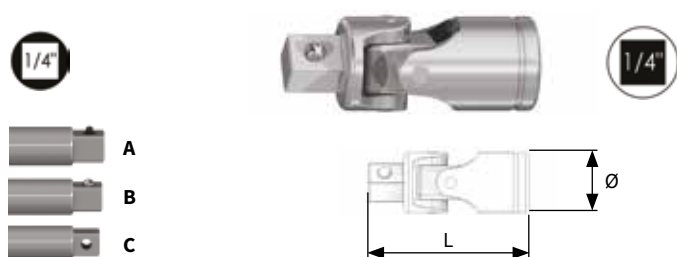

EASYPACK | sacchetto PVC con Euro-hole - PVC bags with Euro-hole

L mm	A/B/C	Ø mm	PCS.	COD.	€ cad./each
40	B	12	1	62174005	6,608



L mm	COD.	€ box
40	62174005001	7,288

SELPACK
1 pc.

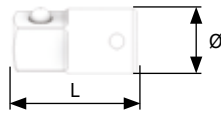
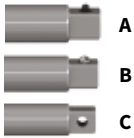
**62115****ADATTATORI/AUMENTATORI****ADATTATORE/AUMENTATORE 1/4" PER BUSSOLE DA 3/8"**
1/4" ADAPTER/ENHANCER FOR 3/8" SOCKETS

EASYPACK | sacchetto PVC con Euro-hole - PVC bags with Euro-hole

L mm	A/B/C	Ø mm	PCS.	COD.	€ cad./each
26	B	13	1	62115001	3,850

SELFPACK
1 pc.

L mm	COD.	€ box
26	62115001001	4,492

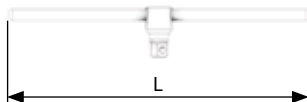
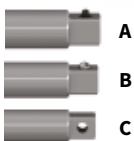
64220**BARRE A "T"****LEVA PER BUSSOLE CON ASTA MOBILE**
LEVER FOR SOCKETS WITH MOBILE ROD

L mm	A/B/C	PCS.	COD.	€ cad./each
115	B	1	64220005	4,952

SELFPACK
1 pc.

L mm	COD.	€ box
115	64220005001	5,609

3



3 BUSSOLE E ACCESSORI

SOCKETS AND ACCESSORIES

64220

BARRE A "T" SNODATE

BARRA A T SNODATA PER BUSSOLE 1/4" CON ASTA MOBILE
 SLIDING T BAR WITH UNIVERSAL JOINT FOR 1/4" SOCKETS

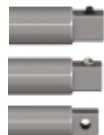

EASYPACK | sacchetto PVC con Euro-hole - PVC bags with Euro-hole

L mm	A/B/C	PCS.	COD.	€ cad./each
400	B	1	64220105	32,000

65999

GIRAVITE PORTABUSSOLE

GIRAVITE PORTABUSSOLE PER 1/4"
 SOCKET-HOLDER SCREWDRIVER FOR 1/4"

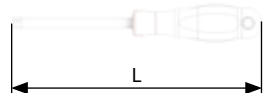
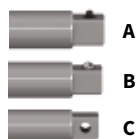

L mm	A/B/C	PCS.	COD.	€ cad./each
145	B	1	65999002	8,908

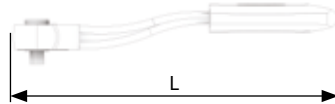
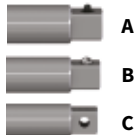

**64221****CRICCHETTI REVERSIBILI 72 DENTI****CRICCHETTO REVERSIBILE 72T**
72 TREVERSIBLE RATCHET

L mm	A/B/C	PCS.	COD.	€ cad./each
145	B	1	64221005	32,648

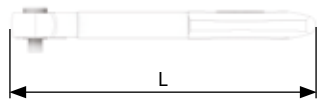
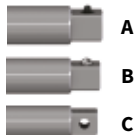
**64221****CRICCHETTI REVERSIBILI 45 DENTI****CRICCHETTO REVERSIBILE 45T**
45T REVERSIBLE RATCHET

L mm	A/B/C	PCS.	COD.	€ cad./each
160	B	1	64221006	17,248

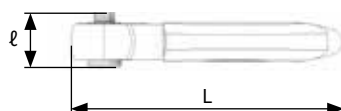
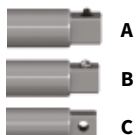
**64221****MINI-CRICCHETTI DOPPIA FUNZIONE****MINI-CRICCHETTO REVERSIBILE PER INSERTI E PER BUSSOLE**
REVERSIBLE MINI-RATCHET FOR BITS AND SOCKETS

L mm	A/B/C	PCS.	COD.	€ cad./each
105	B	1	64221020	25,133





3 BUSSOLE E ACCESSORI SOCKETS AND ACCESSORIES

64221

CRICCHETTI ONE-TOUCH

CRICCHETTO REVERSIBILE SISTEMA ONE-TOUCH
REVERSIBLE RATCHET ONE-TOUCH SYSTEM

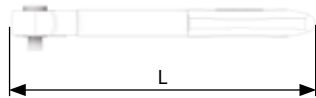
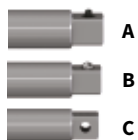

L mm	A/B/C	PCS.	COD.	€ cad./each
150	B	1	64221010	24,192



FOCUS ON



Movimento a 60 denti, ghiera di inversione della rotazione direttamente sul manico.
Movement with 60 teeth, reversal of the rotation of the ring nut directly on the handle.

64221

CRICCHETTI TELESCOPICI

CRICCHETTO REVERSIBILE CON ASTA TELESCOPICA
REVERSIBLE RATCHET WITH TELESCOPIC ROD

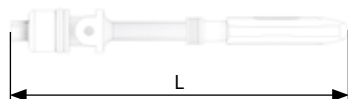
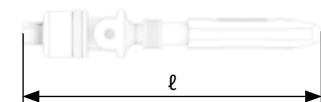
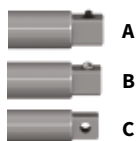

L mm	ℓ mm	A/B/C	PCS.	COD.	€ cad./each
245	197	B	1	64221015	30,240



FOCUS ON



Movimento a 36 denti, testa snodata ad alta resistenza, braccio telescopico.
Movement with 36 teeth, high-resistance jointed head, telescopic arm.



66001

STORE 6 ASSORTIMENTI BUSSOLE E ACCESSORI 1/4"

CASSETTIERA CON 6 SCOMPARTI PER ESPOSITORE MULTISTORE
DRAWERS WITH 6 COMPARTMENTS FOR MULTISTORE DISPLAY

105
pcs.



600 X 115 X 65 mm

COD. **66001110**

€ 222,824

64008

5,5 20pcs.	7 20pcs.	8 20pcs.	10 20pcs.	13 20pcs.
---------------	-------------	-------------	--------------	--------------

62101010



1/4"x1/4"x50mm
5pcs.



MULTI STORE

COD. 66001005VC

PER DETTAGLI E COMPOSIZIONE VEDERE p. 184
FOR DETAILS AND COMPOSITION SEE p. 184



3 BUSSOLE E ACCESSORI

SOCKETS AND ACCESSORIES

64026

SUPERLOCK 3/8"

BUSSOLE 3/8" CAVA ESAGONALE TIPO SUPER-LOCK
3/8" SUPER-LOCK HEXAGONAL RECESS SOCKETS

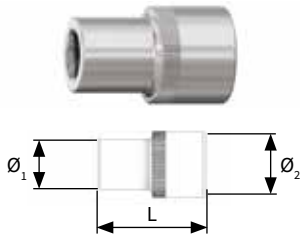

EASYPACK | sacchetto PVC con Euro-hole - PVC bags with Euro-hole

Icon	L mm	Ø ₁ mm	Ø ₂ mm	PCS.	COD.	€ cad./each
7	28	10,5	17	1	64026005	2,401
8	28	12	17	1	64026010	2,401
10	28	14,5	17	1	64026015	2,401
11	28	16	17	1	64026020	2,401
12	28	17	17	1	64026025	2,474
13	28	18	17	1	64026030	2,605
14	28	20	17	1	64026035	2,810
15	28	22	19	1	64026040	3,051
17	30	24	20	1	64026045	3,350
19	30	26	23	1	64026050	3,687
21	32	28	25	1	64026055	4,227
22	32	30	26	1	64026060	4,666
24	32	32	28	1	64026065	5,690

Icon	L mm	COD.	€ box
7	28	64026005001	3,051
8	28	64026010001	3,051
10	28	64026015001	3,051
11	28	64026020001	3,051
12	28	64026025001	3,124
13	28	64026030001	3,255
14	28	64026035001	3,460
15	28	64026040001	3,701
17	30	64026045001	4,000
19	30	64026050001	4,337
21	32	64026055001	4,877
22	32	64026060001	5,316
24	32	64026065001	6,340



SELPACK
1 pc.

64026

ASSORTIMENTI SUPERLOCK 3/8"

SERIE 8 PCS. BUSSOLE 3/8" SUPER-LOCK
8 PCS. SOCKETS SET 3/8" SUPER-LOCK



200 X 35 X 18 mm

8
pcs.

COD. **64026201**

€ 21,729

64026

7 1pc.	8 1pc.	10 1pc.	13 1pc.	15 1pc.	17 1pc.	19 1pc.	21 1pc.
-----------	-----------	------------	------------	------------	------------	------------	------------

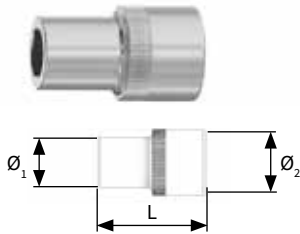
**64027****ESAGONALE 3/8"****BUSSOLE 3/8" CAVA ESAGONALE**
3/8" SOCKETS 6POINTS HEXAGON RECESS

EASYPACK | sacchetto PVC con Euro-hole - PVC bags with Euro-hole

●	L mm	Ø ₁ mm	Ø ₂ mm	PCS.	COD.	€ cad./each
6	28	10,2	17	1	64027006	2,401
7	28	10,7	17	1	64027010	2,401
8	28	12	17	1	64027015	2,401
9	28	13,2	17	1	64027020	2,401
10	28	14,5	17	1	64027025	2,401
11	28	15,7	17	1	64027030	2,401
12	28	17	17	1	64027035	2,474
13	28	18	17	1	64027040	2,605
14	28	20	17	1	64027045	2,810
15	28	22	19	1	64027050	3,051
16	30	22	19	1	64027055	3,051
17	30	24	20	1	64027060	3,350
18	30	26	23	1	64027065	3,716
19	30	26	23	1	64027070	3,687
20	32	28	25	1	64027075	4,227
21	32	28	25	1	64027080	4,227
22	32	30	26	1	64027085	4,666

●	L mm	Ø ₁ mm	Ø ₂ mm	PCS.	COD.	€ cad./each
6	28			1	64027006001	3,051
7	28			1	64027010001	3,051
8	28			1	64027015001	3,051
9	28			1	64027020001	3,051
10	28			1	64027025001	3,051
11	28			1	64027030001	3,051
12	28			1	64027035001	3,124
13	28			1	64027040001	3,255
14	28			1	64027045001	3,460
15	28			1	64027050001	3,701
16	28			1	64027055001	3,701
17	30			1	64027060001	4,000
18	30			1	64027065001	4,366
19	30			1	64027070001	4,337
20	30			1	64027075001	4,877
21	30			1	64027080001	4,877
22	30			1	64027085001	5,316

64027**ASSORTIMENTI BUSSOLE 3/8" ESAGONALI****SERIE 14 PCS. BUSSOLE 3/8" ESAGONALI**
14 PCS. SET 3/8" SOCKETS 6POINTS HEXAGONAL14
pcs.COD. **64027201**

€ 38,920

64027

8	9	10	11	12	13	14	15	16	17	18	19	21	22
1pc.	1pc.	1pc.	1pc.	1pc.	1pc.	1pc.	1pc.	1pc.	1pc.	1pc.	1pc.	1pc.	1pc.



3 BUSSOLE E ACCESSORI

SOCKETS AND ACCESSORIES

64028

ESAGONALE 3/8" LUNGHE

BUSSOLE 3/8" CAVA ESAGONALE TIPO LUNGO

3/8" SOCKETS 6POINTS HEXAGON RECESS LONG SERIES



EASYPACK | sacchetto PVC con Euro-hole - PVC bags with Euro-hole

	L mm	Ø ₁ mm	Ø ₂ mm	PCS.	COD.	€ cad./each
8	63	12	17	1	64028015	5,068
9	63	13,2	17	1	64028020	5,068
10	63	14,5	17	1	64028025	5,068
11	63	15,7	17	1	64028030	5,068
12	63	17	17	1	64028035	5,068
13	63	18	17	1	64028040	5,352
14	63	20	17	1	64028045	5,628
15	63	22	19	1	64028050	6,343
16	63	22	19	1	64028055	6,343
17	63	24	20	1	64028060	6,902
18	63	26	23	1	64028065	8,133
19	63	26	23	1	64028070	8,133
20	63	28	25	1	64028075	8,813
21	63	28	25	1	64028080	8,813
22	63	30	26	1	64028085	9,932

64028

ASSORTIMENTI BUSSOLE 3/8" ESAGONALI LUNGHE

SERIE 14 PCS. BUSSOLE 3/8" ESAGONALI TIPO LUNGO

14 PCS. SET 3/8" SOCKETS 6POINTS HEXAGONAL LONG SERIES



200 X 35 X 18 mm

14
pcs.

COD. **64028201**

€ 81,800

64028

8	9	10	11	12	13	14	15	16	17	18	19	21	22
1pc.	1pc.	1pc.	1pc.	1pc.	1pc.	1pc.	1pc.	1pc.	1pc.	1pc.	1pc.	1pc.	1pc.

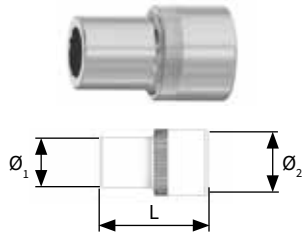
**64029****POLIGONALE 3/8"****BUSSOLE 3/8" CAVA POLIGONALE****3/8" SOCKETS 12POINTS DOUBLE-HEX RECESS**

EASYPACK | sacchetto PVC con Euro-hole - PVC bags with Euro-hole

	L mm	Ø ₁ mm	Ø ₂ mm	PCS.	COD.	€ cad./each
6	28	10,2	17	1	64029005	2,401
7	28	10,7	17	1	64029010	2,401
8	28	12	17	1	64029015	2,401
9	28	13,2	17	1	64029020	2,401
10	28	14,5	17	1	64029025	2,401
11	28	15,7	17	1	64029030	2,401
12	28	17	17	1	64029035	2,474
13	28	18	17	1	64029040	2,605
14	28	20	17	1	64029045	2,810
15	28	22	19	1	64029050	3,051
16	30	22	19	1	64029055	3,051
17	30	24	20	1	64029060	3,350
18	30	26	23	1	64029065	3,716
19	30	26	23	1	64029070	3,687
20	32	28	25	1	64029075	4,227
21	32	28	25	1	64029080	4,227
22	32	30	26	1	64029085	4,666

64029**ASSORTIMENTI BUSSOLE 3/8" POLIGONALI****SERIE 14 PCS. BUSSOLE 3/8" POLIGONALI****14 PCS. SET 3/8" SOCKETS 12POINTS DOUBLE-HEX****14
pcs.**COD. **64029201****€ 38,920**

64029

200 X 35 X 18 mm

8	9	10	11	12	13	14	15	16	17	18	19	21	22
1pc.	1pc.	1pc.	1pc.	1pc.	1pc.	1pc.	1pc.	1pc.	1pc.	1pc.	1pc.	1pc.	1pc.

3



3 BUSSOLE E ACCESSORI

SOCKETS AND ACCESSORIES

64030

POLIGONALE 3/8" LUNGHE

BUSSOLE 3/8" CAVA POLIGONALE TIPO LUNGO

3/8" SOCKETS 12POINTS DOUBLE-HEX RECESS LONG SERIES

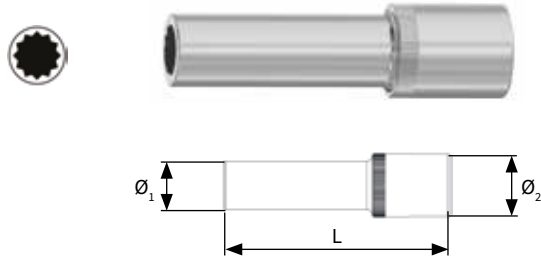

EASYPACK | sacchetto PVC con Euro-hole - PVC bags with Euro-hole

	L mm	Ø ₁ mm	Ø ₂ mm	PCS.	COD.	€ cad./each
8	63	12	17	1	64030015	5,068
9	63	13,2	17	1	64030020	5,068
10	63	14,5	17	1	64030025	5,068
11	63	15,7	17	1	64030030	5,068
12	63	17	17	1	64030035	5,068
13	63	18	17	1	64030040	5,352
14	63	20	17	1	64030045	5,628
15	63	22	19	1	64030050	6,343
16	63	22	19	1	64030055	6,343
17	63	24	20	1	64030060	6,902
18	63	26	23	1	64030065	8,133
19	63	26	23	1	64030070	8,133
20	63	28	25	1	64030075	8,813
21	63	28	25	1	64030080	8,813
22	63	30	26	1	64030085	9,932

64030

ASSORTIMENTI BUSSOLE 3/8" POLIGONALI LUNGHE

SERIE 14 PCS. BUSSOLE 3/8" POLIGONALI TIPO LUNGO

14 PCS. SET 3/8" SOCKETS 12POINTS DOUBLE-HEX LONG SERIES



200 X 35 X 18 mm

14
pcs.

COD. **64030201**

€ 81,800

64030

8	9	10	11	12	13	14	15	16	17	18	19	21	22
1pc.	1pc.	1pc.	1pc.	1pc.	1pc.	1pc.	1pc.	1pc.	1pc.	1pc.	1pc.	1pc.	1pc.



64086

POLIGONALE 3/8" SNODATE

BUSSOLE 3/8" CAVA POLIGONALE SNODATE

3/8" UNIVERSAL SOCKETS 12POINTS DOUBLE-HEX RECESS

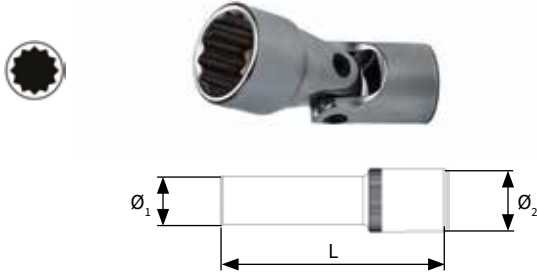

	L mm	Ø ₁ mm	Ø ₂ mm	PCS.	COD.	€ cad./each
10	49,5	14,5	19	1	64086025	10,708
11	50,5	15,8	19	1	64086030	10,708
12	51	17	19	1	64086035	10,800
13	52	18,3	19	1	64086040	10,800
14	52	20	19	1	64086045	10,952
15	54,5	22	19	1	64086050	11,104
16	54,5	22	19	1	64086055	11,104
17	55,5	24	19	1	64086060	11,104
18	55,5	26	19	1	64086065	11,620
19	57,5	26	19	1	64086070	11,620

64086

ASSORTIMENTI BUSSOLE 3/8" SNODATE

SERIE 10 PCS. BUSSOLE 3/8" ESAGONALI SNODATE

10 PCS. SET 3/8" UNIVERSAL SOCKETS 6POINTS HEXAGONAL



200 X 35 X 18 mm

10
pcs.

COD. **64086201**
€ 99,469

64086

10	11	12	13	14	15	16	17	18	19
1pc.	1pc.	1pc.	1pc.	1pc.	1pc.	1pc.	1pc.	1pc.	1pc.

3



3 BUSSOLE E ACCESSORI

SOCKETS AND ACCESSORIES

64128

CAVA TX(E) 3/8"

BUSSOLE 3/8" CAVA PER VITI TORX(E)

3/8" SOCKETS RECESS FOR TORX(E) BOLTS AND NUTS

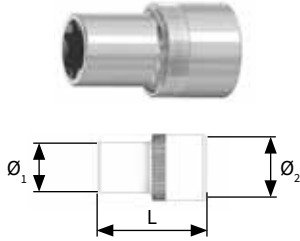

EASYPACK | sacchetto PVC con Euro-hole - PVC bags with Euro-hole

	L mm	Ø ₁ mm	Ø ₂ mm	PCS.	COD.	€ cad./each
E6	28	8,3	17	1	64128005	3,146
E7	28	8,9	17	1	64128010	3,146
E8	28	9,9	17	1	64128015	3,146
E10	28	12	17	1	64128020	3,146
E11	28	13,3	17	1	64128025	3,146
E12	28	14,5	17	1	64128030	3,146
E14	28	16,3	18	1	64128035	3,364
E16	28	20	18	1	64128040	3,693
E18	28	22	19	1	64128045	4,130
E20	30	24	19	1	64128050	4,419

64128

ASSORTIMENTI BUSSOLE 3/8" CAVA TX(E)

SERIE 10 PCS. BUSSOLE 3/8" CAVA PER VITI TX(E)

10 PCS. SET 3/8" SOCKETS FOR TORX(E) BOLTS AND NUTS



200 X 35 X 18 mm

10
pcs.

COD. **64128201**

€ 31,000

64128

E6	E7	E8	E10	E11	E12	E14	E16	E18	E20
1pc.	1pc.	1pc.	1pc.	1pc.	1pc.	1pc.	1pc.	1pc.	1pc.

64088

ESAGONALE 3/8" PER CANDELE

BUSSOLE 3/8" CAVA ESAGONALE PER CANDELE

3/8" SPARK PLUG SOCKETS



EASYPACK | sacchetto PVC con Euro-hole - PVC bags with Euro-hole

	L mm	Ø ₁ mm	Ø ₂ mm	PCS.	COD.	€ cad./each
16	65	22		1	64088010	6,600
21	65	28		1	64088020	8,600

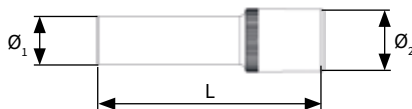

**64163****BUSSOLE CON INSERTO TX****BUSSOLE 3/8" CON INSERTO PER VITI TORX®**
3/8" SOCKETS WITH BIT FOR TORX® SCREWS

EASYPACK | sacchetto PVC con Euro-hole - PVC bags with Euro-hole

	L mm	Ø mm	PCS.	COD.	€ cad./each
TX20	48	17	1	64163005	5,483
TX25	48	17	1	64163010	5,483
TX27	48	17	1	64163015	5,483
TX30	48	17	1	64163020	5,483
TX40	48	17	1	64163025	5,483
TX45	48	17	1	64163030	5,483
TX50	48	17	1	64163035	5,483
TX55	48	17	1	64163040	5,483
TX60	48	17	1	64163045	5,483

SELFPACK
1 pc.

	L mm	COD.	€ box
TX20	48	64163005001	6,133
TX25	48	64163010001	6,133
TX27	48	64163015001	6,133
TX30	48	64163020001	6,133
TX40	48	64163025001	6,133
TX45	48	64163030001	6,133
TX50	48	64163035001	6,133

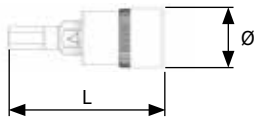
64161**BUSSOLE CON INSERTO ESAGONALE****BUSSOLE 3/8" CON INSERTO ESAGONALE**
3/8" SOCKETS WITH HEXAGONAL BIT

EASYPACK | sacchetto PVC con Euro-hole - PVC bags with Euro-hole

	L mm	Ø mm	PCS.	COD.	€ cad./each
3	48	17	1	64161005	5,483
4	48	17	1	64161010	5,483
5	48	17	1	64161015	5,483
6	48	17	1	64161020	5,483
8	48	17	1	64161025	5,483
10	48	17	1	64161030	5,483

SELFPACK
1 pc.

	L mm	COD.	€ box
3	48	64161005001	6,133
4	48	64161010001	6,133
5	48	64161015001	6,133
6	48	64161020001	6,133
8	48	64161025001	6,133
10	48	64161030001	6,133



3 BUSSOLE E ACCESSORI

SOCKETS AND ACCESSORIES

64163

ASSORTIMENTI BUSSOLE 3/8" CON INSERTO TX

ASSORTIMENTI BUSSOLE 3/8" CON INSERTO TX
 3/8" SOCKETS SETS WITH TX BIT



200 X 35 X 18 mm

9
pcs.

COD. **64163201**

€ 44,400



TX20	TX25	TX27	TX30	TX40	TX45	TX50	TX55	TX60
1pc.	1pc.	1pc.	1pc.	1pc.	1pc.	1pc.	1pc.	1pc.

64162

ASSORTIMENTI BUSSOLE 3/8" CON INSERTO ESAGONALE

ASSORTIMENTI BUSSOLE 3/8" CON INSERTO
 3/8" SOCKETS SETS WITH BIT



200 X 46 X 13 mm

6
pcs.

COD. **64162005**

€ 29,389



3	4	5	6	8	10
1pc.	1pc.	1pc.	1pc.	1pc.	1pc.



64162

BUSSOLE MORTORQ- SUPER®

ASSORTIMENTO 5 PCS. BUSSOLE 3/8" CON INSERTO MORTORQ-SUPER®
5 PCS 3/8" SOCKETS SET WITH MORTORQ-SUPER® BITS



130 X 60 X 20 mm

5
pcs.

COD. **64162100**

€ 51,968



MTS0	MTS1	MTS2	MTS3	MTS4
1pc.	1pc.	1pc.	1pc.	1pc.





3 BUSSOLE E ACCESSORI

SOCKETS AND ACCESSORIES

64201

ESTRATTORI BULLONI

ESTRATTORI 3/8" E 1/2" PER DADI E BULLONI
3/8" AND 1/2" EXTRACTORS FOR NUTS AND BOLTS

40/44 HRC



EASYPACK | sacchetto PVC con Euro-hole - PVC bags with Euro-hole

		L mm	PCS.	COD.	€ cad./each
3/8"	8	32	1	64201005	15,904
3/8"	10	32	1	64201010	15,904
3/8"	11	32	1	64201015	15,904
3/8"	12	32	1	64201020	15,904
3/8"	13	32	1	64201025	16,912
3/8"	14	32	1	64201030	18,592
1/2"	15	34	1	64201035	19,152
1/2"	16	34	1	64201040	19,152
1/2"	17	34	1	64201045	20,832
1/2"	18	34	1	64201050	22,176
1/2"	19	34	1	64201055	22,176

64202

ASSORTIMENTI ESTRATTORI BULLONI

ASSORTIMENTO 11 PCS. ESTRATTORI
11 PCS. EXTRACTORS SET

11
pcs.

COD. **64202005**
€ 168,000



340 X 50 X 50 mm

64201



8	10	11	12	13	14	15	16	17	18	19
1pc.	1pc.	1pc.	1pc.	1pc.	1pc.	1pc.	1pc.	1pc.	1pc.	1pc.



64200

ESTRATTORI BULLONI DANNEGGIATI

ESTRATTORI 3/8" PER DADI E BULLONI DANNEGGIATI
3/8" EXTRACTORS FOR DAMAGED NUTS AND BOLTS



EASYPACK | sacchetto PVC con Euro-hole - PVC bags with Euro-hole

	L mm	PCS.	COD.	€ cad./each
	8 30	1	64200005	6,899
	10 30	1	64200010	6,899
	13 30	1	64200015	7,202
	17 30	1	64200020	8,848

66036

SET ESTRATTORI 3/8" PER BULLONI

ASSORTIMENTO 4 PCS. ESTRATTORI PER DADI E BULLONI
4 PCS. NUTS AND BOLTS EXTRACTORS SET

58/60 HRC



65 X 105 X 45 mm

4
pcs.

EASYPACK | sacchetto PVC con Euro-hole - PVC bags with Euro-hole

COD. **66036005**
€ **32,032**

64200			
8	10	13	17
1pc.	1pc.	1pc.	1pc.

3



3 BUSSOLE E ACCESSORI

SOCKETS AND ACCESSORIES

62185

PROLUNGHE

PROLUNGA PER BUSSOLE 3/8"
EXTENSION FOR 3/8" SOCKETS

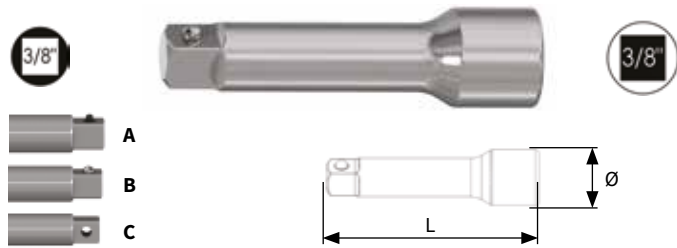

EASYPACK | sacchetto PVC con Euro-hole - PVC bags with Euro-hole

L mm	A/B/C	Ø mm	PCS.	COD.	€ cad./each
45	B	17	1	62185005	4,357
150	B	17	1	62185010	7,806



SELFPACK
1 pc.

L mm	COD.	€ box
45	62185005001	4,979
150	62185010001	8,469

62185

PROLUNGHE SEMI-SNODO

PROLUNGA A DUE VIE - RETTILINEA + ANGOLARE PER BUSSOLE 3/8"
EXTENSION 2WAY - STRAIGHT + WOBBLE FOR 3/8" SOCKETS

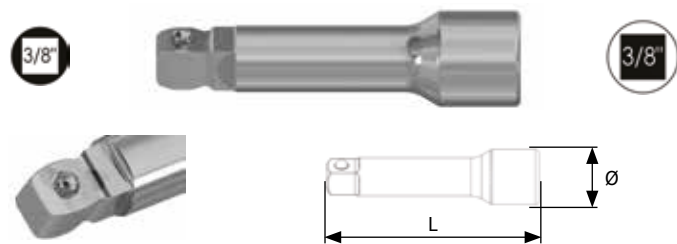

EASYPACK | sacchetto PVC con Euro-hole - PVC bags with Euro-hole

L mm	Ø mm	PCS.	COD.	€ cad./each
75	17,5	1	62185105	6,000
150	17,5	1	62185110	7,800

62186

PROLUNGHE SNODATE

PROLUNGA PER BUSSOLE 3/8" SNODATA
EXTENSION FOR 3/8" ARTICULATED SOCKETS

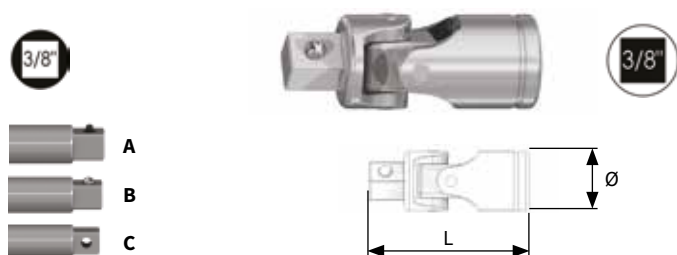

EASYPACK | sacchetto PVC con Euro-hole - PVC bags with Euro-hole

L mm	A/B/C	Ø mm	PCS.	COD.	€ cad./each
56	B	17	1	62186005	8,098



SELFPACK
1 pc.

L mm	COD.	€ box
56	62186005001	8,638

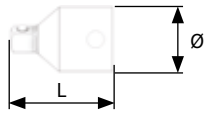
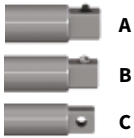
**62104****RIDUZIONI****RIDUZIONE 3/8" PER BUSSOLE DA 1/4"**
3/8" REDUCTION FOR 1/4" SOCKETS

EASYPACK sacchetto PVC con Euro-hole - PVC bags with Euro-hole					
L mm	A/B/C	Ø mm	PCS.	COD.	€ cad./each
27	B	17	1	62104001	3,850

SELFPACK
1 pc.

L mm	COD.	€ box
27	62104001001	4,486

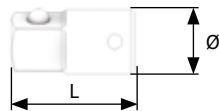
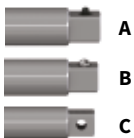
62124**ADATTATORI/AUMENTATORI****ADATTATORE/AUMENTATORE 3/8" PER BUSSOLE DA 1/2"**
3/8" ADAPTER/ENHANCER FOR 1/2" SOCKETS

EASYPACK sacchetto PVC con Euro-hole - PVC bags with Euro-hole					
L mm	A/B/C	Ø mm	PCS.	COD.	€ cad./each
36	B	18	1	62124001	4,726

SELFPACK
1 pc.

L mm	COD.	€ box
36	62124001001	5,355

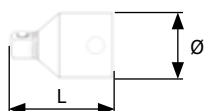
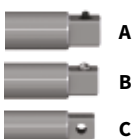
62124**ADATTATORI PER BUSSOLE 1/2" SCORREVOLE
PER PROLUNGHE****ADATTATORE/AUMENTATORE 3/8" PER BUSSOLE DA 1/2" SCORREVOLE PRE PROLUNGHE 1/2"**
3/8" ADAPTER/ENHANCER FOR 1/2" SOCKETS, SLIDING FOR 1/2" EXTENSIONS

EASYPACK sacchetto PVC con Euro-hole - PVC bags with Euro-hole					
L mm	A/B/C	Ø mm	PCS.	COD.	€ cad./each
44	B	24	1	62124002	5,500



3 BUSSOLE E ACCESSORI

SOCKETS AND ACCESSORIES

64222

BARRE A "T"

BARRA A T PER BUSSOLE 3/8" CON ASTA MOBILE
SLIDING T BAR FOR 3/8" SOCKETS

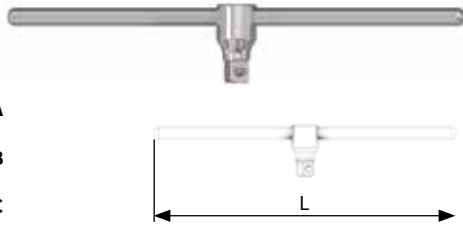
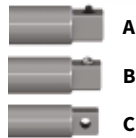

EASYPACK | sacchetto PVC con Euro-hole - PVC bags with Euro-hole

L mm	A/B/C	PCS.	COD.	€ cad./each
200	B	1	64222010	11,400

64222

BARRE A "T" SNODATE

BARRA A T SNODATA PER BUSSOLE 3/8" CON ASTA MOBILE
SLIDING T BAR WITH UNIVARSAL JOINT FOR 3/8" SOCKETS

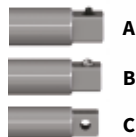

EASYPACK | sacchetto PVC con Euro-hole - PVC bags with Euro-hole

L mm	A/B/C	PCS.	COD.	€ cad./each
400	B	1	64222105	36,000

64222

CRICCHETTI A "T"

CRICCHETTO REVERSIBILE PER 3/8" CON IMPUGNATURA A "T"
REVERSIBLE RATCHET FOR 3/8" WITH T-SHAPED HANDLE

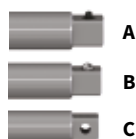

EASYPACK | sacchetto PVC con Euro-hole - PVC bags with Euro-hole

L mm	A/B/C	PCS.	COD.	€ cad./each
200	B	5	64222005	35,840 €



64223

CRICCHETTI REVERSIBILI 72 DENTI

CRICCHETTO REVERSIBILE 72T
72 TREVERSIBLE RATCHET

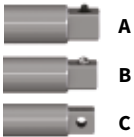

L mm	A/B/C	PCS.	COD.	€ cad./each
200	B	1	64223005	35,482



64223

CRICCHETTI REVERSIBILI 45 DENTI

CRICCHETTO REVERSIBILE 45T
45T REVERSIBLE RATCHET

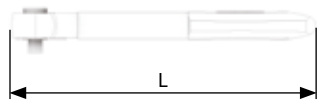
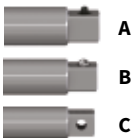

L mm	A/B/C	PCS.	COD.	€ cad./each
205	B	1	64223006	22,176



3



3 BUSSOLE E ACCESSORI

SOCKETS AND ACCESSORIES

64223

CRICCHETTI ONE-TOUCH

CRICCHETTO REVERSIBILE SISTEMA ONE-TOUCH
 REVERSIBLE RATCHET ONE-TOUCH SYSTEM

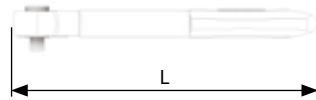
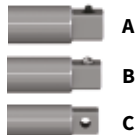

L mm	A/B/C	PCS.	COD.	€ cad./each
200	B	1	64223010	45,584



FOCUS ON



Movimento a 60 denti, ghiera di inversione della rotazione direttamente sul manico.
 Movement with 60 teeth, reversal of the rotation of the ring nut directly on the handle.

64223

CRICCHETTI TELESCOPICI

CRICCHETTO REVERSIBILE CON ASTA TELESCOPICA
 REVERSIBLE RATCHET WITH TELESCOPIC ROD

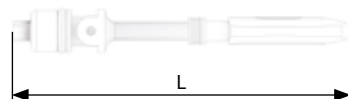
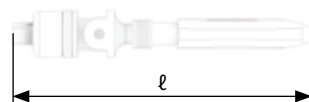
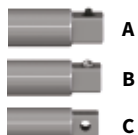

L mm	ℓ mm	A/B/C	PCS.	COD.	€ cad./each
375	273	B	1	64223015	36,736



FOCUS ON



Movimento a 36 denti, testa snodata ad alta resistenza, braccio telescopico.
 Movement with 36 teeth, high-resistance jointed head, telescopic arm.



66001

STORE 6 ASSORTIMENTI BUSSOLE E ACCESSORI 3/8"



CASSETTIERA CON 6 SCOMPARTI PER ESPOSITORE MULTISTORE
DRAWERS WITH 6 COMPARTMENTS FOR MULTISTORE DISPLAY

105
pcs.

COD. **66001115**
€ 261,990



600 X 115 X 65 mm

64026 					62111010 
7 20pcs.	8 20pcs.	10 20pcs.	13 20pcs.	17 20pcs.	1/4"x3/8"x50mm 5pcs.



MULTI STORE

COD. 66001005VC

PER DETTAGLI E COMPOSIZIONE VEDERE p.184
FOR DETAILS AND COMPOSITION SEE p. 184



3 BUSSOLE E ACCESSORI SOCKETS AND ACCESSORIES

64048 SUPERLOCK 1/2"

BUSSOLE 1/2" CAVA ESAGONALE TIPO SUPER-LOCK
1/2" SOCKETS SUPER-LOCK HEXAGON RECESS

40/44 HRC

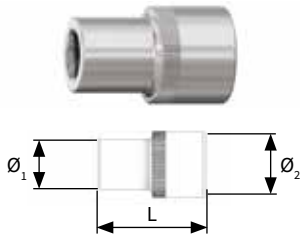

EASYPACK | sacchetto PVC con Euro-hole - PVC bags with Euro-hole

●	L mm	Ø ₁ mm	Ø ₂ mm	PCS.	COD.	€ cad./each
10	38	15,5	22	1	64048005	3,169
11	38	16,5	22	1	64048010	3,169
12	38	18	22	1	64048015	3,169
13	38	19,5	22	1	64048020	3,169
14	38	20,2	22	1	64048025	3,169
15	38	22	22	1	64048030	3,169
16	38	24	22	1	64048035	3,169
17	38	24	22	1	64048040	3,501
18	38	26	24	1	64048045	3,942
19	38	26	24	1	64048050	3,942
20	38	28	25	1	64048055	4,236
21	38	30	25	1	64048060	4,236
22	38	30	26	1	64048065	4,677
23	38	32	28	1	64048070	5,303
24	38	32	28	1	64048075	5,303
27	38	36	32	1	64048080	6,985
30	38	40	34	1	64048085	8,672
32	38	42	36	1	64048090	9,261

●	L mm	COD.	€ box
10	38	64048005001	3,819
11	38	64048010001	3,819
12	38	64048015001	3,819
13	38	64048020001	3,819
14	38	64048025001	3,819
15	38	64048030001	3,819
16	38	64048035001	3,819
17	38	64048040001	4,151
18	38	64048045001	4,592
19	38	64048050001	4,592
20	38	64048055001	4,886
21	38	64048060001	4,886
22	38	64048065001	5,327
23	38	64048070001	5,953
24	38	64048075001	5,953
27	38	64048080001	7,635
30	38	64048085001	9,322
32	38	64048090001	9,911



SELFPACK
1 pc.

64048 ASSORTIMENTI BUSSOLE 1/2" SUPER-LOCK

SERIE 8 PCS. BUSSOLE 1/2" CAVA ESAGONALE TIPO SUPER-LOCK
8 PCS. SET 1/2" SOCKETS SUPER-LOCK



200 X 35 X 18 mm

8
pcs.

COD. 64048201

€ 25,639

64048

10 1pc.	13 1pc.	15 1pc.	16 1pc.	17 1pc.	18 1pc.	19 1pc.	21 1pc.
------------	------------	------------	------------	------------	------------	------------	------------

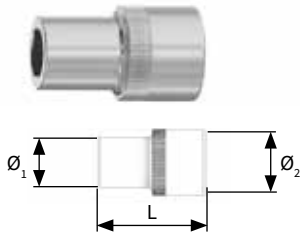
**64051****ESAGONALE 1/2"****BUSSOLE 1/2" CAVA ESAGONALE**
1/2" SOCKETS 6POINTS HEXAGON RECESS

EASYPACK | sacchetto PVC con Euro-hole - PVC bags with Euro-hole

	L mm	Ø ₁ mm	Ø ₂ mm	PCS.	COD.	€ cad./each
8	38	13,2	22	1	64051005	3,169
9	38	13,8	22	1	64051010	3,169
10	38	15	22	1	64051015	3,169
11	38	16,3	22	1	64051020	3,169
12	38	17,6	22	1	64051025	3,169
13	38	18,8	22	1	64051030	3,169
14	38	20,3	22	1	64051035	3,169
15	38	21,5	22	1	64051040	3,169
16	38	22	22	1	64051045	3,169
17	38	24	22	1	64051050	3,501
18	38	26	23	1	64051055	3,942
19	38	26	23	1	64051060	3,942
20	38	28	24	1	64051065	4,236
21	38	28	25	1	64051070	4,236
22	40	30	26	1	64051075	4,677
23	40	32	27	1	64051080	5,303
24	42	32	28	1	64051085	5,303
25	42	34	30	1	64051090	6,154
26	42	36	30	1	64051095	6,985
27	43	36	30	1	64051100	6,985
28	43	38	32	1	64051105	8,135
29	43	38	32	1	64051110	8,135
30	46	40	34	1	64051115	8,672
32	46	42	36	1	64051120	9,261

	L mm	PCS.	COD.	€ cad./each
8	38	1	64051005001	3,819
9	38	1	64051010001	3,819
10	38	1	64051015001	3,819
11	38	1	64051020001	3,819
12	38	1	64051025001	3,819
13	38	1	64051030001	3,819
14	38	1	64051035001	3,819
15	38	1	64051040001	3,819
16	38	1	64051045001	3,819
17	38	1	64051050001	4,151
18	38	1	64051055001	4,592
19	38	1	64051060001	4,592
20	38	1	64051065001	4,886
21	38	1	64051070001	4,886
22	38	1	64051075001	5,327
23	38	1	64051080001	5,953
24	38	1	64051085001	5,953
25	42	1	64051090001	6,804
26	42	1	64051095001	7,635
27	42	1	64051100001	7,635
28	42	1	64051105001	8,785
29	42	1	64051110001	8,785
30	44	1	64051115001	9,322
32	44	1	64051120001	9,911

SELFPACK
1 pc.



3 BUSSOLE E ACCESSORI

SOCKETS AND ACCESSORIES

64051

ASSORTIMENTI BUSSOLE 1/2" ESAGONALI

SERIE 12 PCS. BUSSOLE 1/2" ESAGONALI
 12 PCS. SET 1/2" SOCKETS 6POINTS HEXAGONAL



200 X 35 X 18 mm

12
pcs.

COD. **64051201**
 € 38,300



10	11	12	13	14	15	16	17	18	19	21	22
1pc.	1pc.	1pc.	1pc.	1pc.	1pc.	1pc.	1pc.	1pc.	1pc.	1pc.	1pc.



64052

ESAGONALE 1/2" LUNGHE

BUSSOLE 1/2" CAVA ESAGONALE TIPO LUNGO

1/2" SOCKETS 6POINTS HEXAGON RECESS LONG SERIES

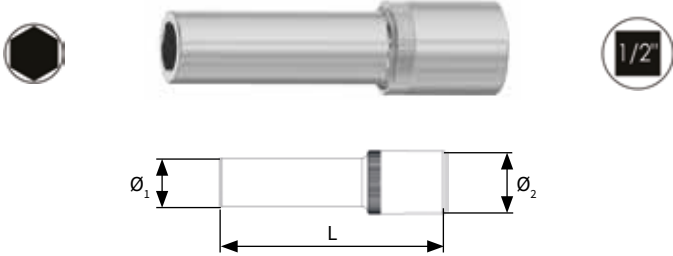

EASYPACK | sacchetto PVC con Euro-hole - PVC bags with Euro-hole

	L mm	Ø ₁ mm	Ø ₂ mm	PCS.	COD.	€ cad./each
10	77	15	22	1	64052015	6,383
12	77	17,6	22	1	64052025	6,383
13	77	18,8	22	1	64052030	6,383
14	77	20,3	22	1	64052035	6,383
15	77	21,5	22	1	64052040	6,383
16	77	22	22	1	64052045	6,383
17	77	24	22	1	64052050	6,660
18	77	26	23	1	64052055	7,491
19	77	26	23	1	64052060	7,491
21	77	28	25	1	64052070	8,102
22	77	30	26	1	64052075	9,423
23	77	32	27	1	64052080	10,098
24	77	32	28	1	64052085	10,098
27	77	36	30	1	64052100	13,095
30	77	40	34	1	64052115	16,234
32	77	42	36	1	64052120	17,733

3

64052

ASSORTIMENTI BUSSOLE 1/2" ESAGONALI LUNGHE

SERIE 12 PCS. BUSSOLE 1/2" ESAGONALI TIPO LUNGO

12 PCS. SET 1/2" SOCKETS" 6POINTS HEXAGONAL LONG SERIES



200 X 35 X 18 mm

12
pcs.

COD. **64052201**

€ 78,800



10	12	13	14	15	16	17	18	19	21	22	24
1pc.	1pc.	1pc.	1pc.	1pc.	1pc.	1pc.	1pc.	1pc.	1pc.	1pc.	1pc.



3 BUSSOLE E ACCESSORI

SOCKETS AND ACCESSORIES

64053

POLIGONALE 1/2"

BUSSOLE 1/2" CAVA POLIGONALE

1/2" SOCKETS 12POINTS DOUBLE-HEX RECESS

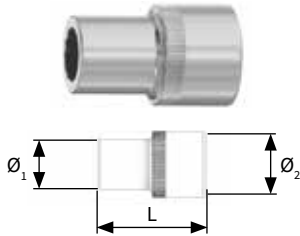

EASYPACK | sacchetto PVC con Euro-hole - PVC bags with Euro-hole

Ø	L mm	Ø ₁ mm	Ø ₂ mm	PCS.	COD.	€ cad./each
8	38	13,2	22	1	64053005	3,169
9	38	13,8	22	1	64053010	3,169
10	38	15	22	1	64053015	3,169
11	38	16,3	22	1	64053020	3,169
12	38	17,6	22	1	64053025	3,169
13	38	18,8	22	1	64053030	3,169
14	38	20,3	22	1	64053035	3,169
15	38	21,5	22	1	64053040	3,169
16	38	22	22	1	64053045	3,169
17	38	24	22	1	64053050	3,501
18	38	26	23	1	64053055	3,942
19	38	26	23	1	64053060	3,942
20	38	28	24	1	64053065	4,236
21	38	28	25	1	64053070	4,236
22	40	30	26	1	64053075	4,677
23	40	32	27	1	64053080	5,303
24	42	32	28	1	64053085	5,303
25	42	34	30	1	64053090	6,154
26	42	36	30	1	64053095	6,985
27	43	36	30	1	64053100	6,985
28	43	38	32	1	64053105	8,135
29	43	38	32	1	64053110	8,135
30	46	40	34	1	64053115	8,672
32	46	42	36	1	64053120	9,261

64053

ASSORTIMENTI BUSSOLE 1/2" POLIGONALI

SERIE 12 PCS. BUSSOLE 1/2" POLIGONALI

12 PCS. SET 1/2" SOCKETS 12POINTS DOUBLE-HEX



200 X 35 X 18 mm

12
pcs.

COD. **64053201**

€ **38,300**

64053

10	11	12	13	14	15	16	17	18	19	21	22
1pc.	1pc.	1pc.	1pc.	1pc.	1pc.	1pc.	1pc.	1pc.	1pc.	1pc.	1pc.



64054

POLIGONALE 1/2" LUNGHE

BUSSOLE 1/2" CAVA POLIGONALE TIPO LUNGO

1/2" SOCKETS 12POINTS DOUBLE-HEX RECESS LONG SERIES



EASYPACK | sacchetto PVC con Euro-hole - PVC bags with Euro-hole

	L mm	Ø ₁ mm	Ø ₂ mm	PCS.	COD.	€ cad./each
10	77	15	22	1	64054015	6,383
12	77	17,6	22	1	64054025	6,383
13	77	18,8	22	1	64054030	6,383
14	77	20,3	22	1	64054035	6,383
15	77	21,5	22	1	64054040	6,383
16	77	22	22	1	64054045	6,383
17	77	24	22	1	64054050	6,660
18	77	26	23	1	64054055	7,491
19	77	26	23	1	64054060	7,491
21	77	28	25	1	64054070	8,102
22	77	30	26	1	64054075	9,423
23	77	32	27	1	64054080	10,098
24	77	32	28	1	64054085	10,098
27	77	36	30	1	64054100	13,095
30	77	40	34	1	64054115	16,234
32	77	42	36	1	64054120	17,733

3

64054

ASSORTIMENTI BUSSOLE 1/2" POLIGONALI LUNGHE

SERIE 12 PCS. BUSSOLE 1/2" POLIGONALI TIPO LUNGO

12 PCS. SET 1/2" SOCKETS 12POINTS DOUBLE-HEX LONG SERIES



200 X 35 X 18 mm

12
pcs.

COD. **64054201**

€ 78,800

64054

10	12	13	14	15	16	17	18	19	21	22	24
1pc.	1pc.	1pc.	1pc.	1pc.	1pc.	1pc.	1pc.	1pc.	1pc.	1pc.	1pc.



3 BUSSOLE E ACCESSORI

SOCKETS AND ACCESSORIES

64129

CAVA TX(E) 1/2"

BUSSOLE 1/2" CAVA PER VITI TORX(E)

1/2" SOCKETS RECESS FOR TORX(E) BOLTS AND NUTS

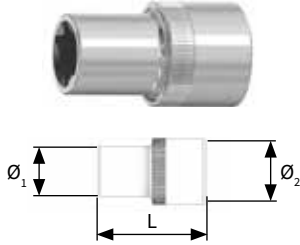

EASYPACK | sacchetto PVC con Euro-hole - PVC bags with Euro-hole

	L mm	Ø ₁ mm	Ø ₂ mm	PCS.	COD.	€ cad./each
E10	38	13,2	22	1	64129005	4,599
E11	38	13,8	22	1	64129010	4,599
E12	38	15	22	1	64129015	4,599
E14	38	16,7	22	1	64129020	4,599
E16	38	19	22	1	64129025	4,599
E18	38	21	22	1	64129030	4,920
E20	38	24	22	1	64129035	5,177
E22	38	26	23	1	64129040	5,935
E24	38	28	24	1	64129045	6,552

64129

ASSORTIMENTI BUSSOLE 1/2" CAVA TX(E)

SERIE 9 PCS. BUSSOLE 1/2" CAVA PER VITI TX(E)

9 PCS. SET 1/2" SOCKETS FOR TORX(E) BOLTS AND NUTS



200 X 35 X 18 mm

9
pcs.

COD. **64129201**

€ 41,000

64129

E10	E11	E12	E14	E16	E18	E20	E22	E24
1pc.	1pc.	1pc.	1pc.	1pc.	1pc.	1pc.	1pc.	1pc.

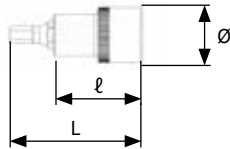
**64171****BUSSOLE CON INSERTO ESAGONALE****BUSSOLE 1/2" CON INSERTO ESAGONALE**
1/2" SOCKETS WITH HEXAGON BIT**40/44 HRC**

EASYPACK] sacchetto PVC con Euro-hole - PVC bags with Euro-hole

Ø	L mm	ℓ mm	Ø mm	PCS.	COD.	€ cad./each
4	55	38	22	1	64171005	7,045
4	100	38	22	1	64171010	8,264
5	55	38	22	1	64171015	7,045
5	100	38	22	1	64171020	8,264
6	55	38	22	1	64171025	7,045
6	100	38	22	1	64171030	8,264
7	55	38	22	1	64171035	7,045
7	100	38	22	1	64171040	8,264
8	55	38	22	1	64171045	7,045
8	100	38	22	1	64171050	8,264
10	55	38	22	1	64171055	7,045
10	100	38	22	1	64171060	8,264
12	55	38	22	1	64171065	7,045
12	100	38	22	1	64171070	8,264
14	55	38	22	1	64171075	7,045
14	100	38	22	1	64171080	8,264

Ø	L mm	COD.	€ box
4	55	64171005001	7,695
4	100	64171010001	8,914
5	55	64171015001	7,695
5	100	64171020001	8,914
6	55	64171025001	7,695
6	100	64171030001	8,914
7	55	64171035001	7,695
7	100	64171040001	8,914
8	55	64171045001	7,695
8	100	64171050001	8,914
10	55	64171055001	7,695
10	100	64171060001	8,914
12	55	64171065001	7,695
12	100	64171070001	8,914
14	55	64171075001	7,695
14	100	64171080001	8,914

SELPACK
1 pc.



3 BUSSOLE E ACCESSORI

SOCKETS AND ACCESSORIES

64172

BUSSOLE CON INSERTO TX

BUSSOLE 1/2" CON INSERTO PER VITI TORX®
1/2" SOCKETS WITH BIT FOR TORX® SCREWS

40/44 HRC

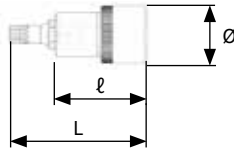

EASYPACK | sacchetto PVC con Euro-hole - PVC bags with Euro-hole

	L mm	ℓ mm	Ø mm	PCS.	COD.	€ cad./each
TX10	60	38	22	1	64172005	8,288
TX10	100	38	22	1	64172010	9,722
TX15	60	38	22	1	64172015	8,288
TX15	100	38	22	1	64172020	9,722
TX20	55	38	22	1	64172025	8,288
TX20	100	38	22	1	64172030	9,722
TX25	55	38	22	1	64172035	8,288
TX25	100	38	22	1	64172040	9,722
TX27	55	38	22	1	64172045	8,288
TX27	100	38	22	1	64172050	9,722
TX30	55	38	22	1	64172055	8,288
TX30	100	38	22	1	64172060	9,722
TX40	55	38	22	1	64172065	8,288
TX40	100	38	22	1	64172070	9,722
TX45	55	38	22	1	64172075	8,288
TX45	100	38	22	1	64172080	9,722
TX50	55	38	22	1	64172085	8,288
TX50	100	38	22	1	64172090	9,722
TX55	55	38	22	1	64172095	8,288
TX55	100	38	22	1	64172100	9,722
TX60	55	38	22	1	64172105	8,288
TX60	100	38	22	1	64172110	9,722
TX70	55	38	22	1	64172115	8,288

	L mm	COD.	€ box
TX10	60	64172005001	8,938
TX10	100	64172010001	10,372
TX15	60	64172015001	8,938
TX15	100	64172020001	10,372
TX20	55	64172025001	8,938
TX20	100	64172030001	10,372
TX25	55	64172035001	8,938
TX25	100	64172040001	10,372
TX27	55	64172045001	8,938
TX27	100	64172050001	10,372
TX30	55	64172055001	8,938
TX30	100	64172060001	10,372
TX40	55	64172065001	8,938
TX40	100	64172070001	10,372
TX45	55	64172075001	8,938
TX45	100	64172080001	10,372
TX50	55	64172085001	8,938
TX50	100	64172090001	10,372
TX55	55	64172095001	8,938
TX55	100	64172100001	10,372

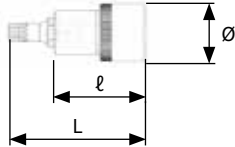

SELFPACK
1 pc.

**64173****BUSSOLE CON INSERTO TXH****BUSSOLE 1/2" CON INSERTO PER VITI TORX® ANTI-MANOMISSIONE****1/2" SOCKETS WITH BIT FOR TORX® TAMPER-RESISTANT SCREWS****40/44 HRC**

EASYPACK | sacchetto PVC con Euro-hole - PVC bags with Euro-hole

	L mm	ℓ mm	Ø mm	PCS.	COD.	€ cad./each
TXH10	60	38	22	1	64173005	8,646
TXH10	100	38	22	1	64173010	10,080
TXH15	60	38	22	1	64173015	8,646
TXH15	100	38	22	1	64173020	10,080
TXH20	60	38	22	1	64173025	8,646
TXH20	100	38	22	1	64173030	10,080
TXH25	60	38	22	1	64173035	8,646
TXH25	100	38	22	1	64173040	10,080
TXH27	60	38	22	1	64173045	8,646
TXH27	100	38	22	1	64173050	10,080
TXH30	60	38	22	1	64173055	8,646
TXH30	100	38	22	1	64173060	10,080
TXH40	60	38	22	1	64173065	8,646
TXH40	100	38	22	1	64173070	10,080
TXH45	60	38	22	1	64173075	8,646
TXH45	100	38	22	1	64173080	10,080
TXH50	60	38	22	1	64173085	8,646
TXH50	100	38	22	1	64173090	10,080
TXH55	60	38	22	1	64173095	8,646
TXH55	100	38	22	1	64173100	10,080



	L mm	COD.	€ box
TXH10	60	64173005001	9,296
TXH10	100	64173010001	10,730
TXH15	60	64173015001	9,296
TXH15	100	64173020001	10,730
TXH20	60	64173025001	9,296
TXH20	100	64173030001	10,730
TXH25	60	64173035001	9,296
TXH25	100	64173040001	10,730
TXH27	60	64173045001	9,296
TXH27	100	64173050001	10,730
TXH30	60	64173055001	9,296
TXH30	100	64173060001	10,730
TXH40	60	64173065001	9,296
TXH40	100	64173070001	10,730
TXH45	60	64173075001	9,296
TXH45	100	64173080001	10,730
TXH50	60	64173085001	9,296
TXH50	100	64173090001	10,730
TXH55	60	64173095001	9,296
TXH55	100	64173100001	10,730

SELFPACK
1 pc.



3 BUSSOLE E ACCESSORI

SOCKETS AND ACCESSORIES

64175

BUSSOLE CON INSERTO RIBE

BUSSOLE 1/2" CON INSERTO RIBE®
1/2" SOCKETS WITH RIBE® BIT

40/44 HRC

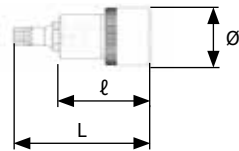

EASYPACK | sacchetto PVC con Euro-hole - PVC bags with Euro-hole

	L mm	ℓ mm	Ø mm	PCS.	COD.	€ cad./each
M4	60	38	22	1	64175005	8,288
M4	100	38	22	1	64175010	9,722
M5	60	38	22	1	64175015	8,288
M5	100	38	22	1	64175020	9,722
M6	60	38	22	1	64175025	8,288
M6	100	38	22	1	64175030	9,722
M7	60	38	22	1	64175035	8,288
M7	100	38	22	1	64175040	9,722
M8	60	38	22	1	64175045	8,288
M8	100	38	22	1	64175050	9,722
M9	60	38	22	1	64175055	8,288
M9	100	38	22	1	64175060	9,722
M10	60	38	22	1	64175065	8,288
M10	100	38	22	1	64175070	9,722
M12	60	38	22	1	64175075	8,288
M12	100	38	22	1	64175080	9,722
M14	60	38	22	1	64175085	8,288
M14	100	38	22	1	64175090	9,722
M16	60	38	22	1	64175095	8,288
M16	100	38	22	1	64175100	9,722

	L mm	COD.	€ box
M4	60	64175005001	8,938
M4	100	64175010001	10,372
M5	60	64175015001	8,938
M5	100	64175020001	10,372
M6	60	64175025001	8,938
M6	100	64175030001	10,372
M7	60	64175035001	8,938
M7	100	64175040001	10,372
M8	60	64175045001	8,938
M8	100	64175050001	10,372
M9	60	64175055001	8,938
M9	100	64175060001	10,372
M10	60	64175065001	8,938
M10	100	64175070001	10,372
M12	60	64175075001	8,938
M12	100	64175080001	10,372
M14	60	64175085001	8,938
M14	100	64175090001	10,372
M16	60	64175095001	8,938
M16	100	64175100001	10,372

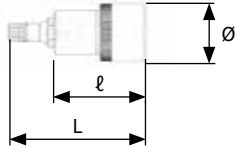

SELPACK
1 pc.

**64176****BUSSOLE CON INSERTO RIBE-H****BUSSOLE 1/2" CON INSERTO RIBE® CON FORO**
1/2" SOCKETS WITH RIBE® WITH HOLE BIT**40/44 HRC**

EASYPACK | sacchetto PVC con Euro-hole - PVC bags with Euro-hole

	L mm	ℓ mm	Ø mm	PCS.	COD.	€ cad./each
MH4	60	38	22	1	64176005	8,646
MH4	100	38	22	1	64176010	10,080
MH5	60	38	22	1	64176015	8,646
MH5	100	38	22	1	64176020	10,080
MH6	60	38	22	1	64176025	8,646
MH6	100	38	22	1	64176030	10,080
MH7	60	38	22	1	64176035	8,646
MH7	100	38	22	1	64176040	10,080
MH8	60	38	22	1	64176045	8,646
MH8	100	38	22	1	64176050	10,080
MH9	60	38	22	1	64176055	8,646
MH9	100	38	22	1	64176060	10,080
MH10	60	38	22	1	64176065	8,646
MH10	100	38	22	1	64176070	10,080
MH12	60	38	22	1	64176075	8,646
MH12	100	38	22	1	64176080	10,080

	L mm	COD.	€ box
MH4	60	64176005001	9,296
MH4	100	64176010001	10,730
MH5	60	64176015001	9,296
MH5	100	64176020001	10,730
MH6	60	64176025001	9,296
MH6	100	64176030001	10,730
MH7	60	64176035001	9,296
MH7	100	64176040001	10,730
MH8	60	64176045001	9,296
MH8	100	64176050001	10,730
MH9	60	64176055001	9,296
MH9	100	64176060001	10,730
MH10	60	64176065001	9,296
MH10	100	64176070001	10,730
MH12	60	64176075001	9,296
MH12	100	64176080001	10,730

SELFPACK
1 pc.



3 BUSSOLE E ACCESSORI

SOCKETS AND ACCESSORIES

64174

BUSSOLE CON INSERTO XZN

BUSSOLE 1/2" CON INSERTO XZN

1/2" SOCKETS WITH XZN BIT

40/44 HRC

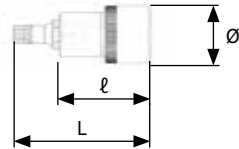

EASYPACK | sacchetto PVC con Euro-hole - PVC bags with Euro-hole

Ø	L mm	ℓ mm	Ø mm	PCS.	COD.	€ cad./each
M5	60	38	22	1	64174005	8,646
M5	100	38	22	1	64174010	10,080
M6	60	38	22	1	64174015	8,646
M6	100	38	22	1	64174020	10,080
M8	60	38	22	1	64174025	8,646
M8	100	38	22	1	64174030	10,080
M10	60	38	22	1	64174035	8,646
M10	100	38	22	1	64174040	10,080
M12	60	38	22	1	64174045	8,646
M12	100	38	22	1	64174050	10,080
M14	60	38	22	1	64174055	8,646
M14	100	38	22	1	64174060	10,080
M16	55	38	22	1	64174066	12,656
M18	55	38	22	1	64174075	15,344
M20	55	38	22	1	64174085	20,720

Ø	L mm	COD.	€ box
M5	60	64174005001	9,296
M5	100	64174010001	10,730
M6	60	64174015001	9,296
M6	100	64174020001	10,730
M8	60	64174025001	9,296
M8	100	64174030001	10,730
M10	60	64174035001	9,296
M10	100	64174040001	10,730
M12	60	64174045001	9,296
M12	100	64174050001	10,730
M14	60	64174055001	9,296
M14	100	64174060001	10,730
M16	55	64174066001	13,306
M18	55	64174075001	15,994
M20	55	64174085001	21,370



SELPACK
1 pc.



64177

ASSORTIMENTI BUSSOLE 1/2" CON INSERTO TX E TXH

ASSORTIMENTI BUSSOLE 1/2" CON INSERTO 1/2" SOCKETS SETS WITH BIT



10
pcs.

200 X 46 X 13 mm

COD. **64177003**

€ 66,300

64172x55mm

TX20	TX25	TX27	TX30	TX40	TX45	TX50	TX55	TX60	TX70
1pc.	1pc.	1pc.	1pc.	1pc.	1pc.	1pc.	1pc.	1pc.	1pc.



9
pcs.

200 X 46 X 13 mm

COD. **64177004**

€ 70,000

64172x100mm

TX20	TX25	TX27	TX30	TX40	TX45	TX50	TX55	TX60
1pc.	1pc.	1pc.	1pc.	1pc.	1pc.	1pc.	1pc.	1pc.



8
pcs.

200 X 46 X 13 mm

COD. **64177005**

€ 55,326

64173x60mm

TXH20	TXH25	TXH27	TXH30	TXH40	TXH45	TXH50	TXH55
1pc.	1pc.	1pc.	1pc.	1pc.	1pc.	1pc.	1pc.



8
pcs.

200 X 46 X 13 mm

COD. **64177006**

€ 64,603

64173x100mm

TXH20	TXH25	TXH27	TXH30	TXH40	TXH45	TXH50	TXH55
1pc.	1pc.	1pc.	1pc.	1pc.	1pc.	1pc.	1pc.

3



3 BUSSOLE E ACCESSORI

SOCKETS AND ACCESSORIES

64177

ASSORTIMENTI BUSSOLE 1/2" CON INSERTO RIBE E RIBE-H

ASSORTIMENTI BUSSOLE 1/2" CON INSERTO
1/2" SOCKETS SETS WITH BIT



8 pcs.

200 X 46 X 13 mm

COD. **64177011**

€ 53,122

64175x60mm

M6	M7	M8	M9	M10	M12	M14	M16
1pc.	1pc.	1pc.	1pc.	1pc.	1pc.	1pc.	1pc.



8 pcs.

200 X 46 X 13 mm

COD. **64177012**

€ 62,186

64175x100mm

M6	M7	M8	M9	M10	M12	M14	M16
1pc.	1pc.	1pc.	1pc.	1pc.	1pc.	1pc.	1pc.



6 pcs.

200 X 46 X 13 mm

COD. **64177015**

€ 41,492

64176x60mm

MH6	MH7	MH8	MH9	MH10	MH12
1pc.	1pc.	1pc.	1pc.	1pc.	1pc.



6 pcs.

200 X 46 X 13 mm

COD. **64177016**

€ 48,319

64176x100mm

MH6	MH7	MH8	MH9	MH10	MH12
1pc.	1pc.	1pc.	1pc.	1pc.	1pc.



64177

ASSORTIMENTI BUSSOLE 1/2" CON INSERTO ESAGONALE E XZN

ASSORTIMENTI BUSSOLE 1/2" CON INSERTO
1/2" SOCKETS SETS WITH BIT



200 X 46 X 13 mm

8 pcs.

COD. **64177021**
€ 45,040

64171x55mm

4	5	6	7	8	10	12	14
1pc.	1pc.	1pc.	1pc.	1pc.	1pc.	1pc.	1pc.



200 X 46 X 13 mm

8 pcs.

COD. **64177022**
€ 52,809

64171x100mm

4	5	6	7	8	10	12	14
1pc.	1pc.	1pc.	1pc.	1pc.	1pc.	1pc.	1pc.



200 X 46 X 13 mm

6 pcs.

COD. **64177025**
€ 41,492

64174x60mm

M5	M6	M8	M10	M12	M14
1pc.	1pc.	1pc.	1pc.	1pc.	1pc.



200 X 46 X 13 mm

6 pcs.

COD. **64177026**
€ 48,379

64174x100mm

M5	M6	M8	M10	M12	M14
1pc.	1pc.	1pc.	1pc.	1pc.	1pc.



3 BUSSOLE E ACCESSORI

SOCKETS AND ACCESSORIES

62195

PROLUNGHE

PROLUNGA PER BUSSOLE 1/2"
EXTENSION FOR 1/2" SOCKETS

40/44 HRC

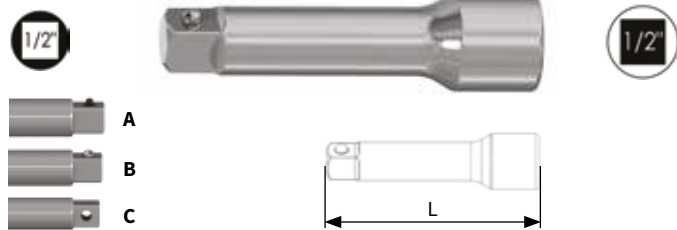

EASYPACK | sacchetto PVC con Euro-hole - PVC bags with Euro-hole

L mm	A/B/C	Ø mm	PCS.	COD.	€ cad./each
50	B	22	1	62195005	6,482
125	B	22	1	62195010	11,491
150	B	22	1	62195015	12,902
250	B	22	1	62195020	15,725

L mm	COD.	€ box
50	62195005001	7,136
125	62195010001	12,186
150	62195015001	13,581
250	62195020001	16,278



SELPACK
1 pc.

62195

PROLUNGHE SEMI-SNODO

PROLUNGA A DUE VIE - RETTILINEA + ANGOLARE PER BUSSOLE 1/2"
EXTENSION 2WAY - STRAIGHT + WOBBLE FOR 1/2" SOCKETS

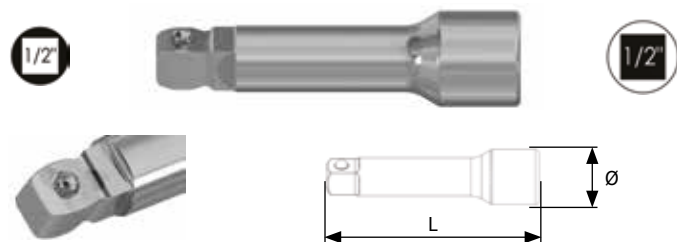

EASYPACK | sacchetto PVC con Euro-hole - PVC bags with Euro-hole

L mm	Ø mm	PCS.	COD.	€ cad./each
75	24	1	62195105	7,800
125	24	1	62195110	10,600
250	24	1	62195115	16,400

62196

PROLUNGHE SNODATE

PROLUNGA PER BUSSOLE 1/2" SNODATA
UNIVERSAL JOINT FOR 1/2" SOCKETS

40/44 HRC



EASYPACK | sacchetto PVC con Euro-hole - PVC bags with Euro-hole

L mm	A/B/C	Ø mm	PCS.	COD.	€ cad./each
73	B	22	1	62196005	12,656



SELPACK
1 pc.

L mm	COD.	€ box
73	62196005001	13,265



62116

RIDUZIONI

RIDUZIONE 1/2" PER BUSSOLE DA 3/8"

1/2" REDUCTION FOR 3/8" SOCKETS

40/44 HRC

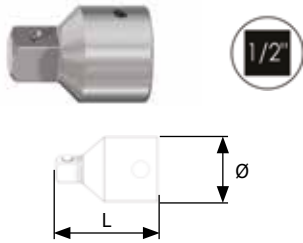
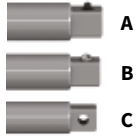

EASYPACK | sacchetto PVC con Euro-hole - PVC bags with Euro-hole

L mm	A/B/C	Ø mm	PCS.	COD.	€ cad./each
36	B	22	1	62116001	4,726



SELPACK
1 pc.

L mm	COD.	€ box
36	62116001001	5,355

62135

ADATTATORI/AUMENTATORI

ADATTATORE/AUMENTATORE 1/2" PER BUSSOLE DA 3/4"

1/2" ADAPTER/ENHANCER FOR 3/4" SOCKETS

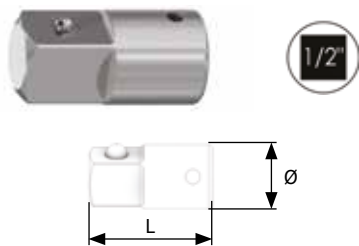
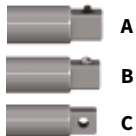

EASYPACK | sacchetto PVC con Euro-hole - PVC bags with Euro-hole

L mm	A/B/C	Ø mm	PCS.	COD.	€ cad./each
47	B	26	1	62135001	9,413



SELPACK
1 pc.

L mm	COD.	€ box
47	62135001001	10,058



3 BUSSOLE E ACCESSORI

SOCKETS AND ACCESSORIES

64224

BARRE A "T"

LEVA PER BUSSOLE CON ASTA MOBILE
LEVER FOR SOCKETS WITH MOBILE ROD

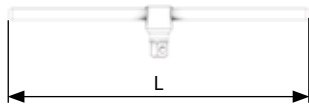
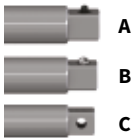

L mm	A/B/C	PCS.	COD.	€ cad./each
300	B	1	64224001	16,240



SELFPACK
1 pc.

L mm	COD.	€ box
300	64224001001	16,882

64224

CRICCHETTI REVERSIBILI 72 DENTI

CRICCHETTO REVERSIBILE 72T
72 TREVERSIBLE RATCHET

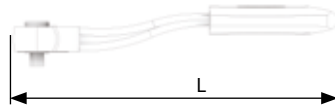
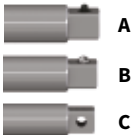

L mm	A/B/C	PCS.	COD.	€ cad./each
250	B	1	64224005	49,526



64224

CRICCHETTI REVERSIBILI 45 DENTI

CRICCHETTO REVERSIBILE 45T
45T REVERSIBLE RATCHET

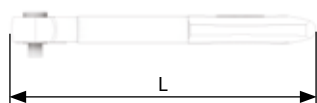
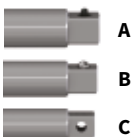

L mm	A/B/C	PCS.	COD.	€ cad./each
255	B	1	64224006	27,104



**64224**

CRICCHETTI ONE-TOUCH

CRICCHETTO REVERSIBILE SISTEMA ONE-TOUCH
REVERSIBLE RATCHET ONE-TOUCH SYSTEM

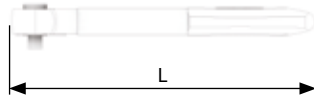
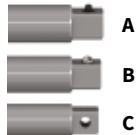

L mm	A/B/C	PCS.	COD.	€ cad./each
245	B	1	64224010	56,000



FOCUS ON



Movimento a 60 denti, ghiera di inversione della rotazione direttamente sul manico.
Movement with 60 teeth, reversal of the rotation of the ring nut directly on the handle.

64224

CRICCHETTI TELESCOPICI

CRICCHETTO REVERSIBILE CON ASTA TELESCOPICA
REVERSIBLE RATCHET WITH TELESCOPIC ROD

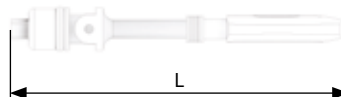
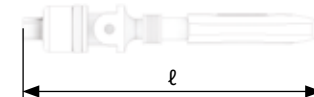
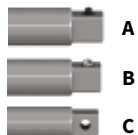

L mm	ℓ mm	A/B/C	PCS.	COD.	€ cad./each
508	368	B	1	64224015	52,416



FOCUS ON



Movimento a 36 denti, testa snodata ad alta resistenza, braccio telescopico.
Movement with 36 teeth, high-resistance jointed head, telescopic arm.



3 BUSSOLE E ACCESSORI

SOCKETS AND ACCESSORIES

64065 ESAGONALE 3/4"

BUSSOLE 3/4" CAVA ESAGONALE
3/4" SOCKETS 6POINTS HEXAGONAL RECESS

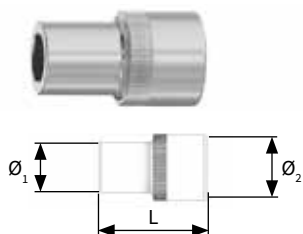

EASYPACK | sacchetto PVC con Euro-hole - PVC bags with Euro-hole

Ø	L mm	Ø ₁ mm	Ø ₂ mm	PCS.	COD.	€ cad./each
19	50	29	33	1	64065015	11,786
21	50	31	33	1	64065025	11,786
22	50	32	36	1	64065030	11,786
23	50	33	36	1	64065035	11,786
24	51	34	36	1	64065040	11,786
26	52	38	36	1	64065050	12,452
27	52	38	36	1	64065055	12,452
28	52	40	38	1	64065060	13,496
29	52	40	38	1	64065065	13,496
30	54	42	38	1	64065070	14,036
32	56	44	38	1	64065075	15,270
33	56	46	38	1	64065080	17,636
34	56	46	38	1	64065085	17,636
35	58	48	42	1	64065090	19,352
36	58	50	42	1	64065095	19,811
38	60	52	45	1	64065100	21,173
41	64	56	45	1	64065115	24,693
46	68	62	47	1	64065130	28,572
50	72	68	48	1	64065140	31,749
55	76	74	48	1	64065145	42,406
60	78	80	48	1	64065160	49,805

64065 ASSORTIMENTI BUSSOLE 3/4"

SERIE 9 PCS. BUSSOLE 3/4" ESAGONALI IN CASSETTA METALLICA
9 PCS. SET 3/4" SOCKETS 6POINTS HEXAGONAL WITH METAL CASE



9
pcs.

COD. **64065301**
€ 132,300

64065

19	22	24	27	30	32	34	36	41
1pc.	1pc.	1pc.	1pc.	1pc.	1pc.	1pc.	1pc.	1pc.

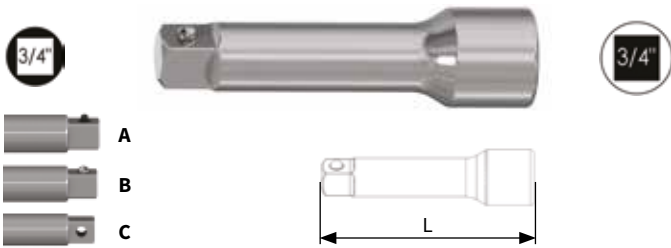
**62208****PROLUNGHE****PROLUNGA PER BUSSOLE 3/4"**
EXTENSION FOR 3/4" SOCKETS

EASYPACK sacchetto PVC con Euro-hole - PVC bags with Euro-hole					
100	B	36	1	62208005	20,000
200	B	36	1	62208015	28,000

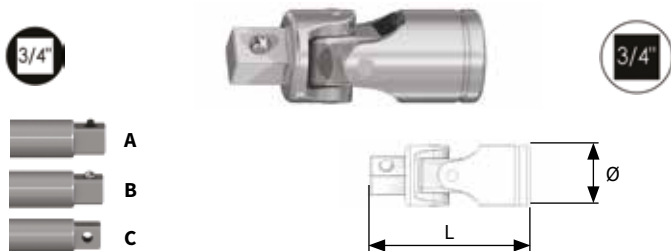
62209**PROLUNGHE SNODATE****PROLUNGA PER BUSSOLE 3/4" SNODATA**
UNIVERSAL JOINT FOR 3/4" SOCKETS

EASYPACK sacchetto PVC con Euro-hole - PVC bags with Euro-hole					
L mm	Ø mm	PCS.		COD.	€ cad./each
108	40	1		62209005	54,000

62126**RIDUZIONI****RIDUZIONE 3/4" PER BUSSOLE DA 1/2"**
3/4" REDUCTION FOR 1/2" SOCKETS

EASYPACK sacchetto PVC con Euro-hole - PVC bags with Euro-hole					
L mm	A/B/C	Ø mm	PCS.	COD.	€ cad./each
50	B	32	1	62126001	9,413

**SELFPACK**
1 pc.

L mm		COD.	€ box
50		62126001001	10,058



3 BUSSOLE E ACCESSORI

SOCKETS AND ACCESSORIES

64225

CRICCHETTI REVERSIBILI 43 DENTI

CRICCHETTO REVERSIBILE 3/4" 43T

43T 3/4" REVERSIBLE RATCHET



EASYPACK | sacchetto PVC con Euro-hole - PVC bags with Euro-hole

L mm	A/B/C	PCS.	COD.	€ cad./each
500	B	1	64225005	104,000

64225

BARRE A "T"

BARRA A T PER BUSSOLE 3/4" CON ASTA MOBILE

SLIDING T BAR FOR 3/4" SOCKETS

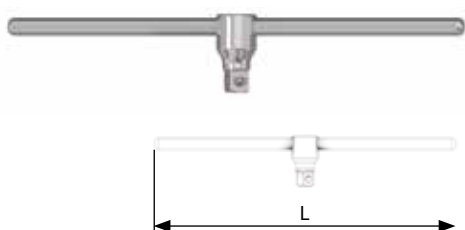
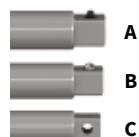

EASYPACK | sacchetto PVC con Euro-hole - PVC bags with Euro-hole

L mm	A/B/C	PCS.	COD.	€ cad./each
450	B	1	64225001	48,000

62602

SET RIDUZIONI-ADATTATORI

ASSORTIMENTO 6 PCS. RIDUZIONI / ADATTATORI

6PCS. REDUCTIONS / ADAPTERS SET



130 X 50 X 100 mm

6
pcs.

COD. **62602001**

€ 32,278

1pc.	1pc.	1pc.	1pc.	1pc.	1pc.	1pc.	1pc.	1pc.	1pc.	1pc.	1pc.

**64300****SET BUSSOLE ED ACCESSORI****ASSORTIMENTI 14 PCS. BUSSOLE ED ACCESSORI CON CRICCHETTO**

14 PCS. SOCKETS AND ACCESSORIES SET SWITH RATCHET

14
pcs.COD. **64300001**

€ 34,104

64008

4	5	6	7	8	9	10	11	12	13	14
1pc.	1pc.	1pc.	1pc.	1pc.	1pc.	1pc.	1pc.	1pc.	1pc.	1pc.

INCLUSO
INCLUDED

120 X 330 X 45 mm

COD. 62173005

COD. 62083005

COD. 64221005

14
pcs.COD. **64300010**

€ 45,864

64008

8	9	10	11	12	13	14	15	16	17	19
1pc.	1pc.	1pc.	1pc.	1pc.	1pc.	1pc.	1pc.	1pc.	1pc.	1pc.

INCLUSO
INCLUDED

120 X 330 X 45 mm

COD. 62185005

COD. 62186005

COD. 64223005

13
pcs.COD. **64300020**

€ 57,624

64008

10	11	12	13	14	17	19	21	22	24
1pc.	1pc.	1pc.	1pc.	1pc.	1pc.	1pc.	1pc.	1pc.	1pc.

INCLUSO
INCLUDED

140 X 39 X 55 mm

COD. 62195010

COD. 62196005

COD. 64224005







64230

SET BUSSOLE, ACCESSORI E INSERTI 1/4"

ASSORTIMENTO 18 PCS. BUSSOLE ED ACCESSORI 1/4" IN VALIGETTA METALLICA

18 PCS. 1/4" SOCKETS AND ACCESSORIES SET IN METAL CASE



18
pcs.

250 X 170 X 50 mm



COD. **64230001**

€ 69,000

64009

4	4,5	5	5,5	6	7	8	9	10	11	12	13	14
1pc.	1pc.	1pc.	1pc.	1pc.	1pc.	1pc.	1pc.	1pc.	1pc.	1pc.	1pc.	1pc.

INCLUSO / INCLUDED

COD. 62173005



50mm

COD. 62173007



100mm

COD. 62174005



COD. 64220005



COD. 64221005





3 BUSSOLE E ACCESSORI

SOCKETS AND ACCESSORIES

64230

SET BUSSOLE, ACCESSORI E INSERTI 1/4"

ASSORTIMENTO 39 PCS. BUSSOLE ED ACCESSORI 1/4" IN VALIGETTA METALLICA
39 PCS. SOCKETS AND 1/4" ACCESSORIES SET IN METAL CASE

39
pcs.



245 X 120 X 35 mm



COD. **64230005**

€ 83,776

64150		64151		64149		
PH1	PH2	PZ1	PZ2	0,6x4,0	0,8x5,5	1,2x7,0
1pc.	1pc.	1pc.	1pc.	1pc.	1pc.	1pc.

64147						
TX10	TX15	TX20	TX25	TX27	TX30	TX40
1pc.	1pc.	1pc.	1pc.	1pc.	1pc.	1pc.

64145					
3	4	5	6	7	8
1pc.	1pc.	1pc.	1pc.	1pc.	1pc.

64008													
4	4,5	5	5,5	6	7	8	9	10	11	12	13	14	
1pc.	1pc.	1pc.	1pc.	1pc.	1pc.	1pc.	1pc.	1pc.	1pc.	1pc.	1pc.	1pc.	

INCLUSO
INCLUDED

COD. 62173005



COD. 62173010



COD. 62174005



COD. 64220005



COD. 64221005



COD. 65999002





64230

SET BUSSOLE, ACCESSORI E INSERTI 1/4"

ASSORTIMENTO 46 PCS. BUSSOLE ED ACCESSORI 1/4" VALIGETTA IN TERMOFORMATO
46 PCS 1/4" SOCKETS AND ACCESSORIES SET IN BLOW MOLD CASE

46
pcs.



250 X 170 X 50 mm



COD. **64230008**

€ 49,392

64150			64151			64149						
PH1	PH2	PH3	PZ1	PZ2	PZ3	4	5,5	7				
1pc.	1pc.	1pc.	1pc.	1pc.	1pc.	1pc.	1pc.	1pc.				
64147												
TX10	TX15	TX20	TX25	TX30	TX40							
1pc.	1pc.	1pc.	1pc.	1pc.	1pc.							
64145												
3	4	5	6	7	8							
1pc.	1pc.	1pc.	1pc.	1pc.	1pc.							
64008												
4	4,5	5	5,5	6	7	8	9	10	11	12	13	14
1pc.	1pc.	1pc.	1pc.	1pc.	1pc.	1pc.	1pc.	1pc.	1pc.	1pc.	1pc.	1pc.

INCLUSO
INCLUDED

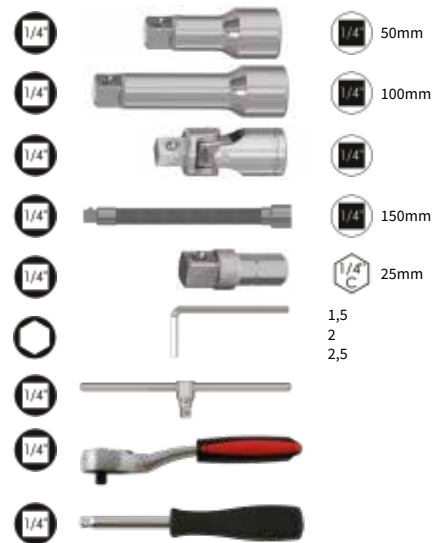

3



3 BUSSOLE E ACCESSORI SOCKETS AND ACCESSORIES

64230

SET BUSSOLE, ACCESSORI 1/4" CON CHIAVI COMBinate



















































ASSORTIMENTO 40 PCS. BUSSOLE ED ACCESSORI 1/4" CON CHIAVI COMBinate
40 PCS 1/4" SOCKETS AND ACCESSORIES SET WITH COMBINATION WRENCHES

40
pcs.

COD. **64230009**
€ 55,507



245 X 120 X 35 mm

		4,0	5,5	6,0	7,0				
		PH1	PH2	PH3					
		TX10	TX20	TX25	TX27	TX30	TX40		
		4	5	6	8				
		4	4,5	5	5,5	6	7	8	
		9	10	11	12	13	14		
									
									
									
		50							
									
									
									
									
									
									
									
									
									
									
									
									
									
									
									
									
									
									
									
									
									
									
									
									
									
									
									
									
									
									
									





64230

SET BUSSOLE, ACCESSORI E INSERTI 3/8"

ASSORTIMENTO 30 PCS. BUSSOLE ED ACCESSORI 3/8" IN VALIGETTA METALLICA
30 PCS. SOCKETS AND 3/8" ACCESSORIES SET IN METAL CASE



30
pcs.

315 X 140 X 45 mm



COD. **64230010**

€ 113,344

64163 

64161 

T20	T25	T27	T30	T40	T45	T50	3	4	5	6	8	10
1pc.	1pc.	1pc.	1pc.	1pc.	1pc.	1pc.	1pc.	1pc.	1pc.	1pc.	1pc.	1pc.

64026 

7	8	10	11	12	13	14	15	17	19	21	22	24
1pc.	1pc.	1pc.	1pc.	1pc.	1pc.	1pc.	1pc.	1pc.	1pc.	1pc.	1pc.	1pc.

INCLUSO
INCLUDED

COD. 62185005



COD. 62185010



COD. 62186005



COD. 64223005





3 BUSSOLE E ACCESSORI

SOCKETS AND ACCESSORIES

64230

SET BUSSOLE, ACCESSORI 3/8"

ASSORTIMENTO 26 PCS. BUSSOLE ED ACCESSORI 3/8" VALIGETTA IN TERMOFORMATO
26 PCS 3/8" SOCKETS AND ACCESSORIES SET IN BLOW MOLD CASE



26
pcs.

COD. **64230013**

€ 56,213



6	7	8	9	10	11	12	13	14
1pc.	1pc.	1pc.	1pc.	1pc.	1pc.	1pc.	1pc.	1pc.
15	16	17	18	19	20	21	22	24
1pc.	1pc.	1pc.	1pc.	1pc.	1pc.	1pc.	1pc.	1pc.

345 X 260 X 85 mm



INCLUSO
INCLUDED

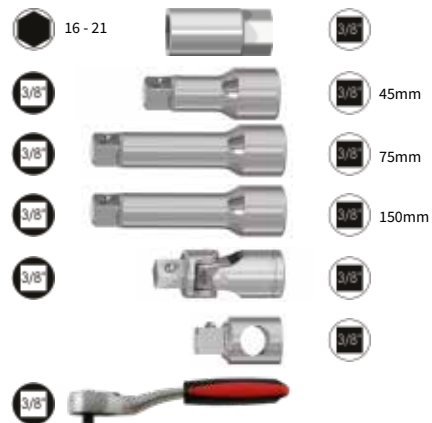



64230

SET BUSSOLE E ACCESSORI 1/2"

ASSORTIMENTO 23 PCS. BUSSOLE ED ACCESSORI 1/2" IN VALIGETTA METALLICA
23 PCS. SOCKETS AND 1/2" ACCESSORIES SET IN METAL CASE

23
pcs.

COD. **64230015**

€ 142,912

64048  

10 1pc.	11 1pc.	12 1pc.	13 1pc.	14 1pc.	15 1pc.	16 1pc.	17 1pc.	18 1pc.
19 1pc.	20 1pc.	21 1pc.	22 1pc.	23 1pc.	24 1pc.	27 1pc.	30 1pc.	32 1pc.



445 X 190 X 50 mm



INCLUSO
INCLUDED

COD. 62195005



50mm

COD. 62195010



125mm

COD. 62195015



150mm

COD. 62196005



COD. 64224005





3 BUSSOLE E ACCESSORI

SOCKETS AND ACCESSORIES

64230

SET BUSSOLE E ACCESSORI 1/2"

ASSORTIMENTO 25 PCS. BUSSOLE ED ACCESSORI 1/2" IN VALIGETTA METALLICA
 25 PCS. 1/2" SOCKETS AND ACCESSORIES SET IN METAL CASE



445 X 188 X 50 mm



25
pcs.

COD. **64230017**

€ 158,000

64051  

10	12	13	14	15	16	17	18	19	22	24	27	30	32
1pc.	1pc.	1pc.	1pc.	1pc.	1pc.	1pc.	1pc.	1pc.	1pc.	1pc.	1pc.	1pc.	1pc.



64052  

10	13	17	19
1pc.	1pc.	1pc.	1pc.

64088  

16	21
1pc.	1pc.

INCLUSO / INCLUDED

- COD. 62195010    125mm
- COD. 62195020    250mm
- COD. 62196005   
- COD. 64224001  
- COD. 64224005   



64230

SET BUSSOLE, ACCESSORI 1/2"

ASSORTIMENTO 32 PCS. BUSSOLE ED ACCESSORI 1/2" VALIGETTA IN TERMOFORMATO
32 PCS 1/2" SOCKETS AND ACCESSORIES SET IN BLOW MOLD CASE

32
pcs.

COD. **64230018**

€ 92,551



345 X 260 X 85 mm



8	9	10	11	12	13	14	15	16	17
1pc.	1pc.	1pc.	1pc.	1pc.	1pc.	1pc.	1pc.	1pc.	1pc.

18	19	20	21	22	24	27	30	32
1pc.	1pc.	1pc.	1pc.	1pc.	1pc.	1pc.	1pc.	1pc.



10	12	14	15	17	19
1pc.	1pc.	1pc.	1pc.	1pc.	1pc.

INCLUSO
INCLUDED



3



3 BUSSOLE E ACCESSORI

SOCKETS AND ACCESSORIES

64230

SET BUSSOLE E ACCESSORI 3/4"

ASSORTIMENTO 20 PCS. BUSSOLE ED ACCESSORI 3/4" IN VALIGETTA METALLICA
 20 PCS. SOCKETS AND 3/4" ACCESSORIES SET IN METAL CASE

20
pcs.



540 X 180 X 80 mm



COD. **64230020**

€ 370,832

3/4"



19 1pc.	21 1pc.	22 1pc.	23 1pc.	24 1pc.	26 1pc.	27 1pc.	29 1pc.
30 1pc.	32 1pc.	35 1pc.	36 1pc.	38 1pc.	41 1pc.	46 1pc.	50 1pc.

INCLUSO
INCLUDED

COD. 62208005



100mm

COD. 62208015



200mm

COD. 64225001



450mm

COD. 64225005



500mm



64230

SET BUSSOLE E ACCESSORI 1/4" E 1/2"

ASSORTIMENTO 54 PCS. BUSSOLE ED ACCESSORI 1/4" E 1/2"

54 SOCKETS AND ACCESSORIES 1/4" AND 1/2" SET



380 X 290 X 80 mm



54
pcs.

COD. **64230022**

€ 124,215

	3	4	5,5	6				
	PH1	PH2	PH3					
	PZ1	PZ2	PZ3					
	TX10	TX15	TX20	TX25	TX27	TX30		
	3	4	5	6				
		4	4,5	5	5,5	6	7	8
		9	10	11	12	13		
		13	17	19	20	21		
		22	24	27	30	32		
		100						
		125	250					
								40
								73
								16
								21



3 BUSSOLE E ACCESSORI SOCKETS AND ACCESSORIES

64230

SET BUSSOLE E ACCESSORI 1/4" E 1/2"

ASSORTIMENTO 82 PCS. BUSSOLE ED ACCESSORI 1/4" E 1/2" CON CHIAVI A CRICCHETTO
82 SOCKETS AND ACCESSORIES 1/4" AND 1/2" SET WITH RATCHET WRENCHES

82
pcs.



380 X 290 X 80 mm



cricchetto
ratchet

COD. **64230024**

€ 185,808

	8,0	10,0	12,0						
	PH3	PH4							
	PZ3	PZ4							
	TX40	TX45	TX50	TX55					
	8	10	12	14					
	4,0	5,0	7,0						
	PH1	PH2							
	PZ1	PZ2							
	TX8	TX10	TX15	TX20	TX25	TX30			
	3	4	5	6					
	4	4,5	5	5,5	6	7	8		
	9	10	11	12	13	14			
	14	15	16	17	18	19	20		
	22	24	27	30	32				
	8	10	11	12	13	14	17	19	22
			40			50	100		
			73			125	250		
				16					
				21					



64230

SET BUSSOLE E ACCESSORI 1/4" E 1/2"

ASSORTIMENTO 94 PCS. BUSSOLE ED ACCESSORI 1/4" E 1/2" IN VALIGETTA ANTI-URTO
 94 PCS. 1/4" AND 1/2" SOCKETS AND ACCESSORIES SET IN SHOCK-PROOF CASE

94
pcs.

COD. **64230026**
€ 148,000



380 X 290 X 80 mm



	4	5,5	6,5				
	PH1	PH2					
	PZ1	PZ2					
	TX8	TX10	TX15	TX20	TX25	TX30	
	3	4	5	6			
	8	10	12				
	PH3	PH4					
	PZ3	PZ4					
	TX40	TX45	TX50	TX55			
	8	10	12	14			
	4	4,5	5	5,5	6	7	
	8	9	10	11	12	13	
	14						
	10	11	12	13	14	15	
	16	17	18	19	20	21	
	22	23	24	27	30	32	
	6	7	8	9	10	11	
	12	13					
	14	15	17	19			
candele / spark plug						16	21
		50	100				
		125	250				
flexible							
						1,5	
						2	
						2,5	

3



3 BUSSOLE E ACCESSORI

SOCKETS AND ACCESSORIES

64230

SET BUSSOLE, ACCESSORI E INSERTI 1/4" - 1/2"

ASSORTIMENTO 108 PCS. BUSSOLE ED ACCESSORI 1/4" E 1/2" IN VALIGETTA ANTI-URTO
 108 SOCKETS AND ACCESSORIES 1/4" AND 1/2" SET IN SHOCK-PROOF CASE

108 pcs.

COD. **64230030**

€ 154,291



380 X 290 X 80 mm



	4	5,5	6,5				
	PH1	PH2					
	PZ1	PZ2					
	TX8	TX10	TX15	TX20	TX25	TX27	TX30
	3	4	5	6			

	8	10	12				
	PH3	PH4					
	PZ3	PZ4					
	TX40	TX45	TX50	TX55	TX60		
	7	8	10	12	14		

	4	4,5	5	5,5	6	7
	8	9	10	11	12	13
	14					
	10	11	12	13	14	15
	16	17	18	19	20	21
	22	24	27	30	32	

	6	7	8	9	10	11	
	12	13					
	14	15	17	19	22		
	candele / spark plug					16	21

	E4	E5	E6	E7	E8		
	E10	E11	E12	E14	E16	E18	
	E20	E24					

		50	100		
		125	250		

		1,5
		2
		2,5

--	--	--



64230

SET BUSSOLE, ACCESSORI E INSERTI 1/4" - 3/8" - 1/2"

ASSORTIMENTO 215 PCS. BUSSOLE ED ACCESSORI 1/4"-3/8"-1/2" CON CHIAVI A CRICCHETTO
215 SOCKETS AND ACCESSORIES 1/4"-3/8"-1/2" SET WITH RATCHET WRENCHES

COD. **64230045**

€ 305,760

215 pcs.



450 X 350 X 90 mm



cricchetto
ratchet

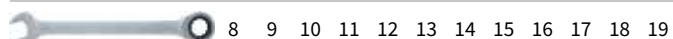

		4,0	5,5	6,5	7,0				
		PH1	PH1	PH2	PH3				
		PZ1	PZ1	PZ2	PZ3				
		THX8	THX10	THX15	THX20	THX25	THX27	THX30	
		THX40	THX45						
		2	2,5	3	4	5	6	7	
		1	2	3	4				
		6	8	10					
		5	6	8	10	12			
		4	6	8	10				
		6,0	6,5	8,0					
		PH3	PH4						
		PZ3	PZ4						
		TX27	TX30	TX35	TX40	TX45	TX50		
		TX27	TX30	TX35	TX40	TX45	TX50		
		TXH27	TXH30	TXH35	TXH40	TXH45	TXH50		
		5,5	6	6,5	7	8	10	12	
		5	6	8	10				
		4,0	5,5	6,5	7,0				
		PH0	PH1	PH2					
		PZ0	PZ1	PZ2					
		TX8	TX9	TX10	TX15	TX20	TX25	TX27	
		TX30							
		TXH8	TXH9	TXH10	TXH15	TXH20	TXH25	TXH27	
		TXH30							
		3	4	5	6				
		TX55		TX60	16				
		TX60	21 x 2pcs						
		4	4,5	5	5,5	6	7	8	
		9	10	11	12	13	14	16	
		10	11	12	13	14	15	16	
		17	18	19					
		13	14	15	16	17	18	19	
		20	21	22	24	27	30	32	
			4	5	6	7	8	9	10
		10	11	12	13	14	15		
		16	17	18	19	22			
			E4	E5	E6	E7	E8		
			E10	E11	E12	E14	E16	E18	
			E22	E22	E24				
				1,5	2	2,5	3	4	5



3 BUSSOLE E ACCESSORI

SOCKETS AND ACCESSORIES

64230

VALIGIA ABS ANTIURTO UTENSILI MANUALI CON BUSSOLE E ACCESSORI 1/4" 1/2"

VALIGIA 153 PCS. UTENSILI ASSORTITI PER PROFESSIONISTI
TOOL SET WITH 153 ASSORTED TOOLS FOR PROFESSIONALS

153 pcs.

SPECIALE PER MANUTENZIONE

SPECIAL FOR MAINTENANCE



470 X 360 X 150 mm





FOCUS ON



**GUSCIO ABS
ANTIURTO**



Valigetta con quattro vassoi interni, assortimento completo bussole ed accessori 1/4" e 1/2", inserti 5/16" con le impronte più indicate per il settore meccanico.

Case with four internal trays, complete assortment of bearings and accessories 1/4" and 1/2", 5/16" inserts with the most suitable imprints for the mechanical sector.

COD. **64230303**

€ 406,896

	4	4,5	5	5,5	6	7	
	8	9	10	11	12	13	
	10	13	14	15	16	17	18
	19	20	22	24	27	30	32
	8	10	11	12	13	14	15
	17	19	22				
	1,5	2	2,5		10	15	20
	3	4	5		25	27	30
	6	8	10		40	45	50
	0,6x3,5	1x5,5	1,2x6,5		50	100	
	PH1	PH2			125	250	
	PZ2						
		8	10				
		PH3	PH4				
		TXH40	TXH45	TXH50	TXH55		
		10	12	14			

	3,0	4,0	5,0	2pcs. 6,0	7,0
	PH0	2pcs. PH1	2pcs. PH2	PH3	
	PZ0	2pcs. PZ1	2pcs. PZ2	PZ3	
1/4"x25mm	TX10	TX15	TX20	TX25	TX27
	TX30				
	2,5	3	4	5	5,5
	6				
	LED		TESTER 250V		
	180mm		180mm		
	200mm		140mm		
	160mm		180mm		
	250mm		300mm		
	240mm		2 pcs		
	150mm		300gr		
	5m		310mm		
	600mm		20 pcs		



3 BUSSOLE E ACCESSORI

SOCKETS AND ACCESSORIES

64230

TROLLEY UTENSILI MANUALI CON BUSSOLE E ACCESSORI 1/4" 3/8" 1/2"

TROLLEY 179 PCS. UTENSILI ASSORTITI PER PROFESSIONISTI
TROLLEY WITH 179 ASSORTED TOOLS FOR PROFESSIONALS



179
pcs.



cricchetto
ratchet



470 X 380 X 210 mm





FOCUS ON



Valigetta con quattro vassoi interni completi di tutti gli utensili necessari al lavoro dei professionisti di tutti i settori, in un robusto trolley resistente agli urti.

Case with four internal trays complete with all the tools necessary for the work of professionals in all sectors, in a robust shock-resistant trolley.

COD. **64230304**

€ 468,048

	3,0 4,0 5,0 7,0
	PH0 PH1 PH2 PH3
	PZ0 PZ1 PZ2 PZ3
	TX8 TX9 TX10 TX15 TX20 TX25 TX27 TX30 TX40
	1,5 2 2,5 3 4 5 5,5 6 8
	4 4,5 5 5,5 6 7 8
	9 10 11 12 13
	10 11 12 13 14 15 16
	17 18 19 20 21 22 24
	8 10 11 12 13 14 17 19 22
	1,5 2 2,5 3 4 5 6 8 10
	1/4 1/4 50 100
	1/2 1/2 125 250
	1/4 1/4 40
	1/2 1/2 80
	1/4 1/4 16
	1/2 1/2 21
	1/4 1/4 3/8 1/4 1/4

	1/4 1/4 1/4		1/4
	6x75 6x100 8x150		6
	PH1x75 PH2x100		L=38mm PH2
	LED		TESTER 250V
	200mm		180mm
	160mm		10 pcs
	160mm		180mm
	160mm		300mm
	200mm		3 pcs
	5 pcs		300gr
	5m		200mm
	200mm		50 pcs



3 BUSSOLE E ACCESSORI

SOCKETS AND ACCESSORIES

64230

VALIGIA UTENSILI MANUALI CON BUSSOLE E ACCESSORI 1/4" 1/2"

VALIGIA 127 PCS. BUSSOLE E UTENSILI ASSORTITI
TOOL CASE WITH 127 ASSORTED TOOLS



127 pcs.

COD. 64230299

€ 263,424

470 X 360 X 150 mm



	3	4	5	6	6	7	
	PH0	PH1	PH1	PH2	PH2	PH3	
	PZ0	PZ1	PZ1	PZ2	PZ2	PZ3	
	TX10	TX15	TX20	TX25	TX27	TX30	
	2,5	3	4	5	5,5	6	
	4	4,5	5	5,5	6	7	8
	9	10	11	12	13	14	
	10	13	14	16	17	18	19
	20	22	24	27	30	32	
			40				100
			73				125 250
							16
							21
	3x75	4x100					
	PH0x75	PH2x100					
	300gr		150mm				
	3m						
	180mm		10pcs				
	200mm		140mm				
	160mm		180mm				
	200mm		200mm				
			1,5 2 2,5 3 4				
			5 6 8 10				
	8 10 11 12 13 15 17 19						
	50pcs		6pcs				
	TESTER 250V		300mm				



64230

VALIGETTA UTENSILI MANUALI CON BUSSOLE E ACCESSORI 1/4" 1/2"

ASSORTIMENTO 89 PCS BUSSOLE ED ACCESSORI 1/4", 1/2" VALIGETTA IN TERMOFORMATO
 89 PCS 1/4"-1/2" SOCKETS AND ACCESSORIES SET IN BLOW MOLD CASE



89 pcs.

440 X 350 X 100 mm



COD. **64230320**

€ 156,878

	3,0	4,5	5,0	6,0	7,0		
	PH1	PH2	PH3				
	PZ1	PZ2	PZ3				
	TX10	TX15	TX20	TX25	TX27	TX30	TX40
	TXH15	TXH20	TXH25	TXH30			
	1,5	2	2,5	3	4	5	6 8
		4	4,5	5	5,5	6	7 8
		9	10	11	12	13	14
		15	16	17	18	19	20 21
		22	24	27			
	1,5	2	2,5			8	10 12
	3	4	5			13	14 15
	6	8	10			17	
				140mm			130mm
				160mm			160mm
				200mm			180mm
				250mm			TESTER 250V
				3m			200gr
		3	6				
		PH1	PH2				

3



3 BUSSOLE E ACCESSORI

SOCKETS AND ACCESSORIES

64230

VALIGETTA A TENUTA STAGNA BUSSOLE E ACCESSORI 1/4" 3/8"

ASSORTIMENTO 82 PCS BUSSOLE ED ACCESSORI 1/4" 3/8" VALIGIA A TENUTA STAGNA
82 PCS 1/4" 3/8" SOCKETS AND ACCESSORIES SET IN WATERPROOF CASE

82 pcs.

WATERPROOF

COD. **64230322**

€ 288,736



460 X 360 X 180 mm



	4	4,5	5	5,5	6	7	8
	9						
	10	11	12	13	14	15	17
	18	19					
	160mm					3pcs	
	160mm					180mm	
	250mm					TESTER 250V	
	5m					200gr	
	3,0	4,0	2pcs. 6,0		7,0		
	PH0	2pcs. PH1	2pcs. PH2	2pcs. PH3			
	PZ0	2pcs. PZ1	2pcs. PZ2	PZ3			
	TX10	TX15	TX20	TX25	TX27	TX30	
	2,5	3	4	5	5,5	6	
	1,5	2	2,5				6x7 8x9
	3	4	5				10x11 12x13
	6	8	10				14x15 16x17
						21	
			3	5			
	PH1 PH2						





Le conoscenze maturate con gli utensili per avvitatori ci permettono di offrire anche una gamma base di utensili manuali di alta qualità. Una gamma base di tipologie usate in operazioni di avvitatura, corredate di assortimenti e confezioni dedicati all'esposizione in punto vendita.

The knowledge gained from the production of tools for screwdrivers allows us to offer a basic range of high-quality hand tools to complement the range offered in the previous chapters, and the range of tips used in screwing operations, equipped with different collections and packaging for store displays.

4

UTENSILI MANUALI HAND TOOLS



GIRAVITE
SCREWDRIVERS

p. 402



GIRAVITI 1000V VDE
1000V VDE SCREWDRIVERS

p. 410



5 IN 1

5 IN 1
5 IN 1

p. 418



5 IN 1 NANO

5 IN 1 NANO
5 IN 1 NANO

p. 419



GIRAVITE A CRICCHETTO
RATCHET SCREWDRIVERS

p. 420



**LAME DOPPIE
DI PRECISIONE**
DOUBLE PRECISION
SCREWDRIVER BLADE

p. 424



CHIAVI PER CENTRALINE
WRENCHES FOR CONTROL
UNITS

p. 426



PUNZONI
PUNCHES

p. 427



CHIAVI MASCHIO
MALE WRENCHES

p. 428



**SET PIEGHEVOLI CHIAVI
MASCHIO**
FOLDING SET MALE
WRENCHES

p. 440



**CHIAVI MASCHIO
IMPUGNATURA A "T"**
MALE WRENCHES WITH
T-SHAPED HANDLE

p. 442



CHIAVI A TRE TESTE
3 WAY MALE WRENCHES

p. 446



CHIAVI COMBinate
COMBINATION WRENCHES

p. 448



CHIAVI A CRICCHETTO
RATCHET WRENCHES

p. 452



**CHIAVI A CRICCHETTO
E SNODO**
RATCHET AND JOINTED
WRENCHES

p. 454



CHIAVI COLORATE
COLOUR SERIES WRENCHES

p. 456



CHIAVE PER PONTEGGI
WRENCHES FOR
SCAFFOLDING

p. 456



**ASSORTIMENTO UTENSILI
MANUALI**
HAND TOOLS SET

p. 457



**CONTENITORI
PORTA-UTENSILI**
TOOL CONTAINERS

p. 461



4 UTENSILI MANUALI MANUAL TOOLS

65001

GIRAVITE A TAGLIO

GIRAVITE LAMA A TAGLIO MANICO IN BICOMPONENTE
SLOTTED SCREWDRIVERS WITH BICOMPONENT HANDLE

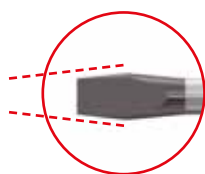

EASYPACK | scatola di cartone - cardboard box

Ø mm	L mm	PCS.	COD.	€ cad./each	
0,5	3	75	6	65001005	3,158
	3	100	6	65001007	3,909
0,8	4	100	6	65001010	3,909
	4	125	6	65001012	4,906
1	5,5	125	6	65001015	4,726
	5,5	150	6	65001017	5,768
1,2	6,5	150	6	65001020	5,768
	8	150	6	65001025	7,806
	8	200	6	65001027	9,307

Ø mm	COD.	€ box	
0,5	3	65001005001	4,659
	3	65001007001	5,398
0,8	4	65001010001	5,398
	4	65001012001	6,406
1	5,5	65001015001	6,227
	5,5	65001017001	7,269
1,2	6,5	65001020001	7,269
	8	65001025001	9,307
	8	65001027001	10,808



SELPACK
1 pc.

65001

GIRAVITE NANO A TAGLIO

GIRAVITE NANO LAMA A TAGLIO MANICO IN BICOMPONENTE
STUBBY SLOTTED SCREWDRIVER WITH BICOMPONENT HANDLE



EASYPACK | scatola di cartone - cardboard box

Ø mm	L mm	PCS.	COD.	€ cad./each	
1,2	6,5	38	6	65001120	3,752



SELPACK
1 pc.

Ø mm	COD.	€ box	
1,2	6,5	65001120001	5,253



FOCUS ON



Testa del manico semisferica per maggior comfort. Profilo impugnatura ergonomico per miglior presa e trasmissione della forza. 2 materiali: antiscivolo e resistente.

Hemispherical head handle for greater comfort. Ergonomic handle for better grip and transmission of the force. 2 materials: nonslip and resistant.



65002

GIRAVITE A TAGLIO

GIRAVITE LAMA DRITTA A TAGLIO MANICO IN BICOMPONENTE
STRAIGHT SLOTTED SCREWDRIVER WITH BICOMPONENT HANDLE

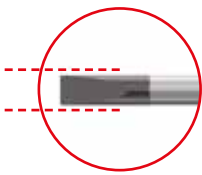
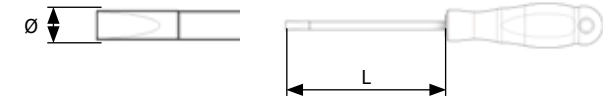

EASYPACK | scatola di cartone - cardboard box

	Ø mm	L mm	PCS.	COD.	€ cad./each
0,5	3	75	6	65002005	3,382
0,6	3,5	200	6	65002207	7,706
0,8	4	100	6	65002010	4,054
0,8	4	300	6	65002210	8,826
0,8	5	125	6	65002015	5,040
1	5	200	6	65002218	8,613
1	6	150	6	65002020	5,678
1,2	8	300	6	65002225	14,000



SELPACK
1 pc.

	Ø mm	COD.	€ box
0,5	3	65002005001	4,883
0,8	4	65002010001	5,555
0,8	5	65002015001	6,541
1	6	65002020001	7,168



4 UTENSILI MANUALI MANUAL TOOLS

65003

GIRAVITE A CROCE PH

GIRAVITE LAMA A CROCE PHILLIPS® MANICO IN BICOMPONENTE

PHILLIPS® SCREWDRIVER WITH BICOMPONENT HANDLE



EASYPACK | scatola di cartone - cardboard box

+	L mm	Ø mm	PCS.	COD.	€ cad./each
PH0	75	3	6	65003005	3,517
	100	3	6	65003007	4,043
PH1	80	5	6	65003010	4,245
	125	5	6	65003013	5,443
PH2	300	5	6	65003210	8,299
	100	6	6	65003015	5,174
PH3	150	6	6	65003018	6,440
	300	6	6	65003215	9,486
	150	8	6	65003020	8,646

+	Ø mm	COD.	€ box
PH0	3	65003005001	5,018
	3	65003007001	5,544
PH1	5	65003010001	5,746
	5	65003013001	6,944
PH2	6	65003015001	6,675
	6	65003018001	7,941
PH3	8	65003020001	10,147



SELPACK
1 pc.

65003

GIRAVITE NANO A CROCE PH

GIRAVITE NANO LAMA A CROCE PHILLIPS® MANICO IN BICOMPONENTE

PHILLIPS® STUBBY SCREWDRIVER WITH BICOMPONENT HANDLE



EASYPACK | scatola di cartone - cardboard box

+	L mm	Ø mm	PCS.	COD.	€ cad./each
PH1	38	5	6	65003110	4,099
PH2	38	6	6	65003115	4,155



SELPACK
1 pc.

+	COD.	€ box
PH1	65003110001	5,600
PH2	65003115001	5,656



65004

GIRAVITE A CROCE PZ

GIRAVITE LAMA A CROCE POZIDRIV® MANICO IN BICOMPONENTE
POZIDRIV® SCREWDRIVER WITH BICOMPONENT HANDLE

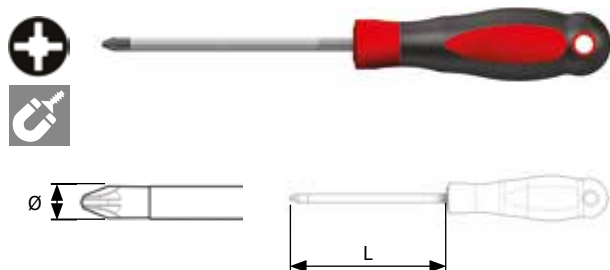

EASYPACK | scatola di cartone - cardboard box

+	L mm	Ø mm	PCS.	COD.	€ cad./each
PZ0	75	3	6	65004005	3,517
PZ1	80	5	6	65004010	4,245
PZ2	100	6	6	65004015	5,174
PZ3	150	8	6	65004020	8,646

+	Ø mm	COD.	€ box
PZ0	3	65004005001	5,018
PZ1	5	65004010001	5,746
PZ2	6	65004015001	6,675
PZ3	8	65004020001	10,147

SELFPACK
1 pc.

65005

GIRAVITE IMPRONTA TX

GIRAVITE PER VITI TORX® MANICO IN BICOMPONENTE
SCREWDRIVERS FOR TORX® SCREWS WITH BICOMPONENT HANDLE

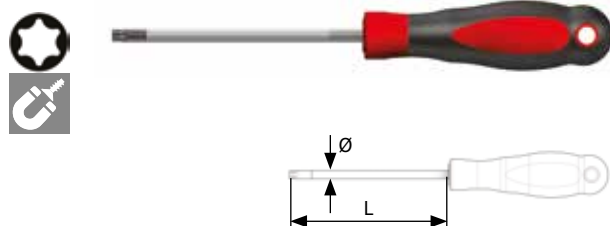

EASYPACK | scatola di cartone - cardboard box

*	L mm	Ø mm	PCS.	COD.	€ cad./each
TX5	60	3	6	65005005	3,595
TX6	60	3	6	65005010	3,595
TX7	60	3	6	65005015	3,595
TX8	60	3	6	65005020	3,595
TX9	60	4	6	65005025	3,595
TX10	80	4	6	65005029	3,562
	250	4	6	65005229	9,005
TX15	80	4	6	65005034	4,200
	250	4	6	65005234	9,005
TX20	100	4	6	65005039	4,368
	250	4	6	65005239	9,005
TX25	100	5	6	65005044	5,186
	250	5	6	65005244	9,005
TX30	100	6	6	65005054	5,264
	250	6	6	65005254	9,005
TX40	125	8	6	65005059	8,512

*	COD.	€ box
TX5	65005005001	5,085
TX6	65005010001	5,085
TX7	65005015001	5,085
TX8	65005020001	5,085
TX9	65005025001	5,085
TX10	65005029001	4,995
TX15	65005034001	5,712
TX20	65005039001	5,880
TX25	65005044001	6,720
TX30	65005054001	6,866
TX40	65005059001	10,147

SELFPACK
1 pc.



4 UTENSILI MANUALI MANUAL TOOLS

65005

GIRAVITE IMPRONTA TXH

GIRAVITE PER VITI TORX® ANTI-MANOMISSIONE MANICO IN BICOMPONENTE
SCREWDRIVERS FOR TORX® TAMPER RESISTANT SCREWS WITH BICOMPONENT HANDLE



EASYPACK | scatola di cartone - cardboard box

	L mm	Ø mm	PCS.	COD.	€ cad./each
TXH10	80	4	6	65005030	3,674
TXH15	80	4	6	65005035	4,323
TXH20	100	4	6	65005040	4,458
TXH25	100	5	6	65005045	5,298
TXH27	100	5	6	65005050	5,298
TXH30	100	6	6	65005055	5,432
TXH40	125	8	6	65005060	8,669



	COD.	€ box
TXH10	65005030001	5,174
TXH15	65005035001	5,824
TXH20	65005040001	5,958
TXH25	65005045001	6,798
TXH27	65005050001	6,798
TXH30	65005055001	6,933
TXH40	65005060001	10,170



SELPACK
1 pc.



Dettaglio di una casa in costruzione.
A house under construction.



4 UTENSILI MANUALI MANUAL TOOLS

65006

ASSORTIMENTI GIRAVITE

ASSORTIMENTI 6 PCS. GIRAVITE
6 PCS. SCREWDRIVERS SETS



160 X 290 X 35 mm

6
pcs.

COD. **65006005**

€ 27,132

65003		65004		65001	
PH1x80	PH2x100	PZ1x80	PZ2x100	4,0x100	6,5x150
1pc.	1pc.	1pc.	1pc.	1pc.	1pc.

COD. **65006010**

€ 25,642

65004		65001			
PZ1x80	PZ2x100	3,0x75	4,0x100	5,5x125	6,5x150
1pc.	1pc.	1pc.	1pc.	1pc.	1pc.

COD. **65006020**

€ 29,579

65005					
TX10x80	TX15x80	TX20x100	TX25x100	TX30x100	TX40x125
1pc.	1pc.	1pc.	1pc.	1pc.	1pc.

COD. **65006015**

€ 26,174

65003		65002			
PH1x80	PH2x100	4,0x100	5,0x125	6,0x150	
1pc.	1pc.	1pc.	1pc.	1pc.	

INCLUSO
INCLUDED

COD. 65999001



TIPS



Magnetizzatore/smagnetizzatore COD. 65011005 p. 233
Magnetiser/demagnetiser COD. 65011005 p. 233



Bussola magnetica per GIRAVITE fino COD. 65011010 p. 234
Magnetic socket for screwdrivers up to COD. 65011010 p. 234



65007

ESPOSITORE GIRAVITE

ESPOSITORE DA BANCO GIRAVITE
COUNTER DISPLAY FOR SCREWDRIVERS







144
pcs.

450 X 320 X 200 mm



COD. **65007005**

€ 626,226

65003 			65004 		
PH0x75 12pcs.	PH1x80 12pcs.	PH2x100 12pcs.	PZ0x75 12pcs.	PZ1x80 12pcs.	PZ2x100 12pcs.
65001 					65002 
3,0x75 12pcs.	4,0x100 12pcs.	5,5x125 12pcs.	6,5x150 12pcs.	8,0x200 12pcs.	5,0x125 12pcs.

COD. **65007010**

€ 589,389

65005 						
TX5x60 12pcs.	TX6x60 12pcs.	TX7x60 12pcs.	TX8x60 12pcs.	TX9x60 12pcs.		
65005 						
TX10 x80 12pcs.	TX15 x80 12pcs.	TX20 x100 12pcs.	TX25 x100 12pcs.	TX27 x100 12pcs.	TX30 x100 12pcs.	TX40 x125 12pcs.

4



4 UTENSILI MANUALI MANUAL TOOLS

65022

GIRAVITE ISOLATO 1000V VDE A TAGLIO

GIRAVITE 1000V VDE LAMA A TAGLIO MANICO IN BICOMPONENTE

1000V VDE SLOTTED SCREWDRIVERS WITH BICOMPONENT HANDLE

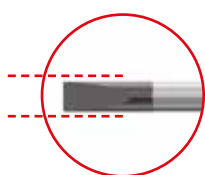

EASYPACK | scatola di cartone - cardboard box

Ø mm	L mm	PCS.	COD.	€ cad./each	
0,4	2,5	75	6	65022003	4,704
0,8	4	100	6	65022010	5,376
1,0	5,5	125	6	65022015	5,936
1,2	6,5	150	6	65022020	6,608
1,2	8	175	6	65022025	10,528

Ø mm	COD.	€ cad./each	
0,4	2,5	65022003001	6,165
0,8	4	65022010001	6,912
1,0	5,5	65022015001	7,409
1,2	6,5	65022020001	8,088
1,2	8	65022025001	12,047



SELPACK
1 pc.

65023

GIRAVITE ISOLATO 1000V VDE A CROCE PHILLIPS®

GIRAVITE 1000V VDE LAMA A CROCE PHILLIPS® MANICO IN BICOMPONENTE

1000V VDE PHILLIPS® SCREWDRIVER WITH BICOMPONENT HANDLE



EASYPACK | scatola di cartone - cardboard box

Ø mm	L mm	PCS.	COD.	€ cad./each	
PH0	3	75	6	65023005	3,920
PH1	4,5	80	6	65023010	4,704
PH2	6	100	6	65023015	5,936

Ø mm	COD.	€ cad./each	
PH0	3	65023005001	5,426
PH1	4,5	65023010001	6,226
PH2	6	65023015001	7,409



SELPACK
1 pc.



65024

GIRAVITE ISOLATO 1000V VDE A CROCE POZIDRIV®

GIRAVITE 1000V VDE LAMA A CROCE POZIDRIV® MANICO IN BICOMPONENTE

1000V VDE POZIDRIV® SCREWDRIVER WITH BICOMPONENT HANDLE

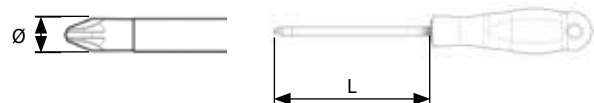

EASYPACK | scatola di cartone - cardboard box

	Ø mm	L mm	PCS.	COD.	€ cad./each
PZ1	4,5	80	6	65024010	4,704
PZ2	6	100	6	65024015	5,936
PZ3	8	150	6	65024020	10,416



	Ø mm	COD.	€ cad./each
PZ1	4,5	65024010001	6,226
PZ2	6	65024015001	7,409
PZ3	8	65024020001	11,934

SELPACK
1 pc.

65999

CERCAFASE

GIRAVITE CERCAFASE

TESTER

250 V

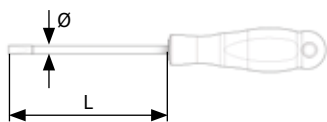

EASYPACK | scatola di cartone - cardboard box

	Ø mm	L mm	PCS.	COD.	€ cad./each
0,6	3	60	6	65999001	3,864



4 UTENSILI MANUALI MANUAL TOOLS

65026

ASSORTIMENTI GIRAVITE ISOLATO 1000V VDE

ASSORTIMENTI 5-6 PCS. GIRAVITE 1000V VDE

5-6 PCS. 1000V VDE SCREWDRIVERS SETS







160 X 290 X 35 mm

5
pcs.





COD. **65026005**

€ 25,004

65023 	65022 
	
PH1x100 1pc.	PH2x100 1pc.
2,5x75 1pc.	4,0x100 1pc.
5,5x125 1pc.	

COD. **65026010**





€ 25,004

65024 	65022 
	
PZ1x100 1pc.	PZ2x100 1pc.
2,5x75 1pc.	4,0x100 1pc.
5,5x125 1pc.	

6
pcs.

COD. **65026015**

€ 29,792

65023 	65022 
	
PH0x75 1pc.	PH1x100 1pc.
PH2x100 1pc.	2,5x75 1pc.
4,0x100 1pc.	5,5x125 1pc.



65006

ASSORTIMENTI LAME 1000V VDE INTERCAMBIABILI

ASSORTIMENTO 9 PCS. LAME 1000V VDE INTERCAMBIABILI CON IMPUGNATURA

9
pcs.

COD. **65006185**

€ 52,080



				●		
0,4x2,5 1pc.	0,6x3,5 1pc.	1,0x5,5 1pc.	1,2x6,5 1pc.	PH0 1pc.	PH1 1pc.	PH2 1pc.

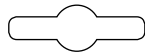
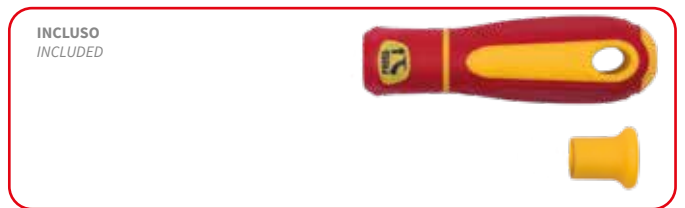

EURO-HOLE

105 X 47 X 220 mm





4 UTENSILI MANUALI MANUAL TOOLS

65006

ASSORTIMENTI LAME 1000V VDE INTERCAMBIABILI

ASSORTIMENTO 18 PCS. LAME 1000V VDE INTERCAMBIABILI CON IMPUGNATURA
18 PIECE ASSORTMENT BLADE 1000V VDE INTERCHANGEABLE WITH HANDLE ASSORTMENT

18
pcs.

COD. **65006190**

€ 81,200



		-		+		+	
3,0 1pc.	4,0 1pc.	5,5 1pc.	6,5 1pc.	PH1 1pc.	PH2 1pc.	PZ1 1pc.	PZ2 1pc.
+		+		○	△	□	
PH1 1pc.	PH2 1pc.	PZ1 1pc.	PZ2 1pc.	5,3 1pc.	9 1pc.	6 1pc.	8 1pc.

INCLUSO
INCLUDED



EURO-HOLE

120 X 65 X 220 mm



FOCUS ON



Quattro chiavi con le impronte più comuni per aprire le cassette ed i quadri elettrici e lavorare in tutta sicurezza.

Four keys with the most common prints required to open boxes and the electrical panels and work in complete safety.



65007

ESPOSITORE GIRAVITE ISOLATO 1000V VDE

ESPOSITORE DA BANCO GIRAVITE 1000V VDE
COUNTER DISPLAY FOR 1000V VDE SCREWDRIVERS









144
pcs.



450 X 320 X 200 mm

COD. **65007015**

€ 789,578

<p>65023 </p> 			<p>65024 </p> 		
PH0x75 12pcs.	PH1x80 12pcs.	PH2x100 12pcs.	PZ1X80 12pcs.	PZ2X100 12pcs.	PZ3X150 12pcs.
<p>65022 </p> 					<p>65999 </p> 
2,5X75 12pcs.	4,0x100 12pcs.	5,5x125 12pcs.	6,5x150 12pcs.	8,0x175 12pcs.	250 V 12pcs.



4 UTENSILI MANUALI MANUAL TOOLS

64230

SET BUSSOLE E ACCESSORI VDE 1/2"

ASSORTIMENTO 11 PCS. BUSSOLE ED ACCESSORI 1/2" VDE IN VALIGETTA ANTI-URTO
11 PCS. 1/2" VDE SOCKETS AND ACCESSORIES SET IN SHOCK-PROOF CASE



11
pcs.

COD. **64230615**

€ 325,455

10	12	13	14	17	19	22	24
1 pc.	1 pc.	1 pc.	1 pc.	1 pc.	1 pc.	1 pc.	1 pc.
125 mm							
230 mm							
205 mm							

64230

VALIGETTA UTENSILI MANUALI BUSSOLE E ACCESSORI 3/8" VDE

**ASSORTIMENTO 25 PCS. UTENSILI MANUALI, BUSSOLE ED ACCESSORI 3/8" VDE
IN VALIGETTA ANTI-URTO**
25 PCS. VDE HAND TOOLS, 3/8" SOCKETS AND ACCESSORIES SET IN SHOCK-PROOF CASE



25
pcs.

COD. **64230630**

€ 540,000

7	8	10	12	13	15	17	19	22
1 pc.	1 pc.	1 pc.	1 pc.	1 pc.	1 pc.	1 pc.	1 pc.	1 pc.
7	8	10	12	13	17			
1 pc.	1 pc.	1 pc.	1 pc.	1 pc.	1 pc.			
PH1x100 1 pc.			PH2x100 1 pc.			0,8x4x100 1 pc.		
			100 mm			190 mm		
			205 mm			195 mm		
180 mm						160 mm		



GIRAVITI 1000V VDE 1000V VDE SCREWDRIVERS

FOCUS ON

Linea completa di giraviti testati:

- 1 Certificati secondo la normativa tedesca VDE.
- 2 Impugnatura ergonomica in bi-componente per una presa confortevole.
- 3 Lama in acciaio CrMoV di alta qualità.
- 4 Punta magnetica.

Complete line of tested screwdrivers:

- 1 Certificates according to the German VDE regulation.
- 2 Ergonomic bi-component handle for a comfortable grip.
- 3 High quality CrMoV steel blade.
- 4 Magnetic tip.



4

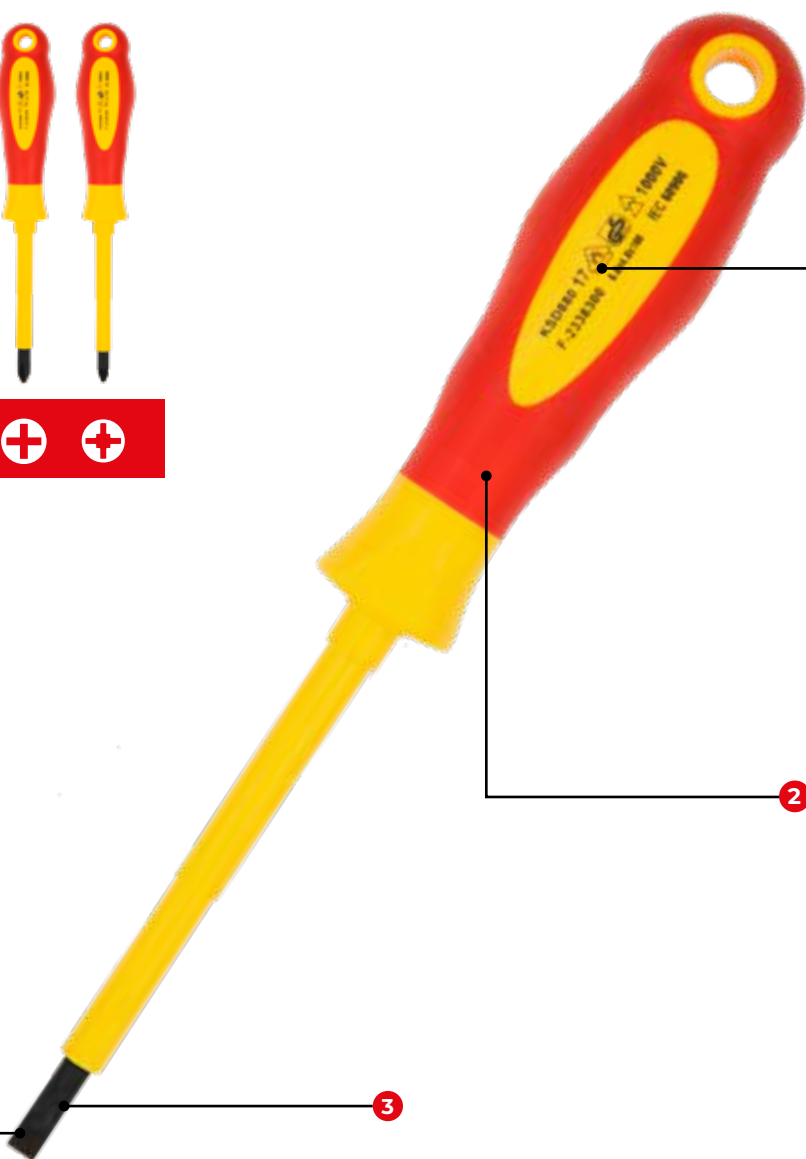

1

2

3





4 UTENSILI MANUALI MANUAL TOOLS

65006

5 IN 1

GIRAVITE 5 IN 1 CON LAMA DOPPIA ESTRAIBILE PUNTA MAGNETICA 5 IN 1 SCREWDRIVERS WITH DOUBLE EXTRACTABLE BLADE MAGNETIC TIP

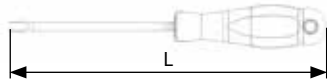

EASYPACK | scatola di cartone - cardboard box

L mm	PCS.	COD.	€ cad./each
212	6	65006036	9,173



PH0	+	PH1	+	PH2	+	PH3		1x6
-----	---	-----	---	-----	---	-----	--	-----



FOCUS ON

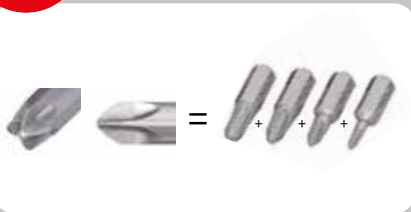

La particolare forma dell'impronta permette a questo giravite di adattarsi facilmente alle diverse misure di vite PHILLIPS® (da PH0 a PH3).

The particular shape of the tip allows this screwdriver to adapt easily to the different sizes of the PHILLIPS® screws (from PH0 to PH3).

65006

DISPLAY 5 IN 1

ESPOSITORE DA BANCO PER 12 PCS. COUNTER DISPLAY FOR 12 PCS.



12
pcs.



COD. **65006035**

€ **110,544**

12 pcs.
COD. 65006036

180 X 280 X 140 mm



65006

5 IN 1 NANO

GIRAVITE 5 IN 1 CON LAMA DOPPIA ESTRAIBILE PUNTA MAGNETICA
5 IN 1 SCREWDRIVERS WITH DOUBLE EXTRACTABLE BLADE MAGNETIC TIP

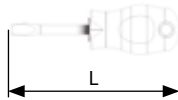

EASYPACK | scatola di cartone - cardboard box

L mm	PCS.	COD.	€ cad./each
92	6	65006031	7,291



PH0	+	PH1	+	PH2	+	PH3		1x6
-----	---	-----	---	-----	---	-----	--	-----

65006

DISPLAY 5 IN 1 NANO

ESPOSITORE DA BANCO PER 12 PCS.
COUNTER DISPLAY FOR 12 PCS.



180 X 175 X 140 mm

12
pcs.

COD. **65006030**

€ 88,200



12 pcs.
COD. 65006031



4 UTENSILI MANUALI MANUAL TOOLS

65006

CRICCHETTO NANO CON 6 INSERTI

GIRAVITE A CRICCHETTO REVERSIBILE CON 6 INSERTI 1/4"
REVERSIBLE RATCHET SCREWDRIVER WITH 6 1/4" BITS

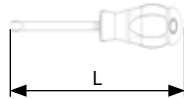

L mm	PCS.	COD.	€ cad./each
135	6	65006046	8,317



25mm PH1	25mm PH2	25mm PZ1	25mm PZ2	25mm 6,0	25mm 7,0
1pc.	1pc.	1pc.	1pc.	1pc.	1pc.

65006

DISPLAY CRICCHETTO NANO

ESPOSITORE DA BANCO 12 GIRAVITE A CRICCHETTO
COUNTER DISPLAY FOR 12 RATCHET SCREWDRIVERS



200 X 230 X 155 mm

12
pcs.

COD. **65006045**
€ 99,680



12 pcs.
COD. 65006046

**64221**

CRICCHETTO REVERSIBILE FINGER-TWIST

SET 6 PCS. CRICCHETTO DA PALMO REVERSIBILE CON INSERTI
6 PCS FINGER-TWIST RATCHET SET WITH BITS

**6 pcs.**COD. **64221001**

€ 17,248

PH1	PH2	PH3	5,5x1,0	7,0x1,2						
1pc.	1pc.	1pc.	1pc.	1pc.						

**65006**

GIRAVITE CRICCHETTO NANO CON 7 INSERTI 1/4" C

GIRAVITE A CRICCHETTO REVERSIBILE CON 7 INSERTI 1/4" C
REVERSIBLE RATCHET SCREWDRIVER WITH 7 PCS 1/4" C BITS

35 Nm**8 pcs.**

L mm	PCS.	COD.	€ cad./each
135	1	65006047	14,448

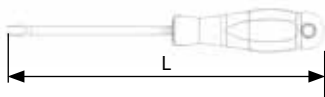

4	5	6	PH1	PH2	TX15	TX20							
1pc.	1pc.	1pc.	1pc.	1pc.	1pc.	1pc.	1pc.						



4 UTENSILI MANUALI

MANUAL TOOLS

65006

GIRAVITE CRICCHETTO CON 13 INSERTI

GIRAVITE A CRICCHETTO REVERSIBILE CON 13 INSERTI 1/4" C E PORTAINSERI
REVERSIBLE RATCHET SCREWDRIVER WITH 13 PCS 1/4" C BITS AND BIT-HOLDER

30 Nm

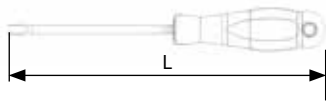

15
pcs.

L mm	PCS.	COD.	€ cad./each
175	1	65006050	20,496



 PH1 1pc.	 PH2 1pc.	 PH3 1pc.	 PZ1 1pc.	 PZ2 1pc.	 PZ3 1pc.	
 5 1pc.	 7 1pc.	 4 1pc.	 5 1pc.	 TX15 1pc.	 TX20 1pc.	 TX25 1pc.

INCLUSO
INCLUDED

COD. 62013005





Posa di impianti in una controsoffittatura.
Installation of systems in a false ceiling.



4 UTENSILI MANUALI MANUAL TOOLS

65006

ASSORTIMENTI LAME DOPPIE CON CRICCHETTO

ASSORTIMENTO 12 PCS LAME DOPPIE DI PRECISIONE CON CRICCHETTO REVERSIBILE E TELESCOPICO

12 PCS DOUBLE PRECISION SCREWDRIVER BLADE SET WITH REVERSIBLE TELESCOPIC RATCHET

COD. **65006042**

€ 46,368



2-PH00 1pc.	3-PH0 1pc.	4-PH1 1pc.	1,5-3 1pc.	2-3,5 1pc.	2,5-4 1pc.

4 1pc.	5 1pc.	5,5 1pc.	7 1pc.	8 1pc.

INCLUSO
INCLUDED



EURO-HOLE

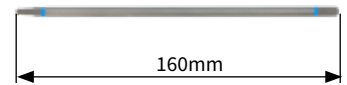

105 X 35 X 220 mm



65006

ASSORTIMENTI LAME DOPPIE CON CRICCHETTO

ASSORTIMENTO 9 PCS LAME DOPPIE CON CRICCHETTO REVERSIBILE E TELESCOPICO
9 PCS DOUBLE SCREWDRIVER BLADE SET WITH REVERSIBLE TELESCOPIC RATCHET

COD. **65006041**

€ 48,384



 PH1-PH2 1pc.	 PZ1-PZ2 1pc.	 5-5 1pc.	 6-6 1pc.
 4-6 1pc.	 5-7 1pc.	 TX20-TX25 1pc.	 TX30-TX40 1pc.

INCLUSO
INCLUDED



120 X 60 X 260 mm

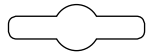

EURO-HOLE

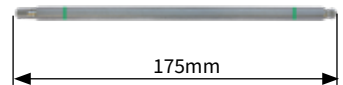



4 UTENSILI MANUALI MANUAL TOOLS

65014

CRICCHETTO UNIVERSALE PER MANDRINI A CREMAGLIERA

CRICCHETTO UNIVERSALE PER MANDRINI A CREMAGLIERA
UNIVERSAL RATCHET FOR DRILL CHUCKS WITH KEY

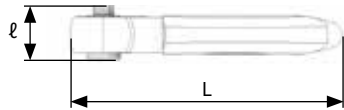

L mm

PCS.

COD.

€
cad./each

112

1

65014010

22,557



65014

CHIAVI PER CENTRALINE QUADRI CASSETTE ACQUA E GAS

CHIAVE CROMATA CON INSERTO DOPPIO ED ADATTATORE
CHROME WRENCH WITH DOUBLE BIT AND ADAPTER



EURO-HOLE



105 X 180 mm

COD. **65014001**

€ 7,634



6



8



10

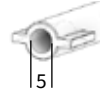

15

INCLUSO
INCLUDED



PH2



1,2x6

**65015**

PUNZONI NUMERICI E ALFABETICI

ASSORTIMENTI PUNZONI ALFABETICI E NUMERICI CARATTERI A FILO
ALPHABETICAL AND NUMERICAL PUNCHES SET WIRED CHARACTERS

**9
pcs.**

Gr.	L mm	B mm	COD.	€ cad./each
2	60	6,4	65015000	13,178
3	60	6,4	65015001	13,178
4	60	6,4	65015003	13,772
5	60	8	65015005	18,520
6	67	9,5	65015007	22,676
8	75	11,2	65015010	37,041
10	70	12,9	65015012	46,420

**27
pcs.**

Gr.	L mm	B mm	COD.	€ cad./each
2	60	6,4	65015099	39,059
3	60	6,4	65015100	39,059
4	60	6,4	65015103	41,196
5	60	8	65015105	54,849
6	67	9,5	65015107	73,963
8	75	11,2	65015110	113,734
10	70	12,9	65015112	144,720

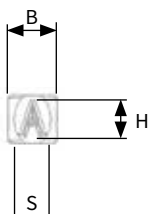
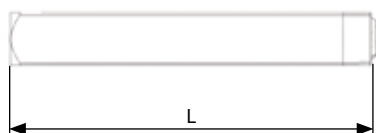
**DIMENSIONI** | dimensions

Gr.	L mm	B mm	HxS
2 (5/64")	60	6,4	2,3x1,6
3 (1/8")	60	6,4	3,2x2
4 (5/32")	60	6,4	4x2,9
5 (3/16")	60	8	4,8x3,4
6 (1/4")	67	9,5	6,3x3,8
8 (5/16")	75	11,2	7,9x5
10 (3/8")	70	12,9	9,6x6,6



4 UTENSILI MANUALI MANUAL TOOLS

65031

CHIAVI MASCHIO ESAGONO CORTE

CHIAVI MASCHIO PIEGATE ESAGONALI
HEXAGONAL MALE WRENCHES

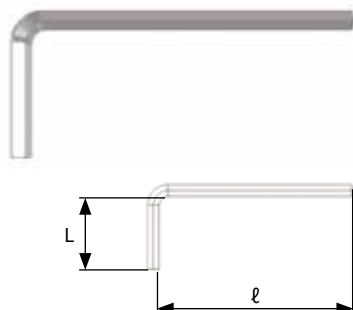

EASYPACK | sacchetto PVC con Euro-hole - PVC bags with Euro-hole

Ø	L mm	ℓ mm	PCS.	COD.	€ cad./each
1,5	11	45	10	65031005	0,235
2	15	50	10	65031010	0,258
2,5	17	55	10	65031015	0,280
3	19,5	60	10	65031020	0,347
4	23	65	10	65031025	0,381
5	26	72	10	65031030	0,806
6	32	90	10	65031035	1,030
8	36	100	10	65031040	1,445
10	40	112	10	65031045	2,274
13	50	142	10	65031060	6,675
17	80	177	10	65031080	11,122
19	89	199	10	65031090	15,568
22	100	216	10	65031110	26,768

65034

CHIAVI MASCHIO ESAGONO SFERICO CORTE

CHIAVI MASCHIO PIEGATE ESAGONALI TESTA SFERICA
BALL-HEAD HEXAGONAL MALE WRENCHES

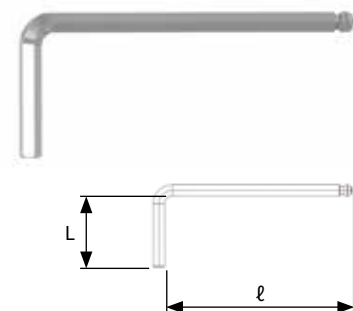

EASYPACK | sacchetto PVC con Euro-hole - PVC bags with Euro-hole

Ø	L mm	ℓ mm	PCS.	COD.	€ cad./each
1,5	11	45	10	65034005	0,336
2	15	50	10	65034010	0,370
2,5	17	55	10	65034015	0,392
3	19,5	60	10	65034020	0,459
4	23	65	10	65034025	0,538
5	26	72	10	65034030	0,986
6	32	90	10	65034035	1,210
8	36	100	10	65034040	1,669
10	40	112	10	65034045	2,430



65041

CHIAVI MASCHIO TX CORTE

CHIAVI MASCHIO PIEGATE PER VITI TORX®
MALE WRENCHES FOR TORX® SCREWS

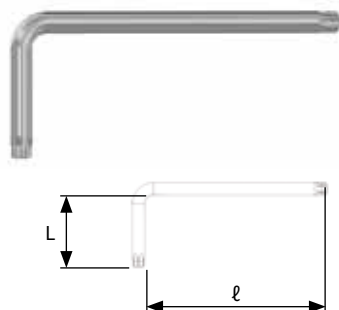

EASYPACK | sacchetto PVC con Euro-hole - PVC bags with Euro-hole

	L mm	ℓ mm	PCS.	COD.	€ cad./each
TX10	13,5	45	10	65041025	0,381
TX15	15	50	10	65041030	0,616
TX20	18	56	10	65041035	0,762
TX25	20	63	10	65041040	0,907
TX27	25	70	10	65041045	1,064
TX30	28	80	10	65041050	1,254
TX40	32	90	10	65041055	1,523
TX45	36	100	10	65041060	1,669
TX50	40	112	10	65041065	1,971

65044

CHIAVI MASCHIO TXH CORTE

CHIAVI MASCHIO PIEGATE PER VITI TORX® CON FORO
MALE WRENCHES FOR TORX® SCREWS WITH HOLE

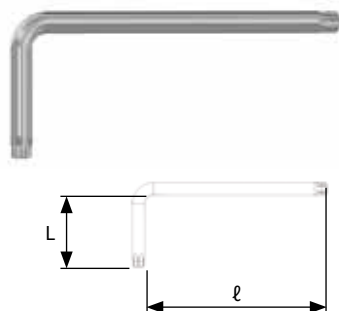

EASYPACK | sacchetto PVC con Euro-hole - PVC bags with Euro-hole

	L mm	ℓ mm	PCS.	COD.	€ cad./each
TXH10	13,5	45	10	65044025	0,381
TXH15	15	50	10	65044030	0,616
TXH20	18	56	10	65044035	0,762
TXH25	20	63	10	65044040	0,907
TXH27	25	70	10	65044045	1,064
TXH30	28	80	10	65044050	1,254
TXH40	32	90	10	65044055	1,523
TXH45	36	100	10	65044060	1,669
TXH50	40	112	10	65044065	1,971



4 UTENSILI MANUALI MANUAL TOOLS

65032

CHIAVI MASCHIO ESAGONO LUNGHE

CHIAVI MASCHIO PIEGATE ESAGONALI TIPO LUNGO

LONG HEXAGONAL MALE WRENCHES

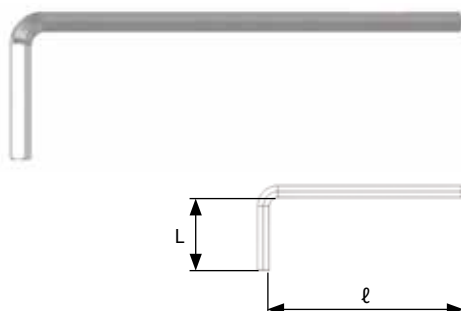

EASYPACK | sacchetto PVC con Euro-hole - PVC bags with Euro-hole

Ø	L mm	ℓ mm	PCS.	COD.	€ cad./each
1,5	14	72	10	65032005	0,190
2	15	80	10	65032010	0,213
2,5	17	86	10	65032015	0,246
3	19	94	10	65032020	0,302
4	21	102	10	65032025	0,381
5	26	115	10	65032030	0,806
6	30	134	10	65032035	1,030
8	32	152	10	65032040	1,445
10	38	170	10	65032045	2,274

65035

CHIAVI MASCHIO ESAGONO SFERICO LUNGHE

CHIAVI MASCHIO PIEGATE ESAGONALI TESTA SFERICA TIPO LUNGO

LONG BALL HEAD HEXAGONAL MALE WRENCHES

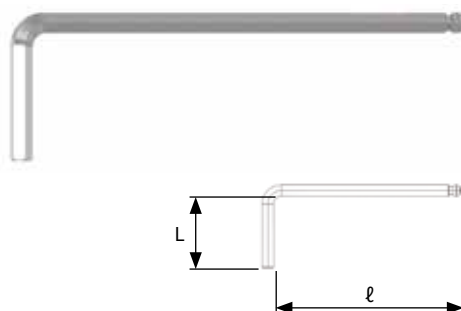

EASYPACK | sacchetto PVC con Euro-hole - PVC bags with Euro-hole

Ø	L mm	ℓ mm	PCS.	COD.	€ cad./each
1,5	14	72	10	65035005	0,336
2	15	80	10	65035010	0,370
2,5	17	86	10	65035015	0,437
3	19	94	10	65035020	0,538
4	21	102	10	65035025	0,986
5	26	115	10	65035030	1,210
6	30	134	10	65035035	1,814
8	32	152	10	65035040	2,274
10	39	170	10	65035045	3,483



65042

CHIAVI MASCHIO TX LUNGHE

CHIAVI MASCHIO PIEGATE TX TIPO LUNGO
LONG TX MALE WRENCHES

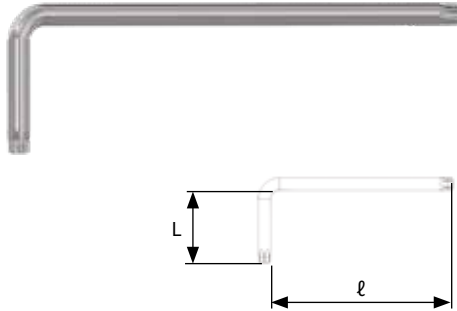

EASYPACK | sacchetto PVC con Euro-hole - PVC bags with Euro-hole

	L mm	ℓ mm	PCS.	COD.	€ cad./each
TX10	17	86	10	65042025	0,616
TX15	19	90	10	65042030	0,616
TX20	20	95	10	65042035	0,795
TX25	21	99	10	65042040	0,795
TX27	22	104	10	65042045	0,885
TX30	25	114	10	65042050	1,142
TX40	27	124	10	65042055	1,590
TX45	29	135	10	65042060	3,170
TX50	34	150	10	65042065	5,275

65045

CHIAVI MASCHIO TXH LUNGHE

CHIAVI MASCHIO PIEGATE TXH TIPO LUNGO
LONG TXH WITH HOLE MALE WRENCHES

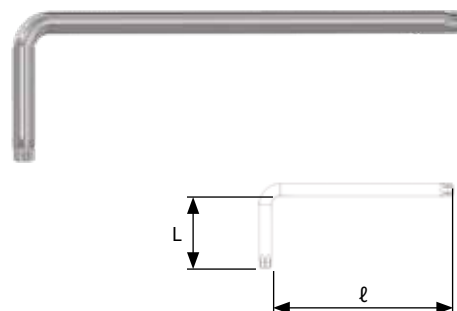

EASYPACK | sacchetto PVC con Euro-hole - PVC bags with Euro-hole

	L mm	ℓ mm	PCS.	COD.	€ cad./each
TXH10	17	86	10	65045025	0,616
TXH15	19	90	10	65045030	0,616
TXH20	20	95	10	65045035	0,795
TXH25	21	99	10	65045040	0,795
TXH27	22	104	10	65045045	0,885
TXH30	25	114	10	65045050	1,142
TXH40	27	124	10	65045055	1,590
TXH45	29	135	10	65045060	3,170
TXH50	34	150	10	65045065	5,275



4 UTENSILI MANUALI MANUAL TOOLS

65033

CHIAVI MASCHIO ESAGONO EXTRA LUNGHE

CHIAVI MASCHIO PIEGATE ESAGONALI TIPO EXTRA-LUNGO

EXTRA-LONG HEXAGONAL MALE WRENCHES

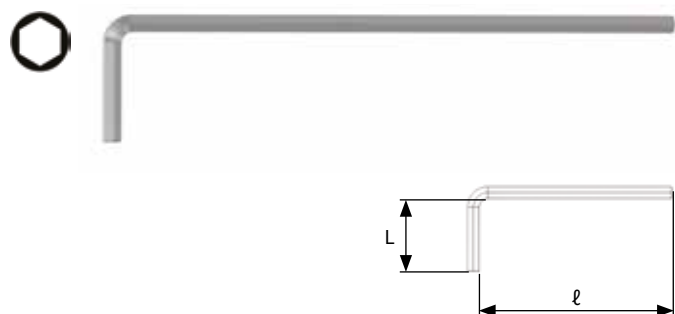

EASYPACK | sacchetto PVC con Euro-hole - PVC bags with Euro-hole

Ø	L mm	ℓ mm	PCS.	COD.	€ cad./each
1,5	14	90	10	65033005	0,414
2	16	98	10	65033010	0,482
2,5	18	110	10	65033015	0,549
3	20	125	10	65033020	0,616
4	24	138	10	65033025	0,874
5	28	157	10	65033030	1,288
6	31	178	10	65033035	2,027
8	35	196	10	65033040	2,419
10	40	220	10	65033045	3,506

65036

CHIAVI MASCHIO ESAGONO SFERICO EXTRA LUNGHE

CHIAVI MASCHIO PIEGATE ESAGONALI TESTA SFERICA TIPO EXTRA-LUNGO

EXTRA-LONG BALL HEAD HEXAGONAL MALE WRENCHES

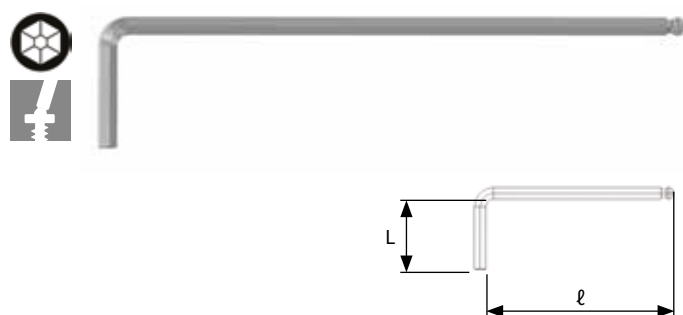

EASYPACK | sacchetto PVC con Euro-hole - PVC bags with Euro-hole

Ø	L mm	ℓ mm	PCS.	COD.	€ cad./each
1,5	14	90	10	65036005	0,616
2	16	98	10	65036010	0,683
2,5	18	110	10	65036015	0,762
3	20	125	10	65036020	0,840
4	24	138	10	65036025	1,064
5	28	157	10	65036030	1,523
6	31	178	10	65036035	2,274
8	35	196	10	65036040	2,722
10	40	220	10	65036045	4,088



65043

CHIAVI MASCHIO TX EXTRA LUNGHE

CHIAVI MASCHIO PIEGATE PER VITI TORX® TIPO EXTRA-LUNGO
EXTRA-LONG MALE WRENCHES FOR TORX® SCREWS

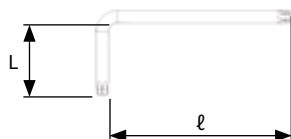

EASYPACK | sacchetto PVC con Euro-hole - PVC bags with Euro-hole

	L mm	ℓ mm	PCS.	COD.	€ cad./each
TX10	16	90	10	65043005	0,616
TX15	17	102	10	65043010	0,762
TX20	18	111	10	65043015	1,030
TX25	20	126	10	65043020	1,210
TX27	25	142	10	65043025	1,445
TX30	28	160	10	65043030	1,669
TX40	33	174	10	65043035	1,971
TX45	36	195	10	65043040	2,576
TX50	40	218	10	65043045	2,878

65046

CHIAVI MASCHIO TXH EXTRA LUNGHE

CHIAVI MASCHIO PIEGATE PER VITI TORX® CON FORO TIPO EXTRA-LUNGO
EXTRA-LONG MALE WRENCHES FOR TORX® SCREWS WITH HOLE

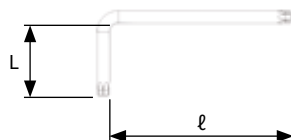

EASYPACK | sacchetto PVC con Euro-hole - PVC bags with Euro-hole

	L mm	ℓ mm	PCS.	COD.	€ cad./each
TXH10	16	90	10	65046005	0,683
TXH15	17	102	10	65046010	0,840
TXH20	18	111	10	65046015	1,030
TXH25	20	126	10	65046020	1,142
TXH27	25	142	10	65046025	1,523
TXH30	28	160	10	65046030	1,747
TXH40	33	174	10	65046035	2,050
TXH45	36	195	10	65046040	2,654
TXH50	40	218	10	65046045	3,114



4 UTENSILI MANUALI MANUAL TOOLS

65101

SET CHIAVI CORTE

SERIE 9 PCS. CHIAVI MASCHIO PIEGATE
SERIES 9 MALE WRENCHES



9
pcs.



EURO-HOLE

950 X 180 mm

COD. **65101001**

€ 7,670

65031 

1,5	2	2,5	3	4	5	6	8	10
1pc.	1pc.	1pc.	1pc.	1pc.	1pc.	1pc.	1pc.	1pc.

COD. **65101011**

€ 8,149

65034 

1,5	2	2,5	3	4	5	6	8	10
1pc.	1pc.	1pc.	1pc.	1pc.	1pc.	1pc.	1pc.	1pc.

COD. **65101031**

€ 8,269

65041 

TX10	TX15	TX20	TX25	TX27	TX30	TX40	TX45	TX50
1pc.	1pc.	1pc.	1pc.	1pc.	1pc.	1pc.	1pc.	1pc.

COD. **65101041**

€ 9,108

65044 

TXH10	TXH15	TXH20	TXH25	TXH27	TXH30	TXH40	TXH45	TXH50
1pc.	1pc.	1pc.	1pc.	1pc.	1pc.	1pc.	1pc.	1pc.



65101

SET CHIAVI LUNGHE

SET 9 PCS CHIAVI MASCHIO PIEGATE TIPO LUNGO
9 PCS LONG MALE WRENCHES SET



9
pcs.

COD. **65101002**

€ 9,108

65032

1,5	2	2,5	3	4	5	6	8	10
1pc.	1pc.	1pc.	1pc.	1pc.	1pc.	1pc.	1pc.	1pc.

COD. **65101012**

€ 9,827

65035

1,5	2	2,5	3	4	5	6	8	10
1pc.	1pc.	1pc.	1pc.	1pc.	1pc.	1pc.	1pc.	1pc.

COD. **65101032**

€ 10,546

65042

TX10	TX15	TX20	TX25	TX27	TX30	TX40	TX45	TX50
1pc.	1pc.	1pc.	1pc.	1pc.	1pc.	1pc.	1pc.	1pc.

COD. **65101042**

€ 11,744

65045

TXH10	TXH15	TXH20	TXH25	TXH27	TXH30	TXH40	TXH45	TXH50
1pc.	1pc.	1pc.	1pc.	1pc.	1pc.	1pc.	1pc.	1pc.



EURO-HOLE



4 UTENSILI MANUALI MANUAL TOOLS

65101

SET CHIAVI MASCHIO TIPO LUNGO

SERIE 8 PCS. CHIAVI MASCHIO PIEGATE IN ASTUCCIO UTILIZZABILE COME MANICO
SERIES 8 MALE WRENCHES IN CASE THAT CAN BE USED AS A HANDLE



8
pcs.

COD. **65101015**

€ 13,182

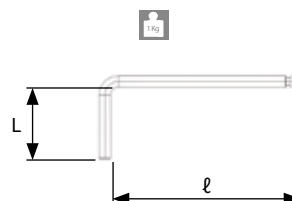

	L mm	ℓ mm
2	16	85
2,5	18	92
3	20	100
4	25	110
5	28	120
6	32	140
8	36	160
10	40	180

COD. **65101035**

€ 13,662

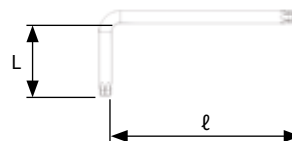

	L mm	ℓ mm
TX10	17	86
TX15	18	90
TX20	19	95
TX25	20	100
TX30	21	105
TX40	26	124
TX45	29	133
TX50	32	152

COD. **65101045**

€ 14,141

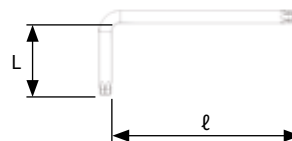

	L mm	ℓ mm
TXH10	17	86
TXH15	18	90
TXH20	19	95
TXH25	20	100
TXH30	21	105
TXH40	26	124
TXH45	29	133
TXH50	32	152



EURO-HOLE

95 X 240 mm



FOCUS ON



La custodia, dotata di gancio di sicurezza, diventa anche una pratica impugnatura per manovrare ogni chiave in modo più confortevole.

The housing, equipped with safety hook, also becomes a practical handle to comfortably manoeuvre each wrench.



65101

SET CHIAVI EXTRA LUNGHE

SERIE 9 PCS. CHIAVI MASCHIO PIEGATE TIPO EXTRA-LUNGO
EXTRA-LONG SERIES 9 MALE WRENCHES



9
pcs.

COD. **65101003**

€ 11,385

65033

1,5	2	2,5	3	4	5	6	8	10
1pc.	1pc.	1pc.	1pc.	1pc.	1pc.	1pc.	1pc.	1pc.

COD. **65101013**

€ 12,703

65036

1,5	2	2,5	3	4	5	6	8	10
1pc.	1pc.	1pc.	1pc.	1pc.	1pc.	1pc.	1pc.	1pc.

COD. **65101033**

€ 13,422

65043

TX10	TX15	TX20	TX25	TX27	TX30	TX40	TX45	TX50
1pc.	1pc.	1pc.	1pc.	1pc.	1pc.	1pc.	1pc.	1pc.

COD. **65101043**

€ 15,340

65046

TXH10	TXH15	TXH20	TXH25	TXH27	TXH30	TXH40	TXH45	TXH50
1pc.	1pc.	1pc.	1pc.	1pc.	1pc.	1pc.	1pc.	1pc.



EURO-HOLE

950 X 310 mm



4 UTENSILI MANUALI MANUAL TOOLS

65101

SET CHIAVI MASCHIO PUNTA MAGNETICA

SERIE 9 PCS. CHIAVI MASCHIO PIEGATE EXTRA-LUNGHE COLORATE PUNTA MAGNETICA
SERIES 9 EXTRA-LONG COLOURED MALE WRENCHES WITH MAGNETIC TIP



9
pcs.

COD. **65101014**

€ 34,754

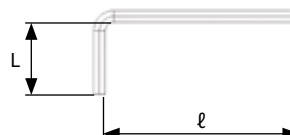

	L mm	ℓ mm
1,5	14	90
2	16	100
2,5	18	112
3	20	126
4	25	142
5	28	160
6	32	180
8	36	200
10	40	224



EURO-HOLE

95 X 310 mm



FOCUS ON



La testa sferica magnetica consente di trattenere la vite in posizione anche in caso di lavori difficili diminuendo il rischio di perdere il fastener.

The spherical magnetic head allows holding the screw in position even during difficult machining, reducing the risk of losing the fastener.



65101

SET CHIAVI EXTRA-LUNGHE TX PUNTA MAGNETICA

SET 9PZ CHIAVI MASCHIO PIEGATE TX EXTRA-LUNGHE COLORATE PUNTA MAGNETICA
9 PCS EXTRA LONG TX WRENCHES COLOURED WITH MAGNETIC TIP









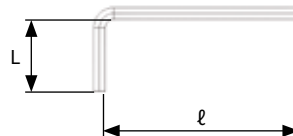

9
pcs.

COD. **65101034**

€ 40,146



	L mm	ℓ mm
 TX10	16	90
 TX15	17	102
 TX20	18	111
 TX25	20	126
 TX27	25	142
 TX30	28	160
 TX40	33	174
 TX45	36	195
 TX50	40	218



88 X 300 mm



EURO-HOLE



FOCUS ON



La testa sferica magnetica consente di trattenere la vite in posizione anche in caso di lavori difficoltosi diminuendo il rischio di perdere il fastener.

The spherical magnetic head allows holding the screw in position even during difficult machining, reducing the risk of losing the fastener.



4 UTENSILI MANUALI

MANUAL TOOLS

65101

SET PIEGHEVOLE CHIAVI MASCHIO

SERIE PIEGHEVOLI CHIAVI MASCHIO
SERIES FOLDING MALE WRENCHES



7
pcs.

COD. **65101016**

€ 8,628

1,5 1pc.	2 1pc.	2,5 1pc.	3 1pc.	4 1pc.	5 1pc.	6 1pc.	8 1pc.
-------------	-----------	-------------	-----------	-----------	-----------	-----------	-----------



EURO-HOLE

170 X 45 X 35 mm

65101

SET PIEGHEVOLE CHIAVI MASCHIO

SERIE PIEGHEVOLI CHIAVI MASCHIO
SERIES FOLDING MALE WRENCHES



8
pcs.

COD. **65101036**

€ 8,748

TX08 1pc.	TX10 1pc.	TX15 1pc.	TX20 1pc.	TX25 1pc.	TX27 1pc.	TX30 1pc.	TX40 1pc.
--------------	--------------	--------------	--------------	--------------	--------------	--------------	--------------



EURO-HOLE

170 X 45 X 35 mm



65101

SET PIEGHEVOLE CHIAVI MASCHIO

SERIE PIEGHEVOLI CHIAVI MASCHIO
SERIES FOLDING MALE WRENCHES



7
pcs.

COD. **65101017**

€ 9,108



1,5 1pc.	2 1pc.	2,5 1pc.	3 1pc.	4 1pc.	5 1pc.	6 1pc.	8 1pc.
-------------	-----------	-------------	-----------	-----------	-----------	-----------	-----------

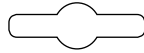

EURO-HOLE

170 X 45 X 35 mm



4 UTENSILI MANUALI MANUAL TOOLS

65051

CHIAVI A "T" ESAGONALI

CHIAVI MASCHIO ESAGONALI IMPUGNATURA A "T"
HEXAGONAL MALE WRENCHES WITH T-SHAPED HANDLE

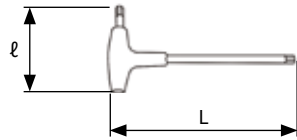
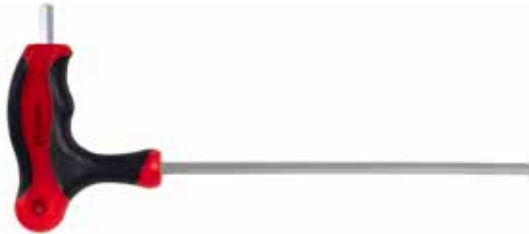

EASYPACK | scatola di cartone - cardboard box

⊙	L mm	ℓ mm	PCS.	COD.	€ cad./each
2	145	65	6	65051005	2,787
2,5	145	67	6	65051010	2,787
3	145	70	6	65051015	2,940
4	210	92	6	65051020	3,187
5	210	92	6	65051025	3,634
6	210	95	6	65051030	3,881
8	280	115	6	65051035	4,668
10	280	117	6	65051040	5,315



SELPACK
1 pc.

⊙	COD.	€ cad./each
2	65051005001	4,338
2,5	65051010001	4,338
3	65051015001	4,494
4	65051020001	4,745
5	65051025001	5,201
6	65051030001	5,453
8	65051035001	6,255
10	65051040001	6,914

65052

CHIAVI A "T" ESAGONO SFERICO

CHIAVI MASCHIO ESAGONALI TESTA SFERICA IMPUGNATURA A "T"
BALL HEAD HEXAGONAL MALE WRENCHES WITH T-SHAPED HANDLE

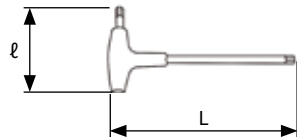
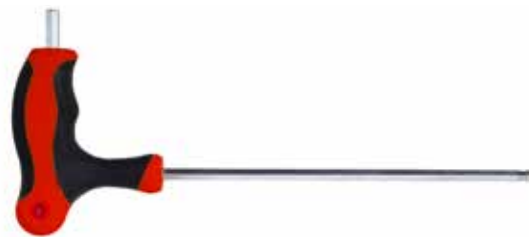

EASYPACK | scatola di cartone - cardboard box

⊙	L mm	ℓ mm	PCS.	COD.	€ cad./each
2	145	65	6	65052005	2,940
2,5	145	67	6	65052010	2,940
3	145	70	6	65052015	3,081
4	210	92	6	65052020	3,363
5	210	92	6	65052025	3,810
6	210	95	6	65052030	4,080
8	280	115	6	65052035	4,916
10	280	117	6	65052040	5,598



SELPACK
1 pc.

⊙	COD.	€ cad./each
2	65052005001	4,452
2,5	65052010001	4,452
3	65052015001	4,594
4	65052020001	4,879
5	65052025001	5,331
6	65052030001	5,603
8	65052035001	6,447
10	65052040001	7,135

**65053**

CHIAVI A "T" A TX

CHIAVI MASCHIO PER VITI TORX® IMPUGNATURA A "T"
MALE WRENCHES FOR TORX® SCREWS WITH T-SHAPED HANDLE

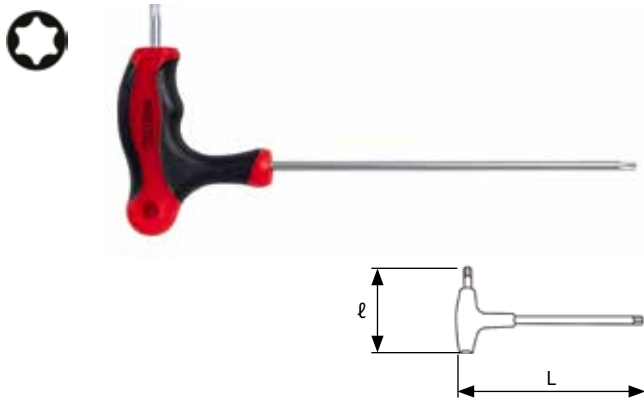
**EASYPACK** | scatola di cartone - cardboard box

	L mm	l mm	PCS.	COD.	€ cad./each
TX06	145	65	6	65053005	2,610
TX07	145	65	6	65053010	2,610
TX08	145	65	6	65053015	2,610
TX09	145	65	6	65053020	2,610
TX10	145	67	6	65053025	3,035
TX15	145	67	6	65053030	3,187
TX20	145	67	6	65053035	3,329
TX25	210	93	6	65053040	3,634
TX27	210	93	6	65053045	4,175
TX30	210	95	6	65053050	4,422
TX40	280	115	6	65053055	5,421
TX45	280	115	6	65053060	5,810

	COD.	€ cad./each
TX06	65053005001	4,158
TX07	65053010001	4,158
TX08	65053015001	4,158
TX09	65053020001	4,158
TX10	65053025001	4,590
TX15	65053030001	4,745
TX20	65053035001	4,890
TX25	65053040001	5,201
TX27	65053045001	5,752
TX30	65053050001	6,004
TX40	65053055001	7,022
TX45	65053060001	7,418

**SELPACK**
1 pc.



4 UTENSILI MANUALI MANUAL TOOLS

65101

SET CHIAVI A "T"

SERIE 8 PCS. CHIAVI MASCHIO IMPUGNATURA A "T"
SERIES 8 MALE WRENCHES WITH T-SHAPED HANDLE



8
pcs.



290 X 90 X 120 mm

COD. **65101100**

€ 40,746

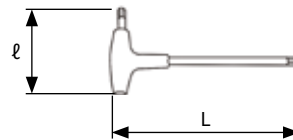

	L mm	l mm
2	145	65
2,5	145	67
3	145	70
4	210	92
5	210	92
6	210	95
8	280	115
10	280	117

COD. **65101105**

€ 39,787

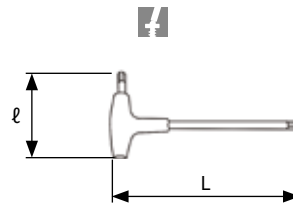

	L mm	l mm
2	145	65
2,5	145	67
3	145	70
4	210	92
5	210	92
6	210	95
8	280	115
10	280	117

COD. **65101110**

€ 40,746

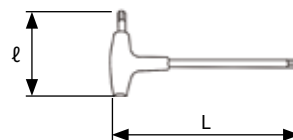

	L mm	l mm
TX10	145	67
TX15	145	67
TX20	145	67
TX25	210	93
TX27	210	93
TX30	210	95
TX40	280	115
TX45	280	115

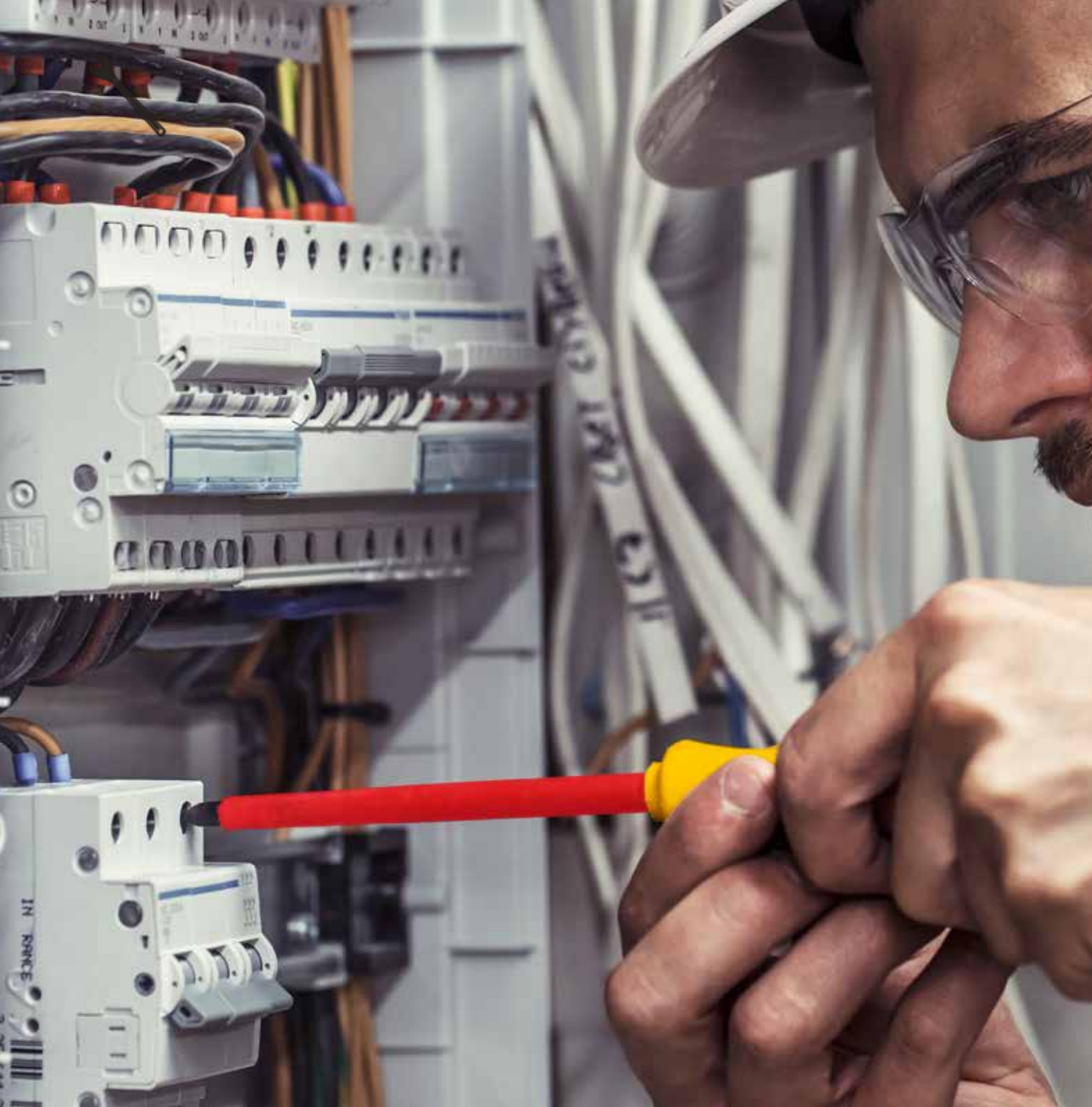

Installazione di un quadro elettrico.
Installation of an electrical panel.



4 UTENSILI MANUALI MANUAL TOOLS

65054

CHIAVI A TRE TESTE ESAGONALI

CHIAVI A TRE TESTE ESAGONALI CON ASTA SCORREVOLE
3 WAY HEX MALE WRENCHES WITH SLIDING BAR



EASYPACK scatola di cartone - cardboard box						
Ø	L mm	Ø ₁ mm	Ø ₂ mm	PCS.	COD.	€ cad./each
2	125	65		6	65054005	11,254
2,5	125	65		6	65054010	11,254
3	125	65		6	65054015	11,467
3,5	125	65		6	65054020	11,467
4	180	90		6	65054025	11,467
4,5	180	90		6	65054030	13,462
5	180	90		6	65054035	14,103
6	210	105		6	65054040	15,527
8	250	125		6	65054045	18,162
10	300	145		6	65054050	20,085
12	320	165		6	65054055	24,786
14	340	170		6	65054060	29,060

65055

CHIAVI A TRE TESTE TX

CHIAVI A TRE TESTE TX CON ASTA SCORREVOLE
3 WAY TX MALE WRENCHES WITH SLIDING BAR



EASYPACK scatola di cartone - cardboard box						
Ø	L mm	Ø ₁ mm	Ø ₂ mm	PCS.	COD.	€ cad./each
TX10	125	65		6	65055005	12,087
TX15	125	65		6	65055010	12,087
TX20	125	65		6	65055015	12,087
TX25	180	90		6	65055020	14,865
TX27	180	90		6	65055025	14,865
TX30	180	90		6	65055030	14,865
TX40	210	105		6	65055035	16,366
TX45	250	125		6	65055040	19,219
TX50	250	125		6	65055045	19,219

**65101**

SET CHIAVI A TRE TESTE

SERIE 6 PCS. CHIAVI MASCHIO A TRE TESTE CON ASTA SCORREVOLE
SERIES 6 PCS. 3 WAY HEX MALE WRENCHES WITH SLIDING BAR

EASYPACK | scatola di cartone - cardboard box

6
pcs.COD. **65101120**

€ 73,800



2,5 1pc.	3 1pc.	4 1pc.	5 1pc.	6 1pc.	8 1pc.
-------------	-----------	-----------	-----------	-----------	-----------

65101

SET CHIAVI A TRE TESTE

SERIE 6 PCS. CHIAVI TX A TRE TESTE CON ASTA SCORREVOLE
SERIES 6 PCS. 3 WAY TX WRENCHES WITH SLIDING BAR

EASYPACK | scatola di cartone - cardboard box

6
pcs.COD. **65101125**

€ 74,100



TX10 1pc.	TX15 1pc.	TX20 1pc.	TX25 1pc.	TX30 1pc.	TX40 1pc.
--------------	--------------	--------------	--------------	--------------	--------------



4 UTENSILI MANUALI MANUAL TOOLS

65201

CHIAVI COMBinate

CHIAVI COMBinate FINITURA SEMILUCIDA
COMBINATION WRENCHES MATT FINISH

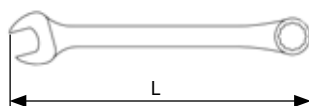

EASYPACK | scatola di cartone - cardboard box

Ø	L mm	PCS.	COD.	€ cad./each
6	95	6	65201005	1,583
7	105	6	65201010	1,638
8	120	6	65201015	1,694
9	130	6	65201020	1,750
10	140	6	65201025	1,848
11	150	6	65201030	2,058
12	160	6	65201035	2,268
13	170	6	65201040	2,423
14	180	6	65201045	2,534
15	190	6	65201050	3,010
16	200	6	65201055	3,220
17	210	6	65201060	3,696
18	220	6	65201065	4,018
19	230	6	65201070	4,396
20	245	6	65201075	5,516
21	255	6	65201080	5,558
22	260	6	65201085	5,768
23	275	6	65201090	7,028
24	285	6	65201095	7,518
25	295	6	65201100	9,310
26	310	6	65201105	9,590
27	320	6	65201110	10,010
28	330	6	65201115	12,390
29	340	6	65201120	12,573
30	340	6	65201125	12,936
32	360	6	65201130	13,286

Ø	COD.	€ box
6	65201005001	3,083
7	65201010001	3,138
8	65201015001	3,194
9	65201020001	3,250
10	65201025001	3,348
11	65201030001	3,558
12	65201035001	3,768
13	65201040001	3,923
14	65201045001	4,034
15	65201050001	4,510
16	65201055001	4,720
17	65201060001	5,196
18	65201065001	5,518
19	65201070001	5,896
20	65201075001	7,016
21	65201080001	7,058
22	65201085001	7,268
23	65201090001	8,528
24	65201095001	9,018
25	65201100001	10,810
26	65201105001	11,090
27	65201110001	11,510
28	65201115001	13,890
29	65201120001	14,073
30	65201125001	14,436
32	65201130001	14,786



SELPACK
1 pc.

**65301****SET CHIAVI COMBINATE****SERIE 12 PCS. CHIAVI COMBINATE IN BUSTA**
SERIES 12 COMBINATION WRENCHES**12
pcs.**

445 x 335 mm

COD. **65301001****€ 26,880**

6	7	8	9	10	11	12	13	14	17	19	22
1pc.	1pc.	1pc.	1pc.	1pc.	1pc.	1pc.	1pc.	1pc.	1pc.	1pc.	1pc.

65301**SET CHIAVI COMBINATE****SERIE 25 PCS. CHIAVI COMBINATE IN BUSTA**
SERIES 25 COMBINATION WRENCHES**25
pcs.**

695 X 590 mm

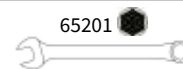
COD. **65301002****€ 104,720**

6	7	8	9	10	11	12	13	14
1pc.	1pc.	1pc.	1pc.	1pc.	1pc.	1pc.	1pc.	1pc.

15	16	17	18	19	20	21	22	23
1pc.	1pc.	1pc.	1pc.	1pc.	1pc.	1pc.	1pc.	1pc.

24	25	26	27	28	30	32
1pc.	1pc.	1pc.	1pc.	1pc.	1pc.	1pc.



4 UTENSILI MANUALI MANUAL TOOLS

65200

CHIAVI A FORCHETTA DOPPIE

CHIAVI A FORCHETTA DOPPIE
DOUBLE OPEN ENDED WRENCHES

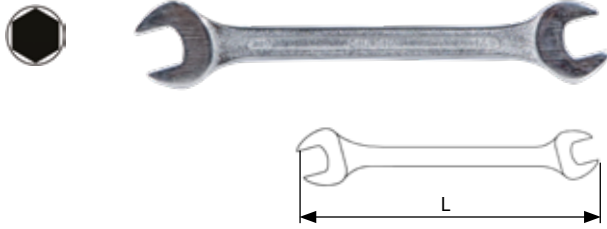

EASYPACK | scatola di cartone - cardboard box

Ø	L mm	PCS.	COD.	€ cad./each
6X7	130	6	65200005	1,736
8X9	140	6	65200010	2,016
10X11	160	6	65200015	2,310
12X13	175	6	65200020	2,633
14X15	185	6	65200025	3,193
16X17	200	6	65200030	3,934
18X19	215	6	65200035	4,914
20X22	235	6	65200040	6,146
21X23	240	6	65200045	7,126
24X27	270	6	65200050	8,344
25X28	280	6	65200055	8,400
30X32	300	6	65200060	11,536

65300

SET CHIAVI A FORCHETTA DOPPIE

SERIE 12 PCS. CHIAVI A FORCHETTA DOPPIE
SERIES 12 DOUBLE OPEN ENDED WRENCHES

12
pcs.

COD. **65300001**

€ 61,712

65200



6x7 1pc.	8x9 1pc.	10x11 1pc.	12x13 1pc.	14x15 1pc.	16x17 1pc.
18x19 1pc.	20x22 1pc.	21x23 1pc.	24x27 1pc.	25x28 1pc.	30x32 1pc.



445 x 335 mm



65203

CHIAVI POLIGONALI DOPPIE CURVE

CHIAVI POLIGONALI DOPPIE CURVE
DOUBLE ENDED DEEP OFFSET RING WRENCHES

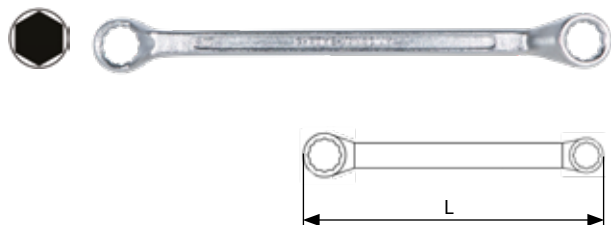

EASYPACK | scatola di cartone - cardboard box

Ø	L mm	PCS.	COD.	€ cad./each
6X7	175	6	65203005	2,730
8X9	190	6	65203010	3,248
10X11	200	6	65203015	3,500
12X13	220	6	65203020	3,963
14X15	240	6	65203025	4,774
16X17	255	6	65203030	5,993
18X19	280	6	65203035	6,973
20X22	300	6	65203040	8,723
21X23	320	6	65203045	10,374
24X27	340	6	65203050	12,320
25X28	340	6	65203055	12,376
30X32	370	6	65203060	15,750



65303

SET CHIAVI POLIGONALI DOPPIE CURVE

SERIE 12 PCS. CHIAVI POLIGONALI DOPPIE CURVE
SERIES 12 DOUBLE ENDED DEEP OFFSET RING WRENCHES

12
pcs.

COD. **65303001**

€ 76,496



445 x 335 mm

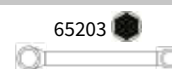

6x7 1pc.	8x9 1pc.	10x11 1pc.	12x13 1pc.	14x15 1pc.	16x17 1pc.
18x19 1pc.	20x22 1pc.	21x23 1pc.	24x27 1pc.	25x28 1pc.	30x32 1pc.

4



4 UTENSILI MANUALI MANUAL TOOLS

65208

CHIAVI A CRICCHETTO

CHIAVI DOPPIE A CRICCHETTO CR-V FINITURA A SPECCHIO
DOUBLE END RATCHET WRENCHES CR-V MIRROR FINISH

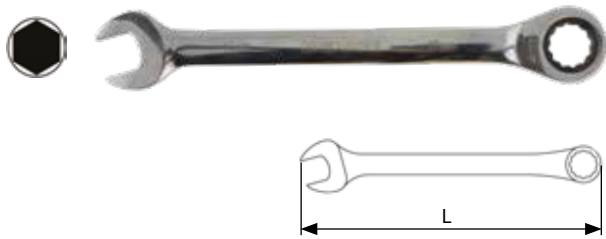

EASYPACK | scatola di cartone - cardboard box

Ø	L mm	PCS.	COD.	€ cad./each
8	140	6	65208015	7,790
9	148	6	65208020	7,993
10	162	6	65208025	8,472
11	166	6	65208030	8,688
12	174	6	65208035	9,684
13	178	6	65208040	10,175
14	192	6	65208045	10,450
15	200	6	65208050	10,942
16	212	6	65208055	11,661
17	225	6	65208060	12,823
18	238	6	65208065	13,422
19	246	6	65208070	13,782

Ø	COD.	€ box
8	65208015001	9,290
9	65208020001	9,493
10	65208025001	9,972
11	65208030001	10,188
12	65208035001	11,184
13	65208040001	11,675
14	65208045001	11,950
15	65208050001	12,442
16	65208055001	13,161
17	65208060001	14,323
18	65208065001	14,922
19	65208070001	15,282



SELPACK
1 pc.



65310

SET CHIAVI A CRICCHETTO

SERIE 6 PCS. CHIAVI DOPPIE A CRICCHETTO
SERIES 6 DOUBLE RATCHET WRENCHES



6
pcs.

230 X 110 X 30 mm

COD. **65310001**

€ 60,610

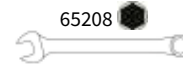

8 1pc.	10 1pc.	12 1pc.	13 1pc.	14 1pc.	17 1pc.
-----------	------------	------------	------------	------------	------------

65310

SET CHIAVI A CRICCHETTO

SERIE 12 PCS. CHIAVI DOPPIE A CRICCHETTO
SERIES 12 DOUBLE RATCHET WRENCHES



12
pcs.

250 X 250 X 30 mm

COD. **65310002**

€ 127,820

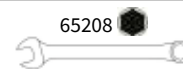

8 1pc.	9 1pc.	10 1pc.	11 1pc.	12 1pc.	13 1pc.
14 1pc.	15 1pc.	16 1pc.	17 1pc.	18 1pc.	19 1pc.



4 UTENSILI MANUALI MANUAL TOOLS

65210

CHIAVI A CRICCHETTO E SNODO

CHIAVI DOPPIE A CRICCHETTO SNODATE CR-V FINITURA A SPECCHIO
DOUBLE END FLEXIBLE RATCHET WRENCHES CR-V WITH MIRROR FINISH

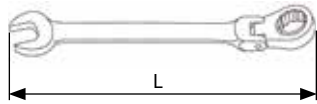

EASYPACK | scatola di cartone - cardboard box

Ø	L mm	PCS.	COD.	€ cad./each
8	140	6	65210015	10,626
9	148	6	65210020	11,463
10	162	6	65210025	11,708
11	166	6	65210030	12,223
12	174	6	65210035	13,524
13	178	6	65210040	13,782
14	192	6	65210045	14,683
15	200	6	65210050	15,198
16	212	6	65210055	15,971
17	225	6	65210060	17,517
18	238	6	65210065	18,547
19	246	6	65210070	18,934

Ø	COD.	€ box
8	65210015001	12,126
9	65210020001	12,963
10	65210025001	13,208
11	65210030001	13,723
12	65210035001	15,024
13	65210040001	15,282
14	65210045001	16,183
15	65210050001	16,698
16	65210055001	17,471
17	65210060001	19,017
18	65210065001	20,047
19	65210070001	20,434



SELPACK
1 pc.



65315

SET CHIAVI A CRICCHETTO E SNODO

SERIE 6 PCS. CHIAVI DOPPIE A CRICCHETTO SNODATE
SERIES 6 DOUBLE END FLEXIBLE RATCHET WRENCHES



230 X 180 X 30 mm

6
pcs.

COD. **65315001**

€ 77,165

65210



8 1pc.	10 1pc.	12 1pc.	13 1pc.	14 1pc.	17 1pc.
-----------	------------	------------	------------	------------	------------

65315

SET CHIAVI A CRICCHETTO E SNODO

SERIE 12 PCS. CHIAVI DOPPIE A CRICCHETTO SNODATE
SERIES 12 DOUBLE END FLEXIBLE RATCHET WRENCHES



250 X 250 X 30 mm

12
pcs.

COD. **65315002**

€ 162,610

65210



8 1pc.	9 1pc.	10 1pc.	11 1pc.	12 1pc.	13 1pc.
14 1pc.	15 1pc.	16 1pc.	17 1pc.	18 1pc.	19 1pc.



4 UTENSILI MANUALI MANUAL TOOLS

65301

SET CHIAVI COMBinate COLORATE

SERIE 6 PCS. CHIAVI COMBinate COLORATE, OGNI MISURA UN COLORE
SERIES 6 COLOURED COMBINATION WRENCHES, A COLOUR FOR EACH SIZE



6
pcs.

220 X 110 X 45 mm

COD. **65301050**

€ 47,040

65201					
8 1pc.	10 1pc.	12 1pc.	13 1pc.	14 1pc.	17 1pc.

65216

CHIAVE PER PONTEGGI

CHIAVE DOPPIA POLIGONALE A CRICCHETTO PER PONTEGGI
DOUBLE POLYGONAL RATCHET WRENCH FOR SCAFFOLDING

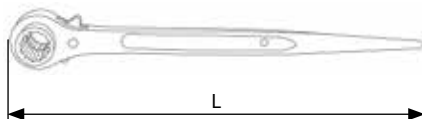

L mm			PCS.	COD.	€ cad./each
315	22	21	1	65216025	31,360



335 X 80 X 60 mm



64230

ASSORTIMENTI UTENSILI MANUALI

ASSORTIMENTO 30 PCS UTENSILI MANUALI IN ASTUCCIO DI NYLON
30 PCS HAND TOOLS SET IN NYLON POUCH

















30
pcs.

205 X 60 X 350 mm

COD. **64230510**

€ 84,437

	5	7		3					
	PH1	PH2		PH0					
	6x7	8x9	10x11	12x13	14x15	16x17			
	1,5	2	2,5	3	4	5	6	8	10
	TESTER 250V			160mm					
	250mm			200mm					
	160mm			300gr					
	3m		insulated		160mm				



4 UTENSILI MANUALI

MANUAL TOOLS

64230

ASSORTIMENTI UTENSILI MANUALI

ASSORTIMENTO 52 PCS UTENSILI MANUALI IN ASTUCCIO DI NYLON
52 PCS HAND TOOLS SET IN NYLON POUCH

52
pcs.



140 X 40 X 200 mm

COD. **64230515**

€ 81,144

	PH0	PH1 2pcs.	PH2 2pcs.	PH3							
	PZ0	PZ1 2pcs.	PZ2 2pcs.	PZ3							
	TX10	TX15	TX20	TX25	TX27	TX30					
	2,5	3	4	5	5,5	6					
	3x0,5	4x0,6	5x0,8	5,5x1	6x1,2	7x1,2					
	1/4	4	5	6	7	8	9	10	11	12	13
	1/4										
		3x75mm	6x100mm								
		PH1x75mm	PH2x100mm								
	160mm			250mm							
	180mm			TESTER 250V							
	3m			200gr							



64230

ASSORTIMENTI UTENSILI MANUALI

ASSORTIMENTO 50 PCS UTENSILI MANUALI VALIGETTA IN TERMOFORMATO

50
pcs.

COD. **64230400**

€ 85,495



380 X 80 X 330 mm



	4,0	5,5	6,5					
	PH1	PH2						
	PZ1	PZ2						
	TX10	TX15	TX20	TX25	TX30			
1/4"x25mm		3	4	5	6			
				1,5	2	2,5	3	
				4	5	5,5	6	
	6x7	8x9	10x11	12x13	14x15	16x17		
		4						1,5
		PH2						PH0
	180mm					TESTER 250V		
	5 pcs.					180mm		
	250mm					160mm		
	2 pcs					180mm		
	3m					200gr		

PORTA-UTENSILI

BORSE E CONTENITORI PORTA-UTENSILI
Tool bags and containers

tested by



MATLEY



Realizzate in poliestere 600d, doppie cuciture nei punti più delicati, fibbie e moschettoni in metallo.

Made of 600d polyester, double stitching at the most delicate points, metal buckles and snap hooks.



Maniglie rinforzate e rivestite in morbida gomma antiscivolo, spallacci imbottiti.

Reinforced handles covered in soft non-slip rubber, padded shoulder straps.



Piedini e fondi rivestiti in gomma impermeabile.

Feet and bottoms covered with waterproof rubber.

**65991**

FODERO PORTA TRAPANO

FODERO PORTA TRAPANO 7 TASCHE
DRILL HOLDER 7 POCKETS

17x30 cm

COD.	€ cad./each
65991001	17,227



- Poliestere 600 denari, ad altissima resistenza
- Passante posteriore per cintura
- Tasca porta trapano con fibbia di chiusura
- Sette tasche aggiuntive

- 600 denier polyester, very high resistance
- Rear belt loop
- Drill pocket with locking buckle
- Seven additional pockets

65991

FODERO PORTAUTENSILI CON CINTURA

FODERO PORTAUTENSILI CON CINTURA 8 TASCHE
TOOL HOLDER COVER WITH BELT 8 POCKETS

28x19,5 cm

COD.	€ cad./each
65991003	18,297



- Poliestere 600 denari, ad altissima resistenza
- Cintura regolabile inclusa
- Otto robuste tasche imbottite
- Due ganci metallici per flessometro e chiave combinata
- Cordino con moschettone, due passanti in tessuto

- 600 denier polyester, very high resistance
- Adjustable belt included
- Eight sturdy padded pockets
- Two metal hooks for tape measure and combination wrench
- Lanyard with carabiner, two fabric loops



4 UTENSILI MANUALI

MANUAL TOOLS

65991

BORSA PER UTENSILI CON CINTURA

BORSA PER UTENSILI CON CINTURA 8 TASCHE
BAG FOR TOOLS WITH BELT 8 POCKETS



23,5x23,5x15 cm

COD.	€ cad./each
65991005	26,536



- Poliestere 600 denari, ad altissima resistenza
- Cintura regolabile inclusa
- Otto tasche di cui una a marsupio
- Gancio metallico per flessometro

- 600 denier polyester, very high resistance
- Adjustable belt included
- Eight pockets, one of which is a pouch
- Metal measuring tape hook

65991

CESTELLO APPENDIBILE

CESTELLO APPENDIBILE 22 TASCHE
HANGING BASKET 22 POCKETS



22x35x22 cm

COD.	€ cad./each
65991020	39,760



- Poliestere 600 denari, ad altissima resistenza
- Manico sganciabile
- Piedini in gomma, cordino con moschettone
- Ventidue tasche esterne
- 3 separatori interni

- 600 denier polyester, very high resistance
- Detachable handle
- Rubber feet, lanyard with snap hook
- Twenty-two external pockets
- 3 internal separators

**65991**

CESTELLO RIPIEGABILE CON TRACOLLA

CESTELLO RIPIEGABILE CON TRACOLLA 19 TASCHE
FOLDABLE BASKET WITH SHOULDER STRAP 19 POCKETS

19**15kg****10L**

40x20x30 cm

COD.	€ cad./each
65991021	42,372



- Poliestere 600 denari ad altissima resistenza
- Struttura ripiegabile
- Manico tubolare in metallo, pieghevole
- Impugnatura in morbida gomma
- Tracolla sganciabile
- 19 tasche e passanti porta-utensili

- 600 denier polyester, very high resistance
- Foldable structure
- Folding tubular metal handle
- Soft rubber handle
- Detachable shoulder strap
- 19 pockets and tool loops

65991

CESTELLO RICHIUDIBILE CON TRACOLLA

CESTELLO RICHIUDIBILE CON TRACOLLA 24 TASCHE
REFILLABLE BASKET WITH SHOULDER STRAP 24 POCKETS

24**20kg****25L**

44x25x34 cm

COD.	€ cad./each
65991025	68,908



- Poliestere 600 denari ad altissima resistenza
- Struttura rigida
- Manico tubolare in metallo
- Impugnatura in morbida gomma
- Tracolla sganciabile e copertura rimovibile
- 24 tasche e passanti porta-utensili
- Fondo in gomma anti-urto

- 600 denier polyester, very high resistance
- Rigid structure
- Tubular metal handle
- Soft rubber handle
- Detachable shoulder strap and removable cover
- 24 pockets and tool loops
- Anti-shock rubber base



4 UTENSILI MANUALI

MANUAL TOOLS

65991

BORSA FONDO RIGIDO CON TRACOLLA

BORSA FONDO RIGIDO CON TRACOLLA 52 TASCHE
RIGID BASE BAG WITH SHOULDER STRAP 52 POCKETS



43x38x30 cm

COD.	€ cad./each
65991030	63,344



- Poliestere 600 denari ad altissima resistenza
- Fondo in gomma anti-urto
- Fornita con tracolla
- 52 tasche e passanti porta-utensili

- 600 denier polyester, very high resistance
- Anti-shock rubber base
- Supplied with shoulder strap
- 52 pockets and tool loops

65991

GILET TECNICO

GILET TECNICO DA LAVORO MULTITASCHE
MULTIPOCKET TECHNICAL WORK VEST



65x50 cm

COD.	€ cad./each
65991040	64,414



- Poliestere 600 denari ad altissima resistenza
- Realizzato in tessuto a rete ad alta traspirazione
- Taglia unica con fibbie laterali per la regolazione
- Spalline apribili con chiusura a strappo
- Bande catarifrangenti

- 600 denier polyester, very high resistance
- Made of highly breathable mesh fabric
- One size with side buckles for adjustment
- Shoulder straps that can be opened with Velcro closure
- Reflective bands

**65991**

TROLLEY CON ORGANIZER

TROLLEY CON ORGANIZER 57 TASCHE

TROLLEY WITH ORGANISER

57

20kg

30L



37x22x54 cm

COD.	€ cad./each
65991015	133,750



- Poliestere 600 denari, ad altissima resistenza
- Manico telescopico di trasporto
- Ruote integrate nella struttura
- Fornito con paniere interno porta-utensili removibile
- Scomparti interni porta-PC o Tablet
- Spallacci imbottiti con moschettoni metallici
- Manico rinforzato e rivestito in gomma
- Fondo con piedini

- *600 denier polyester, very high resistance*
- *Telescopic transport handle*
- *Wheels integrated into the structure*
- *Supplied with removable internal tool holder basket*
- *Internal compartments for a laptop or tablet*
- *Shoulder straps with metal snap hooks*
- *Reinforced rubber-coated handle*
- *Base with feet*



4 UTENSILI MANUALI MANUAL TOOLS

65991

CASSETTE PORTAUTENSILI IN METALLO

CASSETTE PORTAUTENSILI CON VASSOIO INTERNO ESTRAIBILE
METAL TOOL BOXES WITH INTERNAL REMOVABLE TRAY



390 X 180 X 170 mm

COD.	€ cad./each
65991101	44,726



470 X 240 X 210 mm

COD.	€ cad./each
65991102	62,274



580 X 270 X 260 mm

COD.	€ cad./each
65991103	90,736

65991

SET CASSETTE PORTAUTENSILI

SET 3 PCS CASSETTE PORTAUTENSILI CON VASSOI INTERNI
SET 3 PCS TOOL BOXES WITH INTERNAL TRAYS



COD.	€ cad./each
65991100	172,805

65991

CARRELLO SCOMPONIBILE

CARRELLO SCOMPONIBILE IN TRE PARTI, CON SEPARATORI INTERNI
TROLLEY CAN BE SPLIT INTO THREE PARTS, WITH INTERNAL SEPARATORS

COD.	€ cad./each
65991110	211,539



FOCUS ON





MODULI ESPOSITIVI

WALL DISPLAY SYSTEM

SISTEMA A MODULI PER L'ALLESTIMENTO DI PARETI ATTREZZATE A LIBERO SERVIZIO

MODULAR SYSTEM FOR FREE STANDING WALL DISPLAY SYSTEM.

	
MODULO 1	MODULO 2
MODULO 3	MODULO 4
MODULO 5	MODULO 6
MODULO 7	MODULO 8
MODULO 9	MODULO 10
MODULO 11	MODULO 12

Componi la tua parete in 5 mosse:

Compose your display wall in 5 moves:

- 1** Individua la categoria merceologica di tuo interesse.
Identify the product category of your interest.
- 2** Individua la famiglia prodotto di tuo interesse.
Identify the product family of your interest.
- 3** Scegli la profondità di assortimento desiderata tra soluzioni a 1 o più moduli.
Choose the desired assortment depth from 1- or multi-module solutions.
- 4** Individua codice e prezzo del modulo pre assortito.
Identify pre-sorted module code and price.
- 5** Infine, componi il mix di assortimento che risponde alle tue esigenze.
Grazie al sistema espositivo multilivello, per ogni metro lineare è possibile comporre la tua esposizione in modo flessibile, sfruttando un massimo di 12 moduli espositivi.
Finally, compose the assortment mix that meets your needs.
With the multilevel display system, for each linear meter you can flexibly compose your display, taking advantage of up to 12 display modules.

Rivolgiti all'agente di zona per consultare il dettaglio di ciascun assortimento e per ulteriori informazioni.

Contact your local agent to see the details of each assortment and for more information.

1

2

3

4

CATEGORIA MERCEOLOGICA
CATEGORIA MERCEOLOGICAFAM. PRODOTTO
PRODUCT FAMILYDESCRIZIONE ARTICOLO
DESCRIZIONE ARTICOLON. MODULI
N. MODULICOD. MODULO
COD. MODULOLISTINO €
LISTINO €INSERTI ESSENTIAL
INSERTI ESSENTIAL

61001	INSERTI 1/4 C6,3 ESAGONALI			
66002170	MYBIT 7 ESSENTIAL ESAGONALI	1	66001600	264,730 €
66005170	MYBIT 10 ESSENTIAL ESAGONALI			
61043	INSERTI 1/4 C6,3 PH			
61051	LAME 1/4 E6,3 PH	1	66001601	228,620 €
66002105	MYBIT 7 ESSENTIALPH - PZ - TAGLIO			
61069	INSERTI 1/4 C6,3 PZ			
61076	LAME 1/4 E6,3 PZ	1	66001602	228,620 €
66002105	MYBIT 7 ESSENTIALPH - PZ - TAGLIO			
61043	INSERTI 1/4 C6,3 PH			
61051	LAME 1/4 E6,3 PH			
61069	INSERTI 1/4 C6,3 PZ			
61076	LAME 1/4 E6,3 PZ	2	66001603	415,050 €
66005115	MYBIT 10 ESSENTIAL PH - PZ - TX			
66006020	MYBIT 15 ESSENTIAL PH - PZ - TX - TAGLIO			
66002105	MYBIT 7 ESSENTIAL PH - PZ - TAGLIO			
61094	INSERTI 1/4 C6,3 TX			
61097	LAME 1/4 E6,3 TX	2	66001604	373,590 €
66002115	MYBIT 7 ESSENTIAL TX			
61094	INSERTI 1/4 C6,3 TX			
61097	LAME 1/4 E6,3 TX	1	66001605	224,280 €
66002115	MYBIT 7 ESSENTIAL TX			
61001	INSERTI 1/4 C6,3 ESAG.			
61021	INSERTI 1/4 C6,3 TAGLIO	1	66001606	240,440 €
66002170	MYBIT 7 ESSENTIAL ESAG.			
61043	INSERTI 1/4 C6,3 PH			
61051	LAME 1/4 E6,3 PH			
61069	INSERTI 1/4 C6,3 PZ			
61076	LAME 1/4 E6,3 PZ			
61001	INSERTI 1/4 C6,3 ESAGONALI			
61021	INSERTI 1/4 C6,3 TAGLIO			
61094	INSERTI 1/4 C6,3 TX	4	66001607	879,770 €
61097	LAME 1/4 E6,3 TX			
66005115	MYBIT 10 ESSENTIAL PH - PZ - TX			
66006020	MYBIT 15 ESSENTIAL PH - PZ - TX - TAGLIO			
66002105	MYBIT 7 ESSENTIAL PH - PZ - TAGLIO			
66002170	MYBIT 7 ESSENTIAL ESAGONO			
66002115	MYBIT 7 ESSENTIAL TX			

1

2

3

4

CATEGORIA MERCEOLOGICA CATEGORIA MERCEOLOGICA	COD. FAMIGLIA COD. FAMIGLIA	DESCRIZIONE ARTICOLO DESCRIZIONE ARTICOLO	N. MODULI N. MODULI	COD. MODULO COD. MODULO	LISTINO € LISTINO €
INSERTI ESSENTIAL INSERTI ESSENTIAL	61043	INSERTI 1/4 C6,3 PH	4	66001608	921,950 €
	61051	LAME 1/4 E6,3 PH			
	61069	INSERTI 1/4 C6,3 PZ			
	61076	LAME 1/4 E6,3 PZ			
	61001	INSERTI 1/4 C6,3 ESAGONALI			
	61021	INSERTI 1/4 C6,3 TAGLIO			
	61094	INSERTI 1/4 C6,3 TX			
	61097	LAME 1/4 E6,3 TX			
	66002105	MYBIT 7 ESSENTIAL PH - PZ - TAGLIO			
	66002170	MYBIT 7 ESSENTIAL ESAGONO			
	66002115	MYBIT 7 ESSENTIAL TX			
INSERTI PULSAR INSERTI PULSAR	61210	INSERTI 1/4 C PULSAR PH	2	66001609	763,440 €
	61211	LAME 1/4 E PULSAR PH			
	61220	INSERTI 1/4 C PULSAR PZ			
	61211	LAME 1/4 E PULSAR PH			
	61230	INSERTI 1/4 C PULSAR TX			
	62035005001	PORTAINSERI1/4 E MAGNETICI PULSAR			
	66002200	MYBIT 7 PULSAR PH - PZ - TX			
	66005215	MYBIT 10 PULSAR PH - PZ - TX			
INSERTI TORSION+ INSERTI TORSION+	61250	INSERTI 1/4C TORSION+ PH	2	66001610	537,200 €
	61251	LAME 1/4E TORSION+ PH			
	61260	INSERTI 1/4C TORSION + PZ			
	61261	LAME 1/4E TORSION + PZ			
	61270	INSERTI 1/4C TORSION + TX			
	61271	LAME 1/4 E TORSION + TX			
	66002360	MYBIT 7 TORSION+ PH - PZ - TX			
	66005350	MYBIT 10 TOESION+ PH - PZ - TX			
INSERTI MAG-BIT COLOUR+ INSERTI MAG-BIT COLOUR+	61355	INSERTI 1/4C MAG-BIT +COLOR PH	2	66001611	770,010 €
	61356	LAME 1/4E MAG-BIT +COLOR PH			
	61365	INSERTI 1/4C MAG-BIT +COLOR PZ			
	61366	LAME 1/4E MAG-BIT +COLOR PZ			
	61375	INSERTI 1/4C MAG-BIT +COLOR TX			
	61376	LAME 1/4E MAG-BIT +COLOR TX			
	66002445	MYBIT 7 MAG-BIT +COLOR PH - PZ - TX			
INSERTI COLOUR+ INSERTI COLOUR+	61450	INSERTI 1/4C COLOR PH	2	66001612	622,880 €
	61451	LAME 1/4E COLOR PH			
	61460	INSERTI 1/4C COLOR PZ			
	61461	LAME 1/4E COLOR PZ			
	61470	INSERTI 1/4C COLOR TX			
	61471	LAME 1/4E COLOR TX			
	66002430	MYBIT 7 COLOR PH - PZ			
	66006530	MYBIT 14 COLOUR CRICCHETTO			

1

2

3

4

CATEGORIA MERCEOLOGICA CATEGORIA MERCEOLOGICA	COD. FAMIGLIA COD. FAMIGLIA	DESCRIZIONE ARTICOLO DESCRIZIONE ARTICOLO	N. MODULI N. MODULI	COD. MODULO COD. MODULO	LISTINO € LISTINO €
INSERTI TITANIUM INSERTI TITANIUM	61045	INSERTI 1/4 C6,3 TITANIUM PH	2	66001613	591,660 €
	61071	INSERTI 1/4 C6,3 TITANIUM PZ			
	61026	INSERTI 1/4 C6,3 TITANIUM TAGLIO			
	61095	INSERTI 1/4 C6,3 TITANIUM TX			
	66002110	MYBIT 7 TITANIUM PH - PZ - TAGLIO			
	66005130	MYBIT 10 TITANIUM PH - PZ - TX - TAGLIO			
PORTA-INSERTI E PROLUNGHE PORTA-INSERTI E PROLUNGHE	62015	PORTAINSERI 1/4EX1/4X25 MAGNETICI +ANELLO	1	66001614	469,180 €
	62017	PORTAINSERI CARTONGESSO BATTUTA FISSA			
	62019	PORTAINSERI MAGNETICI+BLOCCO+SGANCIO			
	62035	PORTAINSERI 1/4 E MAGNETICI PULSAR			
	62025	PORTAINSERI Q 1/4 X1/4X25 ANELLO			
	62173	PROLUNGA CROM. 1/4 X 1/4			
PORTA-INSERTI ED ADATTATORI PORTA-INSERTI ED ADATTATORI	62015	PORTAINSERI 1/4EX1/4X25 M+ANELLO	1	66001615	456,070 €
	62016	PORTAINSERI 1/4EX1/4X25 M+BLOCCO			
	62017	PORTAINSERI CARTONGESSO BATT.FISSA			
	62101	ADATT. 1/4 E6,3 X Q 1/4			
	62111	ADATT. 1/4 E6,3 X Q 3/8			
	62121	ADATT. 1/4 E6,3 X Q 1/2			
	62601001	SET ADATTATORI 1/4 -3/8 -1/2			
CHIAVI A BUSSOLA CHIAVI A BUSSOLA	63004	CHIAVE 1/4 E MAGN	1	66001616	415,280 €
	63600001	SET CHIAVI A BUSSOLA 1/4 E			
	63600005	SET CHIAVI A BUSSOLA 1/4 E MAGNETICHE			
	63004	CHIAVE 1/4 E MAGN	2	66001617	551,140 €
	63010	CHIAVE 1/4 E CON SFERA X INOX			
	63011	CHIAVE 1/4 E IMPACT MAGN.			
	63600001	SET CHIAVI A BUSSOLA 1/4 E			
	63600005	SET CHIAVI A BUSSOLA 1/4 E MAGNETICHE			
ACCESSORI ACCESSORI	65014001	CHIAVE UNIVERSALE X CENTRALINE	1	66001618	406,700 €
	64221020	MINI CRICCHETTO Q 1/4 X 1/4 C			
	64221030001	MINI CRICCHETTO PORTAINSERI REVERSIBILE			
	64221001	CRICCHETTO DA PALMO CON INSERTI			
	62025005001	BUSSOLA PORTAINSERI 1/4 X 1/4			
	62173005001	PROLUNGA CROMATA 1/4 X 1/4			
	62034010	RINVIO ANGOLARE 90° 1/4 X 1/4C	1	66001619	357,360 €
	62034025	RINVIO ANGOLARE 80° PER INSERTI			
	65006047	MINI GIRAVITE CRICCHETTO CON INSERTI			
	65006050	GIRAVITE PORTAINSERI CRICCHETTO CON INSERTI			
62029005	GIRAVITE PORTAINSERI MAGNETICO				

1

2

3

4

CATEGORIA MERCEOLOGICA CATEGORIA MERCEOLOGICA	COD. FAMIGLIA COD. FAMIGLIA	DESCRIZIONE ARTICOLO DESCRIZIONE ARTICOLO	N. MODULI N. MODULI	COD. MODULO COD. MODULO	LISTINO € LISTINO €
ACCESSORI ACCESSORI	65101	SET CHIAVI MASCHIO	2	66001620	769,560 €
	62034015	RINVIO ANGOLARE 80° CON MANICO X 1/4C			
	62034010	RINVIO ANGOLARE 90° 1/4 X 1/4C			
	64221020	MINI CRICCHETTO Q 1/4 X 1/4 C			
	66037010	SET ESTRATTORI PER VITI			
CHIAVI DI MANOVRA CHIAVI DI MANOVRA	65201	CHIAVI COMBinate CH.	3	66001621	733,840 €
	65210	CHIAVI COMBinate CRICCH.-SNODO	1	66001622	877,390 €
	65208	CHIAVI COMBinate A CRICCHETTO	1	66001623	671,940 €
BUSSOLE BUSSOLE	64008	BUSSOLA CROM. Q 1/4 CH.	4	66001624	978,680 €
	64048	BUSSOLA CROM. Q 1/2 CH.			
	65999002	GIRAVITE PORTABUSSOLE X 1/4"			
	64221005	CRICCHETTO 1/4 REVERSIBILE			
	64221020	MINI CRICCHETTO Q 1/4 X 1/4 C			
	64224005	CRICCHETTO 1/2 REVERSIBILE			
GIRAVITI GIRAVITI	65001	GIRAVITE TAGLIO	3	66001625	946,430 €
	65002	GIRAVITE TAGLIO DRITTO			
	65003	GIRAVITE CROCE PH			
	65004	GIRAVITE CROCE PZ			
	65005	GIRAVITE TX F			

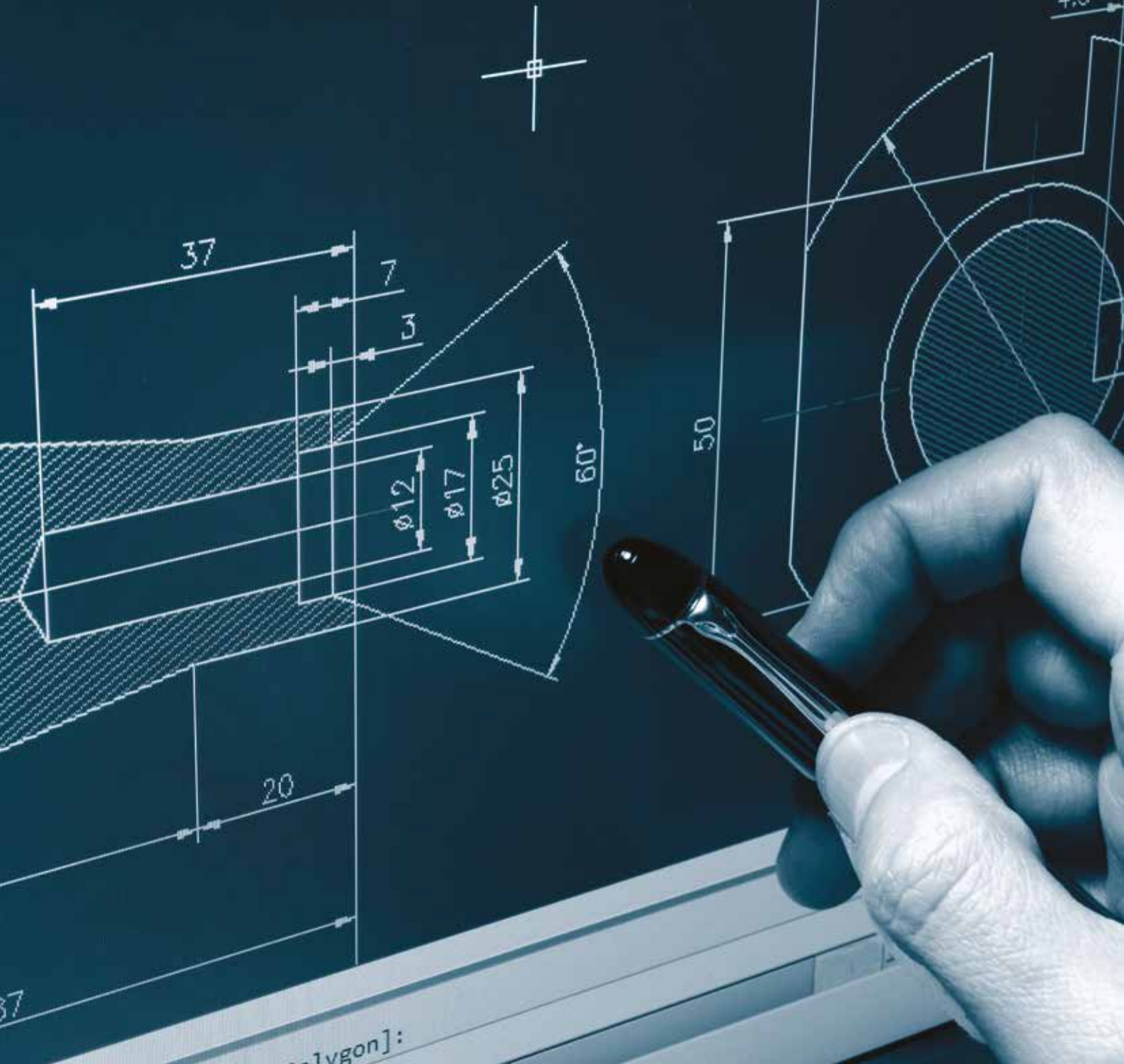

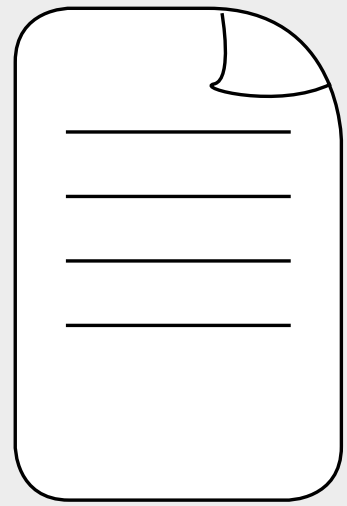
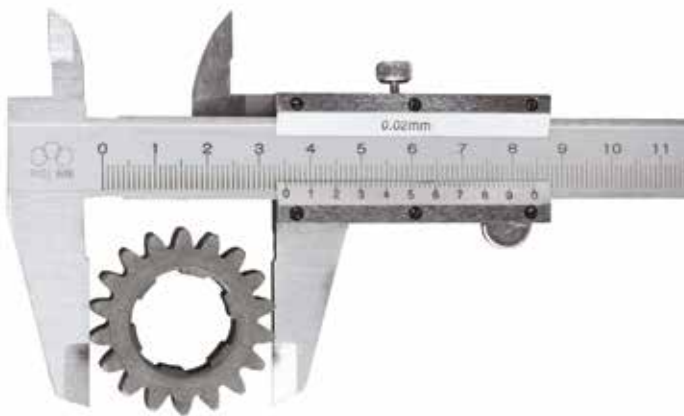

L'attenzione ai dettagli che da sempre contraddistingue il marchio LTI si riflette anche nel supporto alla clientela: nelle seguenti pagine vogliamo guidarvi nell'utilizzo dei nostri prodotti in maniera semplice ma allo stesso tempo fornendovi una panoramica precisa e dettagliata. Le nostre schede tecniche sono lo strumento perfetto per approcciarsi a qualsiasi tipo di operazione in sicurezza e con la tranquillità di aver scelto lo strumento più adatto per il conseguimento del risultato ottimale.

The attention to detail that has always distinguished the LTI brand is also reflected in the customer support. The following pages will guide you on how to use our products in a simple way and also provide you with accurate and detailed information. Our technical datasheets are the perfect tool to help you carry out any type of operation safely and with the certainty of having chosen the right tool for the best results.



SCHEDE TECNICHE TECHNICAL DATASHEETS

INSERTI *BITS*

	PHILLIPS®	p. 476
	POZIDRIV®	p. 477
	TORX®	p. 478
	TORX-PLUS®	p. 479
	ESAGONO	p. 480
	TAGLIO	p. 481

BUSSOLE *SOCKETS*

	TORX®	p. 482
	ESAGONO	p. 483

ATTACCHI *DRIVES*

 		p. 484
---	--	--------



SCHEDE TECNICHE TECHNICAL DATASHEETS

PHILLIPS®

A REGISTERED TRADEMARK OF PHILLIPS SCREW COMPANY



IN ACCORDO A NORME INTERNAZIONALI
IN ACCORDANCE WITH INTERNATIONAL STANDARDS

COPPIA DI TORSIONE SECONDO NORME
TIGHTENING TORQUE IN ACCORDANCE WITH THE STANDARDS

**DIN 5260
ISO 8764**

**DIN 5261*
ISO 8764***

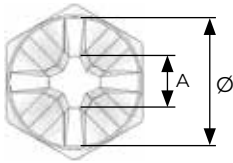

					Autofilettanti per metallo Self-tapping for metal			Autofilettanti per legno Self-tapping for wood			Metriche Metrics		
	A	Ø	Nm	Nm	ISO 7049 = DIN 7981	ISO 7050 = DIN 7982	ISO 7051 = DIN 7983	DIN 7996	DIN 7997	DIN 7995	ISO 7045 = DIN 7985	ISO 7046 = DIN 965	ISO 7047 = DIN 966
PH0	0,84	3	1,0	1,0	2,2	2,2	2,2	2,0	2,0	2,0	2,0	2,0	2,0
PH1	1,30	4,5	3,5	3,8	2,2 2,9	2,2 2,9	2,2 2,9	2,5 3,0	2,5 3,0	2,5 3,0	2,5 3,0	2,5 3,0	2,5 3,0
PH2	2,31	6	8,2	10,3	3,5 4,8	3,5 4,8	3,5 4,8	3,5 5,0	3,5 5,0	3,5 5,0	4,0 5,0	4,0 5,0	4,0 5,0
PH3	3,84	8	19,5	32,0	5,5 6,3	5,5 6,3	5,5 6,3	5,5 7,0	5,5 7,0	5,5 7,0	6,0	6,0	6,0
PH4	5,11	10	38,0	88,7	8,0 9,5	8,0 9,5	8,0 9,5	8,0	8,0	8,0	8,0 10,0	8,0 10,0	8,0 10,0

* LE NORME PREVEDONO CHE SOTTO IL VALORE DI COPPIA INDICATA IL PROFILO DELL'UTENSILE NON PRESENTI ALCUNA DEFORMAZIONE

* THE STANDARDS REQUIRE THAT THE TOOL PROFILE DOES NOT DEFORM UNDER THE INDICATED TORQUE VALUES



IN ACCORDO A NORME INTERNAZIONALI
IN ACCORDANCE WITH INTERNATIONAL STANDARDS

COPPIA DI TORSIONE SECONDO NORME
TIGHTENING TORQUE IN ACCORDANCE WITH THE STANDARDS

**DIN 5260
ISO 8764**

**DIN 5261*
ISO 8764***



1:1

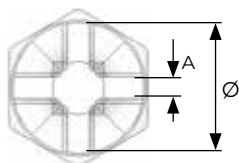

					Autofilettanti per metallo Self-tapping for metal			Autofilettanti per legno Self-tapping for wood			Metriche Metrics		
	A	Ø	 Nm	 Nm	ISO 7049 = DIN 7981	ISO 7050 = DIN 7982	ISO 7051 = DIN 7983	DIN 7996	DIN 7997	DIN 7995	ISO 7045 = DIN 7985	ISO 7046 = DIN 965	ISO 7047 = DIN 966
PZ0	0,45	3	1,0	1,0	2,2	2,2	2,2	2,0	2,0	2,0	2,0	2,0	2,0
PZ1	0,71	4,5	3,5	3,8	2,2 2,9	2,2 2,9	2,2 2,9	2,5 3,0	2,5 3,0	2,5 3,0	2,5 3,0	2,5 3,0	2,5 3,0
PZ2	1,00	6	8,2	10,3	3,5 4,8	3,5 4,8	3,5 4,8	3,5 5,0	3,5 5,0	3,5 5,0	4,0 5,0	4,0 5,0	4,0 5,0
PZ3	1,38	8	19,5	32,0	5,5 6,3	5,5 6,3	5,5 6,3	5,5 7,0	5,5 7,0	5,5 7,0	6,0	6,0	6,0
PZ4	2,10	10	38,0	88,7	8,0 9,5	8,0 9,5	8,0 9,5	8,0	8,0	8,0	8,0 10,0	8,0 10,0	8,0 10,0

* LE NORME PREVEDONO CHE SOTTO IL VALORE DI COPPIA INDICATA IL PROFILO DELL'UTENSILE NON PRESENTI ALCUNA DEFORMAZIONE

* THE STANDARDS REQUIRE THAT THE TOOL PROFILE DOES NOT DEFORM UNDER THE INDICATED TORQUE VALUES

SCHEDE TECNICHE TECHNICAL DATASHEETS

TORX®

A REGISTERED TRADEMARK OF ACCUMENT GLOBAL TECHNOLOGIES



IN ACCORDO A NORME INTERNAZIONALI
IN ACCORDANCE WITH INTERNATIONAL STANDARDS

COPPIA DI TORSIONE SECONDO NORME
TIGHTENING TORQUE IN ACCORDANCE WITH THE STANDARDS

TMD-702

TMD-702*

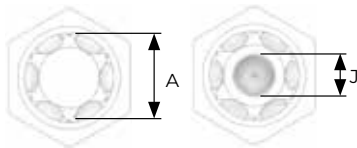

			Autofilettanti per metallo Self-tapping for metal			Autofilettanti per legno Self-tapping for wood			Metriche Metrics					

	A	J	 Nm	 Nm	 Nm	ISO 7049 = DIN 7981	ISO 7050 = DIN 7982	ISO 7051 = DIN 7983	DIN 7996	DIN 7997	DIN 7995	ISO 7045 = DIN 7985	ISO 7046 = DIN 965	ISO 7047 = DIN 966	DIN 912 7984 6912	ISO 4762 = DIN 912	ISO 10642 = DIN 7991
TX03	1,12			0,25								1,2	1,4	1,4	1,2		
TX04	1,30			0,37													
TX05	1,37		0,43	0,51								1,4 1,6	1,8		1,4 1,6		
TX06	1,65		0,75	0,91		2,2	2,2					1,3 2,0	2,0		1,3 2,0		
TX07	1,97		1,4	1,7													
TX08	2,30	0,74	2,2	2,6	2,2	2,9	2,9	2,9				2,5	2,5	2,5		2,5	
TX09	2,48	0,81	2,8	3,4	2,9	2,9											
TX10	2,27	0,94	3,7	4,5	3,8	3,5	3,5	3,5	3,0	3,0		3,0	3,0	3,0	3,0	3,0	3,0
TX15	3,26	1,19	6,4	7,7	6,5	3,9	3,9	3,9	3,5	3,5		3,5	3,5	3,5	3,5		
TX20	3,84	1,57	10,5	12,7	10,8	4,2	4,2	4,2	4,0 4,5	4,0 4,5	4,5	4,0	4,0	4,0	4,0	4,0	4,0
TX25	4,40	1,96	15,9	19,0	16,1	4,8 5,5	4,8 5,5	4,8 5,5	4,5 6,0	4,5 5,0	4,5	5,0	5,0	5,0	4,0 5,0	5,0	5,0
TX27	4,96	2,21	22,5	26,9	22,9										4,3 5,0		
TX30	5,49	2,72	31,1	37,4	31,8	6,3	6,3	6,3	6,0	6,0		6,0	6,0	6,0	6,0	6,0	6,0
TX40	6,60	3,15	54,1	65,1	55,3	8,0				8,0 10,0		8,0	8,0	8,0	8,0		8,0
TX45	7,77	3,40	86,0	104,0	88,0											8,0	
TX50	8,79	3,73	132,0	159,0	135,0	10,0						10,0	10,0	10,0	10,0	10,0	10,0
TX55	11,17	4,75		257,0	218,0	12,0									12,0	12,0	
TX60	13,20	5,56		445,0	379,0										14,0	14,0	
TX70	15,49	6,73		701,0	596,0												

* PER QUESTO PROFILO I VALORI DI COPPIA INDICATI CORRISPONDONO AL VALORE MINIMO DI ROTTURA
* THE TORQUE VALUES INDICATED FOR THIS PROFILE CORRESPOND TO THE MINIMUM BREAKING VALUE



IN ACCORDO A NORME INTERNAZIONALI
IN ACCORDANCE WITH INTERNATIONAL STANDARDS

COPPIA DI TORSIONE SECONDO NORME
TIGHTENING TORQUE IN ACCORDANCE WITH THE STANDARDS

NMD-702
NMD-602

NMD-702*
NMD-602*

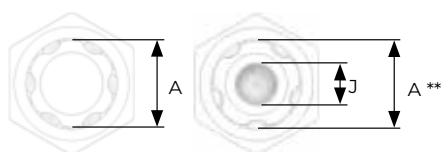

** DIAMETRO CIRCOSCRITTO · ** CIRCUMSCRIBED DIAMETER ·

		Autofilettanti per metallo Self-tapping for metal			Metriche Metrics												
	A		Nm		A	J		Nm	ISO 7049 = DIN 7981	ISO 7050 = DIN 7982	ISO 7051 = DIN 7983	ISO 7045 = DIN 7985	ISO 7046 = DIN 965	ISO 7047 = DIN 966	DIN 912 = 7984 = 6912	ISO 4762 = DIN 912	ISO 10642 = DIN 7991
10IP	2,72	5,42		10IPR	2,72	0,91	4,3		3,5	3,5	2,9 3,5	3,0	3,0	3,0	3,0	3,0	5,0
15IP	3,25	9,62		15IPR	3,25	1,17	7,3		3,9	3,9	3,5 3,9	3,5	3,5 4,0	3,5			6,0
20IP	3,84	16,15		20IPR	3,84	1,55	11,9		4,2	4,2	4,2	4,0	4,0 5,0	4,0	4,0	4,0	6,0
25IP	4,39	23,50		25IPR	4,39	1,93	17,4		4,8 5,5	4,8 5,5	4,8 5,5	5,0	5,0 6,0	5,0	5,0	5,0	7,0 8,0
27IP	4,95	34,62		27IPR	4,95	2,18	25,1										8,0
30IP	5,49	47,18		30IPR	5,49	2,57	33,5		6,3	6,3	6,3	6,0	6,0	6,0	8,0	6,0	
40IP	6,60	82,08		40IPR	6,60	2,92	59,4				8,0		8,0	8,0	8,0	8,0	10,0

* PER QUESTO PROFILO I VALORI DI COPPIA INDICATI CORRISPONDONO AL VALORE MINIMO DI ROTTURA

* THE TORQUE VALUES INDICATED FOR THIS PROFILE CORRESPOND TO THE MINIMUM BREAKING VALUE



SCHEDE TECNICHE TECHNICAL DATASHEETS

ESAGONO



IN ACCORDO A NORME INTERNAZIONALI
IN ACCORDANCE WITH INTERNATIONAL STANDARDS

COPPIA DI TORSIONE SECONDO NORME
TIGHTENING TORQUE IN ACCORDANCE WITH THE STANDARDS

DIN 911
DIN 7426

DIN 7426*
ISO 2936*

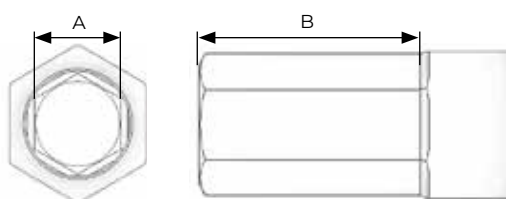

Ø	A	B _{MIN}	Nm	Nm	Metriche Metrics				
					DIN 7984	ISO 4762 = DIN 7984	ISO 10642 = DIN 7991	DIN 908	DIN 913 914 DIN 915 916
0,7	0,7	1,6	0,08						1,4 1,8
0,9	0,9	1,8	0,18						2,0
1,3	1,3	2,0	0,53			1,4			2,5
1,5	1,5	2,3	0,82	0,95		1,6 2,0			3,0
2,0	2,0	3,0	1,9	2,3	3,0	2,5	3,0		4,0
2,5	2,5	3,8	3,4	4,4	4,0	3,0	4,0		5,0
3,0	3,0	4,5	6,6	7,6	5,0	4,0	5,0		6,0
4,0	4,0	6,0	16,0	18,0	6,0	5,0	6,0		8,0
5,0	5,0	7,5	30,0	35,0	8,0	6,0	8,0	10,0	10,0
6,0	6,0	9,0	52,0	61,0		8,0	10,0	12,0 14,0	12,0 14,0
7,0	7,0	10,5	78,0	97,0	10,0				
8,0	8,0	12,0	120,0	140,0	12,0	10,0	12,0	16,0 18,0	16,0 18,0
10,0	10,0	16,0	220,0	280,0	14,0	12,0	14,0 16,0	20,0 22,0	20,0 22,0
12,0	12,0	18,0	370,0	480,0	16,0 18,0	14,0	18,0 20,0	24,0 26,0	24,0 26,0
14,0	14,0	25,0	590,0		20,0 22,0	16,0 18,0	22,0 24,0		

* LE NORME PREVEDONO CHE SOTTO IL VALORE DI COPPIA INDICATA IL PROFILO DELL'UTENSILE NON PRESENTI ALCUNA DEFORMAZIONE

* THE STANDARDS REQUIRE THAT THE TOOL PROFILE DOES NOT DEFORM UNDER THE INDICATED TORQUE VALUES

TAGLIO



IN ACCORDO A NORME INTERNAZIONALI
IN ACCORDANCE WITH INTERNATIONAL STANDARDS

COPPIA DI TORSIONE SECONDO NORME
TIGHTENING TORQUE IN ACCORDANCE WITH THE STANDARDS

DIN-ISO 2380

DIN-ISO 2380*

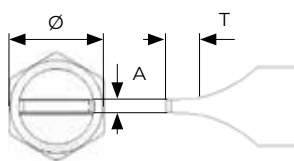

Autofilettanti per metallo <i>Self-tapping for metal</i>			Autofilettanti per legno <i>Self-tapping for wood</i>			Metriche <i>Metrics</i>				

Ø	A	T	Nm	Nm	ISO 1481 = DIN 7971	ISO 1482 = DIN 7972	ISO 1483 = DIN 7973	DIN 96	DIN 97	DIN 95	ISO 1207 = DIN 84	ISO 1580 = DIN 85	ISO 2009 = DIN 963	ISO 2010 = DIN 964	ISO 4766 7435 = DIN 417-427
1,5	0,30	0,50		0,15											
1,8	0,37	0,50		0,28							1,2 1,4				
2,0	0,40	0,70	0,3	0,35				1,6	1,6				1,6		2,5 3,0
2,5	0,40	0,70	0,4	0,45				2,0		1,6	1,6 1,8			1,6	3,5
3,0	0,50	0,90	0,7	0,8		2,2	2,2		2,0	2,0	2,0		2,0	2,0	4,0
3,5	0,60	1,10	1,3	1,4	2,2			2,5	2,5	2,5	2,5		2,5	2,5	
4,0	0,50	0,90		1,1				2,0							
4,0	0,80	1,40	2,6	2,9	2,9	2,9	2,9	3,0 3,5	3,0 3,5	3,0 3,5	3,0	3,0	3,0 3,5	3,0 3,5	5,0 6,0
4,5	0,60	1,10		1,8	2,2			2,5			2,5				
5,0	0,80	1,40	3,2	3,6											
5,5	0,80	1,40	3,5	3,9				3,5		3,5	3,0	3,5	3,5	3,5	
5,5	1,00	1,80	5,5	6,2	3,5 3,9	3,5 3,9	3,5 3,9	4,0 4,5	4,0 4,5	4,0 4,5	3,5	3,5	4,0	4,0	
6,0	1,00	1,80		6,7											
6,5	1,20	2,20	9,4	10,5		4,2 4,8	4,2	5,0 5,5	5,0	5,0	4,0		5,0	5,0	8,0
7,0	1,20	2,20	10,0	11,3											
8,0	1,20	2,20	11,5	12,9	4,2		4,8		5,5	5,5	5,0	4,0			
8,0	1,60	2,90	20,5	22,9	4,8	5,5 6,3	5,5	6,0	6,0	6,0		5,0	6,0	6,0	10,0 12,0
10,0	1,60	2,90	25,6	28,7	5,5 6,3		6,3		7,0 8,0	7,0	6,0				14,0
13,0	2,00	3,60	52,0	58,0				8,0	10,0		8,0	8,0	8,0	8,0	16,0

* LE NORME PREVEDONO CHE SOTTO IL VALORE DI COPPIA INDICATA IL PROFILO DELL'UTENSILE NON PRESENTI ALCUNA DEFORMAZIONE

* THE STANDARDS REQUIRE THAT THE TOOL PROFILE DOES NOT DEFORM UNDER THE INDICATED TORQUE VALUES

SCHEDE TECNICHE

TECHNICAL DATASHEETS

TORX®

A REGISTERED TRADEMARK OF ACCUMENT GLOBAL TECHNOLOGIES



IN ACCORDO A SPECIFICA ACCUMENT GLOBAL TECHNOLOGIES
IN ACCORDANCE WITH THE SPECIFICATIONS OF ACCUMENT GLOBAL TECHNOLOGIES



Metriche
Metrics



	A	Metriche Metrics	
		ISO 4014 - 4017 = DIN 931 - 933	ISO 8100 = DIN 6921
	A		
E5	4,72	4,0	
E6	5,69	5,0	4,0
E7	6,17		
E8	7,47	6,0 7,0	5,0
E10	9,37	8,0	6,0
E11	10,03		
E12	11,12	10,0 11,0	8,0
E14	12,85	12,0	10,0
E16	14,71		
E18	16,64	14,0	12,0
E20	18,41	16,0	14,0
E22	20,24		
E24	22,09	18,0 20,0	

ESAGONO



IN ACCORDO A NORME INTERNAZIONALI
IN ACCORDANCE WITH INTERNATIONAL STANDARDS

COPPIA DI TORSIONE SECONDO NORME
TIGHTENING TORQUE IN ACCORDANCE WITH THE STANDARDS

DIN 3129

DIN-ISO 1711*













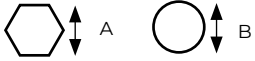





























			Autofilettanti per metallo <i>Self-tapping for metal</i>	Autofilettanti per legno <i>Self-tapping for wood</i>	Metriche <i>Metrics</i>		
	 Nm	 Nm	ISO 1479 = DIN 7976	DIN 571	ISO 4014 4016 4017	ISO 4035 4036 = DIN 439	ISO 4032 4033 = DIN 934
4		10,4			2,0	2,0	2,0
4,5		12,6			2,3		
5	11,5	15,1	2,9		2,5	2,5	2,5
5,5	14,4	17,8	3,5		3,0	3,0	3,0
6	17,6	23,2			3,5	3,5	3,5
7	25,2	33,2	3,9 4,2	4,0	4,0	4,0	4,0
8*	34,5	94,1	4,8 5,5	5,0	5,0	5,0	5,0
9*	45,4	119,2					
10*	58,1	147,0	6,3	6,0	6,0	6,0	6,0
11*	72,7	178,0			7,0		7,0
12*	89,1	212,0		7,0			
13*	107,0	249,0	8,0	8,0	8,0	8,0	8,0
14*	128,0	288,0					

* VALUTARE ANCHE RESISTENZA ATTACCO

* ALSO EVALUATE ATTACHMENT RESISTANCE

ATTACCHI MASCHIO STANDARD, APPLICAZIONI, RESISTENZE

STANDARD MALE ATTACHMENTS, APPLICATIONS, RESISTANCES

			APPLICAZIONE APPLICATION	STANDARDS	Nm
	A=3mm			DIN 3126 Form A3	7,6
	A=4mm - 5/32"			DIN 3126 Form C4	18,0
	A=5,5mm			DIN 3126 Form A5,5	47,0
	B=VARIE			LTI	N.A.
	B=7mm			LTI	N.A.
	A=6,35mm - 1/4"			DIN 3126 Form C6,3	71,0
	A=6,35mm - 1/4"			DIN 3126 Form E6,3	71,0
	A=7,93mm - 5/16"			DIN 3126 Form C8	144,0
	A=7,93mm - 5/16"			FIAM-DESOUTTER	144,0
	A=9,52mm - 3/8"			AUTOMOTIVE	280,0
	A=11,2mm - 7/16"			DIN 3126 Form E11,2	396,0
	B=M4x0,7			ISO 724 - DIN 13.1	7,0
	B=M5x0,8			ISO 724 - DIN 13.1	18,0
	B=M6x1			ISO 724 - DIN 13.1	25,0
	B=10x32 UNF			ISO 724 - DIN 13.1	18,0
	B=BSF 3/16x32 Whitworth			ISO 724 - DIN 13.1	18,0

ATTACCHI QUADRO STANDARD, APPLICAZIONI, RESISTENZE

STANDARD SQUARE ATTACHMENTS, APPLICATIONS, RESISTANCES

			APPLICAZIONE APPLICATION	STANDARDS	Nm
	A=6,35mm - 1/4"			DIN 3121 Form G6,3	68,6
	A=9,52mm - 3/8"			DIN 3121 Form G10	225,0
	A=12,70mm - 1/2"			DIN 3121 Form G12,5	569,0
	A=19,05mm - 3/4"			DIN 3121 Form H20	1569,0
	A=25,40mm - 1"			DIN 3121 Form H25	2795,0
	A=38,10mm - 1-1/2"			DIN 3121 Form H40	

			APPLICAZIONE APPLICATION	STANDARDS	Nm
	A=6,35mm - 1/4"			DIN 3121 Form G6,3	62,0
	A=9,52mm - 3/8"			DIN 3121 Form G10	202,0
	A=12,70mm - 1/2"			DIN 3121 Form G12,5	512,0
	A=19,05mm - 3/4"			DIN 3121 Form D20	1412,0

INDICE PER CODICE PROGRESSIVO

INDEX FOR PROGRESSIVE CODES

61001	p. 150	61060	p. 125	61124	p. 163
61002	p. 153	61061	p. 258	61125	p. 162
61003	p. 153	61062	p. 260	61126	p. 149
61004	p. 152	61063	p. 262	61127	p. 242
61006	p. 151	61064	p. 266	61128	p. 242
61007	p. 152	61065	p. 264	61129	p. 240
61008	p. 247	61066	p. 270	61130	p. 235
61010	p. 268	61067	p. 166	61132	p. 164
61011	p. 240	61068	p. 271	61133	p. 160
61012	p. 267	61069	p. 138	61134	p. 160
61021	p. 154	61070	p. 140	61135	p. 161
61022	p. 156	61071	p. 104	61136	p. 163
61023	p. 155	61072	p. 140	61137	p. 162
61024	p. 247	61073	p. 141	61138	p. 164
61025	p. 156	61075	p. 138	61139	p. 147
61026	p. 105	61076	p. 139	61140	p. 251
61027	p. 167	61077	p. 246	61142	p. 251
61028	p. 167	61078	p. 104	61143	p. 251
61029	p. 158	61080	p. 268	61144	p. 252
61030	p. 159	61081	p. 126	61146	p. 252
61031	p. 270	61082	p. 141	61147	p. 165
61035	p. 258	61083	p. 68	61200	p. 56
61036	p. 260	61084	p. 68	61201	p. 56
61037	p. 262	61085	p. 126	61210	p. 53
61038	p. 266	61090	p. 264	61211	p. 53
61039	p. 264	61091	p. 258	61220	p. 54
61040	p. 270	61092	p. 261	61221	p. 54
61041	p. 166	61093	p. 262	61230	p. 55
61042	p. 271	61094	p. 142	61231	p. 55
61043	p. 132	61095	p. 105	61250	p. 79
61044	p. 135	61097	p. 143	61251	p. 79
61045	p. 103	61099	p. 248	61260	p. 80
61046	p. 132	61100	p. 241	61261	p. 80
61047	p. 135	61101	p. 146	61270	p. 81
61048	p. 136	61102	p. 146	61271	p. 81
61049	p. 125	61103	p. 69	61305	p. 93
61051	p. 133	61104	p. 69	61310	p. 91
61052	p. 103	61110	p. 260	61311	p. 91
61053	p. 246	61111	p. 144	61320	p. 92
61055	p. 268	61113	p. 145	61321	p. 92
61056	p. 136	61114	p. 241	61330	p. 93
61057	p. 137	61121	p. 148	61355	p. 33
61058	p. 67	61122	p. 161	61356	p. 33
61059	p. 67	61123	p. 148	61365	p. 34

61366		p. 34
61375		p. 35
61376		p. 35
61400		p. 116
61405		p. 117
61410		p. 115
61420		p. 115
61430		p. 116
61450		p. 41
61451		p. 41
61460		p. 42
61461		p. 42
61470		p. 43
61471		p. 43
62001	62001005	p. 256
	62001010	p. 256
	62001015	p. 257
	62001000	p. 257
62005		p. 259
62006		p. 261
62007		p. 263
62008		p. 266
62009		p. 265
62011		p. 213
62012		p. 202
62013		p. 201
62014		p. 212
62015	62015005	p. 201
	62015010	p. 201
	62015015	p. 201
	62015020	p. 201
	62015025	p. 201
	62015030	p. 201
	62015035	p. 201
	62015040	p. 201
	62015070	p. 201
	62015105	p. 118 - 202
62016	62016005	p. 204
	62016010	p. 204
	62016015	p. 204
	62016020	p. 204
	62016025	p. 204
	62016030	p. 204
	62016035	p. 204
	62016105	p. 118 - 205
	62016999	p. 212
62017		p. 208
62018	62018005	p. 203
	62018010	p. 204
62019	62019010	p. 206
	62019015	p. 207 - 222
	62019020	p. 207
	62019030	p. 205
	62019033	p. 205
	62019035	p. 205
62020	62020005	p. 208
	62020010	p. 208
	62020015	p. 209
62022		p. 213
62023		p. 217
62024		p. 213
62025		p. 217
62027		p. 218
62028		p. 219
62029	62029005	p. 216
	62029030	p. 216
	62029010	p. 216
	62029015	p. 223
62030		p. 219
62031		p. 220
62032		p. 215
62033		p. 215
62034	62034006	p. 225
	62034010	p. 225
	62034015	p. 227
	62034020	p. 226
	62034025	p. 227
62035		p. 57 - 203
62036		p. 206
62042		p. 271
62051		p. 223
62053		p. 226
62054		p. 223
62055		p. 222
62063		p. 249
62064		p. 250
62068		p. 269
62081		p. 243
62082		p. 243
62083		p. 243
62085		p. 267
62086		p. 209
62100		p. 229
62101		p. 229
62102		p. 232
62103		p. 231
62104	62104001	p. 347
	62104005	p. 287
	62104010	p. 287
62111		p. 230
62112		p. 232
62113		p. 231
62114		p. 232
62115		p. 329
62116	62116001	p. 369
	62116005	p. 298
	62116010	p. 298
	62116015	p. 298
	62116025	p. 298
62121		p. 230
62122	62122005	p. 231
	62122101	p. 277
62124	62124001	p. 347
	62124002	p. 347
	62124005	p. 287
	62124010	p. 287
62126	62126001	p. 373
	62126005	p. 310
	62126010	p. 310
	62126015	p. 310
62135	62135001	p. 369
	62135005	p. 298
62137		p. 315
62141		p. 310
62142		p. 317
62145		p. 315
62151		p. 276
62152		p. 276
62155		p. 274
62173		p. 328
62174		p. 328
62180		p. 277

INDICE PER CODICE PROGRESSIVO

INDEX FOR PROGRESSIVE CODES

62181	p. 286
62182	p. 287
62183	p. 286
62184	p. 286
62185	p. 346
62186	p. 346
62191	p. 297
62192	p. 298
62193	p. 297
62195	p. 368
62196	p. 368
62205	p. 309
62206	p. 310
62207	p. 309
62208	p. 373
62209	p. 373
62211	p. 314
62212	p. 314
62215	p. 317
62216	p. 317
62601	p. 233
62602	p. 374
63001	p. 190
63002	p. 188
63003	p. 191
63004	p. 188
63005	p. 192
63006	p. 189
63008	p. 269
63010	p. 189
63011	p. 193
63011002	p. 193
63012	p. 192
63014	p. 275
63015	p. 272
63016	p. 272
63021	p. 273
63022	p. 273
63025	p. 274
63600	63600001 p. 194
	63600005 p. 194
	63600016 p. 195
64008	p. 321
64008201	p. 321
64009	p. 322
64009201	p. 322
64010	p. 323
64010201	p. 323
64011	p. 281
64011201	p. 281
64013	p. 282
64015	p. 283
64017	p. 283
64026	p. 334
64026201	p. 334
64027	p. 335
64027201	p. 335
64028	p. 336
64028201	p. 336
64029	p. 337
64029201	p. 337
64030	p. 338
64030201	p. 338
64031	p. 288
64031301	p. 288
64033	p. 289
64033301	p. 289
64034	p. 290
64035	p. 291
64040	p. 291
64048	p. 352
64048201	p. 352
64051	p. 353
64051201	p. 354
64052	p. 355
64052201	p. 355
64053	p. 357
64053201	p. 356
64054	p. 357
64054201	p. 357
64061	p. 306
64061401	p. 307
64063	p. 308
64065	p. 372
64065301	p. 372
64071	p. 312
64072	p. 313
64081	p. 316
64086	p. 339
64086201	p. 339
64088	p. 340
64101	p. 300
64102	p. 301
64103	p. 302
64104	p. 302
64105	p. 303
64106	p. 304
64107	p. 305
64108	p. 305
64125	p. 284
64126	p. 291
64127	p. 324
64127201	p. 324
64128	p. 340
64129	p. 358
64129201	p. 358
64131	p. 285
64132	p. 285
64133	p. 284
64135	p. 294
64136	p. 294
64137	p. 292
64137301	p. 292
64138	p. 293
64138301	p. 293
64139	p. 309
64145	p. 327
64147	p. 326
64148	p. 327
64149	p. 325
64150	p. 325
64151	p. 326
64161	p. 341
64162	64162005 p. 342
	64162100 p. 343
64163	p. 341
64163201	p. 342
64171	p. 359
64172	p. 360
64173	p. 361
64174	p. 364
64175	p. 362
64176	p. 363
64177	64177003 p. 365
	64177004 p. 365
	64177005 p. 365
	64177006 p. 365
	64177011 p. 366

	64177012	p. 366		64230024	p. 388		65015	p. 427
	64177015	p. 366		64230026	p. 389		65022	p. 410
	64177016	p. 366		64230030	p. 390		65023	p. 410
	64177021	p. 367		64230045	p. 391		65024	p. 411
	64177022	p. 367		64230299	p. 396		65026	65026005 p. 412
	64177025	p. 367		64230303	p. 393			65026010 p. 412
	64177026	p. 367		64230304	p. 395			65026015 p. 412
64181		p. 295		64230320	p. 397		65031	p. 428
64182		p. 296		64230322	p. 398		65032	p. 430
64183		p. 295		64230400	p. 459		65033	p. 432
64184		p. 295		64230510	p. 457		65034	p. 428
64185		p. 296		64230515	p. 458		65035	p. 430
64200		p. 345		64230615	p. 416		65036	p. 432
64201		p. 344		64230630	p. 416		65041	p. 429
64202		p. 344	64300		p. 375		65042	p. 431
64220	64220005	p. 329	64330	64330002	p. 290		65043	p. 433
	64220105	p. 330	64999		p. 318		65044	p. 429
64221	64221001	p. 421	65001		p. 402		65045	p. 431
	64221005	p. 331	65002		p. 403		65046	p. 433
	64221006	p. 331	65003		p. 404		65051	p. 442
	64221010	p. 332	65004		p. 405		65052	p. 442
	64221015	p. 332	65005		p. 405 - 406		65053	p. 443
	64221020	p. 331	65006	65006005	p. 408		65054	p. 446
	64221030	p. 214		65006010	p. 408		65055	p. 446
64222		p. 348		65006015	p. 408		65101	65101001 p. 434
64223	64223005	p. 349		65006020	p. 408			65101002 p. 435
	64223006	p. 349		65006030	p. 419			65101003 p. 437
	64223010	p. 350		65006031	p. 419			65101011 p. 434
	64223015	p. 350		65006035	p. 418			65101012 p. 435
64224	64224001	p. 370		65006036	p. 418			65101013 p. 437
	64224005	p. 370		65006041	p. 425			65101014 p. 438
	64224006	p. 370		65006042	p. 424			65101015 p. 436
	64224010	p. 371		65006045	p. 420			65101016 p. 440
	64224015	p. 371		65006046	p. 420			65101017 p. 441
64225		p. 374		65006047	p. 421			65101031 p. 434
64230	64230001	p. 377		65006050	p. 422			65101032 p. 435
	64230005	p. 378		65006185	p. 413			65101033 p. 437
	64230008	p. 379		65006190	p. 414			65101034 p. 439
	64230009	p. 380		65006200	p. 248			65101035 p. 436
	64230010	p. 381	65007	65007005	p. 409			65101036 p. 440
	64230013	p. 382		65007010	p. 409			65101041 p. 434
	64230015	p. 383		65007015	p. 415			65101042 p. 435
	64230017	p. 384	65011	65011005	p. 233			65101043 p. 437
	64230018	p. 385		65011010	p. 234			65101045 p. 436
	64230020	p. 386		65011020	p. 234			65101100 p. 444
	64230022	p. 387	65014		p. 426			65101105 p. 444

INDICE PER CODICE PROGRESSIVO

INDEX FOR PROGRESSIVE CODES

	65101110	p. 444			
	65101120	p. 447			
	65101125	p. 447			
65200		p. 450			
65201		p. 448			
65203		p. 451			
65208		p. 452			
65210		p. 454			
65216		p. 456			
65300		p. 450			
65301	65301001	p. 449			
	65301002	p. 449			
	65301050	p. 456			
65303		p. 451			
65310	65310001	p. 453			
	65310002	p. 453			
65315	65315001	p. 455			
	65315002	p. 455			
65991	65991001	p. 461			
	65991003	p. 461			
	65991005	p. 462			
	65991015	p. 465			
	65991020	p. 462			
	65991021	p. 463			
	65991025	p. 463			
	65991030	p. 464			
	65991040	p. 464			
	65991100	p. 466			
	65991101	p. 466			
	65991102	p. 466			
	65991103	p. 466			
	65991110	p. 467			
65999	65999001	p. 411			
	65999002	p. 330			
66001	66001020	p. 185			
	66001025	p. 185			
	66001030	p. 185			
	66001035	p. 185			
	66001040	p. 185			
	66001045	p. 185			
	66001050	p. 111			
	66001051	p. 111			
	66001055	p. 62			
	66001056	p. 62			
	66001060	p. 75			
	66001061	p. 75			
	66001065	p. 87			
	66001070	p. 99			
	66001071	p. 99			
	66001075	p. 122			
	66001076	p. 122			
	66001080	p. 37			
	66001085	p. 49			
	66001105	p. 195			
	66001110	p. 333			
	66001115	p. 351			
	66001120	p. 211			
	66001300	p. 183			
	66001305	p. 63			
	66001310	p. 76			
	66001315	p. 88			
	66001320	p. 100			
	66001325	p. 112			
	66001340	p. 38			
	66001345	p. 50			
	66001501	p. 186			
	66001505	p. 64			
	66001510	p. 77			
	66001515	p. 89			
	66001520	p. 113			
	66001525	p. 101			
	66001530	p. 39			
	66001535	p. 51			
	66001600	p. 470			
	66001601	p. 470			
	66001602	p. 470			
	66001603	p. 470			
	66001604	p. 470			
	66001605	p. 470			
	66001606	p. 470			
	66001607	p. 470			
	66001608	p. 470 - 471			
	66001609	p. 471			
	66001610	p. 471			
	66001611	p. 471			
	66001612	p. 471			
	66001613	p. 472			
	66001614	p. 472			
	66001615	p. 472			
	66001616	p. 472			
	66001617	p. 472			
	66001618	p. 472			
	66001619	p. 472			
	66001620	p. 473			
	66001621	p. 473			
	66001622	p. 473			
	66001623	p. 473			
	66001624	p. 473			
	66001625	p. 473			
66002	66002105	p. 168			
	66002108	p. 169			
	66002110	p. 106			
	66002113	p. 106			
	66002115	p. 168			
	66002118	p. 169			
	66002125	p. 168			
	66002129	p. 169			
	66002130	p. 106			
	66002134	p. 106			
	66002150	p. 168			
	66002155	p. 168			
	66002160	p. 168			
	66002165	p. 168			
	66002170	p. 168			
	66002200	p. 58			
	66002204	p. 58			
	66002215	p. 58			
	66002219	p. 58			
	66002225	p. 58			
	66002229	p. 58			
	66002300	p. 70			
	66002304	p. 70			
	66002305	p. 70			
	66002309	p. 70			
	66002310	p. 70			
	66002314	p. 70			
	66002350	p. 82			
	66002354	p. 82			
	66002355	p. 82			
	66002359	p. 82			
	66002360	p. 82			
	66002364	p. 82			
	66002380	p. 94			
	66002384	p. 94			
	66002385	p. 94			
	66002389	p. 94			
	66002390	p. 94			
	66002394	p. 94			

	66002400	p. 119		66005385	p. 96		66007430	p. 45
	66002404	p. 119		66005389	p. 96		66007435	p. 45
	66002405	p. 119		66005400	p. 120	66009	66009005	p. 175
	66002409	p. 119		66005404	p. 120		66009009	p. 175
	66002430	p. 44		66005410	p. 120		66009015	p. 176
	66002434	p. 44		66005414	p. 120		66009019	p. 176
	66002435	p. 44		66005430	p. 46	66010	66010005	p. 178
	66002439	p. 44		66005434	p. 46		66010010	p. 110
	66002440	p. 44		66005435	p. 46		66010030	p. 74
	66002444	p. 44		66005439	p. 46		66010035	p. 86
	66002445	p. 36		66005505	p. 74		66010040	p. 98
	66002449	p. 36	66006	66006006	p. 174		66010045	p. 121
66005	66005105	p. 170		66006020	p. 172		66010050	p. 178
	66005109	p. 171		66006024	p. 173	66012		p. 177
	66005110	p. 108		66006030	p. 47	66013	66013005	p. 244
	66005114	p. 108		66006034	p. 47		66013010	p. 244
	66005115	p. 170		66006040	p. 109		66013015	p. 244
	66005119	p. 171		66006044	p. 109		66013016	p. 245
	66005125	p. 170		66006050	p. 172	66014	66014004	p. 179
	66005129	p. 171		66006054	p. 173		66014006	p. 180
	66005130	p. 108		66006055	p. 172		66014010	p. 181
	66005134	p. 108		66006059	p. 173		66014016	p. 182
	66005150	p. 170		66006060	p. 172	66015	66015001	p. 253
	66005154	p. 171		66006064	p. 173		66015010	p. 254
	66005155	p. 170		66006305	p. 73		66015011	p. 255
	66005160	p. 170		66006309	p. 73	66031	66031008	p. 210
	66005165	p. 170		66006310	p. 85		66031009	p. 210
	66005170	p. 170		66006314	p. 85		66031011	p. 210
	66005200	p. 60		66006320	p. 97		66031012	p. 210
	66005204	p. 61		66006324	p. 97		66031013	p. 210
	66005205	p. 60		66006500	p. 174		66031014	p. 210
	66005209	p. 61		66006510	p. 86		66031015	p. 210
	66005210	p. 60		66006515	p. 98		66031016	p. 210
	66005214	p. 61		66006520	p. 110		66031017	p. 210
	66005215	p. 60		66006525	p. 121		66031018	p. 210
	66005219	p. 61		66006530	p. 48	66036		p. 345
	66005300	p. 72	66007	66007100	p. 169	66037		p. 235
	66005304	p. 72		66007105	p. 169			
	66005305	p. 72		66007150	p. 107			
	66005309	p. 72		66007200	p. 59			
	66005310	p. 72		66007205	p. 59			
	66005314	p. 72		66007300	p. 71			
	66005350	p. 84		66007305	p. 71			
	66005354	p. 84		66007350	p. 83			
	66005380	p. 96		66007355	p. 83			
	66005384	p. 96		66007385	p. 95			



Richiesta di preventivo - *Get a quote*

inserti speciali - *special bits*

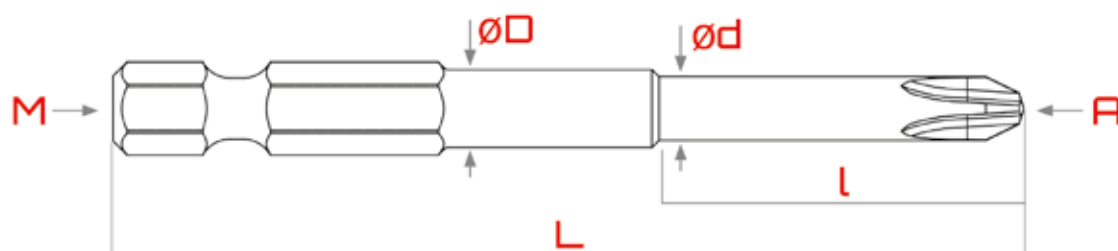
 fino a 400mm di lunghezza - *length up to 400mm*

Quantità/Quantity: _____

A: Punta/Tip

- | | |
|---|---|
| <input type="checkbox"/> Taglio | <input type="checkbox"/> TXH |
| <input type="checkbox"/> PH | <input type="checkbox"/> IP |
| <input type="checkbox"/> PZ | <input type="checkbox"/> IPR |
| <input type="checkbox"/> Esagonale
Hexagon | <input type="checkbox"/> altro/more _____ |
| <input type="checkbox"/> TX | |

Caratteristiche/Features

ØD: mm _____

Ød: mm _____

L: mm _____

L: mm _____

M: Attacco/Drive

- | | | | |
|---|---|---|--|
| <input type="checkbox"/> C (6,3mm) | <input type="checkbox"/> A (3mm) | <input type="checkbox"/> E (8mm) | <input type="checkbox"/> SPINA |
| <input type="checkbox"/> E (6,3mm) | <input type="checkbox"/> C (8mm) | <input type="checkbox"/> E (11,2mm) | <input type="checkbox"/> A (5,5mm) |
| <input type="checkbox"/> E (5mm)
JAPAN | <input type="checkbox"/> E (5mm)
WEBER | <input type="checkbox"/> (4mm)
HALF MOON | <input type="checkbox"/> HIOS (4mm) |
| | | | <input type="checkbox"/> altro/more: _____ |

Ulteriori specifiche/Further specifications: _____



Richiesta di preventivo - *Get a quote*

inserti filettati - *thread bits*

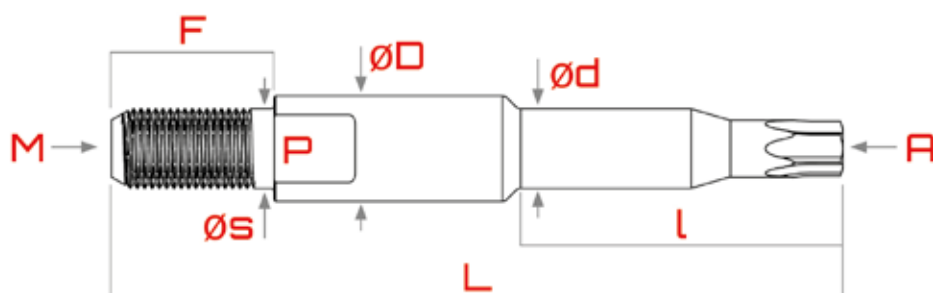
 fino a 400mm di lunghezza - *length up to 400mm*

Quantità/Quantity: _____

A: Punta/Tip

- | | | |
|--------------------------------------|--|---|
| <input type="checkbox"/> Taglio/Slot | <input type="checkbox"/> Esagonale/Hexagon | <input type="checkbox"/> IP |
| <input type="checkbox"/> PH | <input type="checkbox"/> TX | <input type="checkbox"/> IPR |
| <input type="checkbox"/> PZ | <input type="checkbox"/> TXH | <input type="checkbox"/> altro/more _____ |

M: Attacco/Drive

- Metric: mm _____
- UNF: mm _____
- Withworth: mm _____
- altro: mm _____

Caratteristiche/Features

- F: mm _____ L: mm _____
- ØD: mm _____ P: Piani chiave/Levels: _____
- Ød: mm _____ mm _____
- L: mm _____ ØS: mm _____

Ulteriori specifiche/Further specifications: _____



Magazzino di stoccaggio e produzione LTI in sito Krino.
LTI customized products stock in Krino site.

CONDIZIONI DI VENDITA

GENERAL SALES CONDITIONS

Le condizioni di seguito riportate si intendono accettate dal committente in fase di ordinazione.

1. ORDINI:

Con il conferimento dell'ordine si intendono approvate dal committente tutte le condizioni di vendita in vigore, salvo accordi particolari accettati dai contraenti. Tutti gli ordini sono irrevocabili da parte del committente ma potranno non essere da noi evasi a nostro insindacabile giudizio e senza obbligo di comunicazione o giustificazione. Nell'ordine è necessario specificare il codice dell'articolo.

2. PREZZI:

I prezzi si intendono per merce franco nostro magazzino (imballo, iva, trasporto esclusi) e non sono impegnativi. I prezzi che avranno valore saranno quelli in vigore al momento della spedizione.

3. IMBALLO:

Gratuito, salvo specifiche richieste del committente, che verranno fatturate al costo.

4. SPEDIZIONE:

Verrà effettuata come segue:

a) a mezzo nostro corriere di fiducia, in porto franco con addebito in fattura, in tal caso la merce sarà parzialmente assicurata** (vedere punto 10 dell'elenco);

b) a corriere di fiducia del committente: la resa sarà franco nostro stabilimento di Monticello e la merce viaggia a totale rischio e pericolo del committente. Pertanto in caso di ritardi, ammanchi, avaria, furti, etc. i reclami devono essere indirizzati al Vettore, solo ed unico responsabile.

5. CONSEGNE:

Il termine di consegna, qualora venisse indicato, è puramente indicativo e pertanto solleva la nostra società da ogni qualsivoglia rivalsa.

6. RECLAMI:

Debbono pervenire per iscritto entro 8 giorni dalla data di ricevimento merce. Trascorso tale termine, i reclami non verranno accettati. I reclami di qualsiasi natura non sospendono l'obbligo di effettuare i pagamenti nella forma convenuta. L'acquirente, nel caso che la merce sia da noi ritenuta non idonea, ha diritto esclusivamente alla sostituzione della stessa o all'accredito dell'importo. Ogni altro tipo di indennizzo si intende privo di valore. Per qualsiasi contestazione si elegge unico foro competente quello del Tribunale di Lecco.

7. RESI:

Ogni reso o sostituzione dovrà essere preventivamente autorizzato da KRINO SPA. La merce sarà accettata di ritorno, salvo verifica all'arrivo in magazzino. Questa dovrà essere inviata in porto franco e accompagnata dalla bolla di consegna con indicati gli estremi della fattura con la quale è stata precedentemente fornita.

8. PAGAMENTI:

Debbono essere effettuati esclusivamente alla nostra sede, secondo le forme concordate. Nel caso di ritardato pagamento, verranno addebitati gli interessi bancari dalla data di scadenza concordata sino all'avvenuto pagamento, maggiorati delle eventuali spese accessorie.

9. CARATTERISTICHE DEI PRODOTTI:

Le immagini contenute nel presente catalogo sono puramente indicative, pertanto la nostra azienda si riserva il diritto di apportare modifiche migliorative dei prodotti senza nessun obbligo di preavviso.

**LA RIPRODUZIONE ANCHE PARZIALE
DEL PRESENTE CATALOGO È VIETATA.**

10. VALORE DELL'ORDINE:

La spedizione verrà effettuata come segue:

- ordini singoli (non cumulabili) di importo superiore a Euro 600,00: spedizione in porto franco a mezzo nostro corriere di fiducia;
- ordini singoli (non cumulabili) di importo inferiore ad Euro 600,00: spedizione in porto franco con addebito in fattura di Euro 10,00;
- ordini singoli (non cumulabili) di importo inferiore ad Euro 100,00: spedizione in porto franco con addebito in fattura di Euro 10,00 + addebito di € 10 per oneri gestionali.

Riepilogando:

Valore ordine	Trasporto / Addebito	Oneri gestionali
Maggiore di Euro 600,00	Porto Franco	-
Minore di Euro 600,00	Euro 10,00	-
Minore di Euro 100,00	Euro 10,00	Euro 10,00

11. SERVIZIO RAPIDO:

- Per garantire il servizio, gli ordini devono essere inviati esclusivamente via email all'indirizzo: rapido@krino.it.
- Per ordini ricevuti entro le ore 10,00 viene garantita la spedizione il giorno lavorativo successivo, salvo indisponibilità del prodotto.
- Per ordini ricevuti dopo le ore 10,00 viene garantita la spedizione entro due giorni lavorativi, salvo indisponibilità del prodotto.
- Numero righe ordine non superiore a 10.
- Non è possibile effettuare aggiunte / modifiche all'ordine trasmesso.
- Possibilità di ritirare il materiale c/o la nostra sede, senza addebito.

1. ORDERS:

When an order is placed, all conditions are automatically accepted by the client. The order is irrevocable but we reserve the right to accept it. All orders should specify the items numbers.

2. PRICES:

All prices are ex works (packing, VAT and freight excluded).

3. PACKAGING:

Is free, a part of special requirements extra charged.

4. SHIPMENT:

It can be CIF with invoice charge, by parcel post or with a forwarding agent suggested by the customer.

5. DELIVERY TIME:

Is purely indicative.

6. CLAIMS:

They should be notified within 8 days from the date of goods receipt. We shall only arrange free replacement of the tools acknowledged as defective ones by us. In case of dispute, the Civil Court of LECCO will be competent.

7. GOODS RETURNED:

Any goods return should be authorized by us.

8. PAYMENTS:

to be made directly to our head office. In case of late payment, we charge the bank interest rate, including additional expenses.

9. PRODUCTS CHARACTERISTICS:

The images of this catalogue are purely indicatives, we reserve the right to make modifications without any notice.

THE REPRODUCTION OF THIS CATALOGUE IS PROHIBITED.

Any clause contained into your order sheets which is in contrast with the above mentioned conditions it is not valid.



KRINO S.P.A.
Via Italia Unita, 21
23876 Monticello Brianza (LC)
ITALY
info@krino.it
www.krino.it
www.lti-tools.it

VENDITE ITALIA
Tel. 039 9230611 (centralino)
Tel. 039 9230605 (Vendite Italia)
Fax 039 9208709 (Vendite Italia)
vendite.italia@krino.it

EXPORT SALES
Tel. +39 039 9230611 (Switch Board)
Tel. +39 039 9230604 (Export Sales)
Fax +39 039 9208712 (Export Sales)
export.sales@krino.it